

Elektrisch bediend
2-Weg NC
Messing magneetventiel

SIRAI L182 BIG HN



Sirai L182 Big HN

Sirai L182 BIG HN, Elektrisch bediend indirect werkend 2/2-weg messing magneetventiel NC (normaal gesloten) voorzien van hand nood bediening.

DOORLAAT

DN30 (1.1/4") tot DN45 (2")

AANSLUITING

- 2-Zijdig binnendraad volgens UNI EN 10226 (DIN ISO 7/1)

BEDRIJFSDRUK

Maximaal 15bar

TEMPERATUUR MEDIUM

Van:

- 10° tot +90°C (NBR)
- 0° tot +130°C (FPM)
- 10° tot +140°C (EPDM)

MATERIAAL

Huis: Messing
Membraan: NBR, EPDM of FPM
Inwendige delen: Messing en RVS
Kerngeleidebuis: RVS
Kortsluitring: Koper

DOORSTROMINGSRICHTING

Van P naar A.

MONTAGE

Magneetventiel kan in elke positie gemonteerd worden, voorkeur montage met de spoel verticaal naar boven gericht.

MEDIUM

Neutrale gasen en vloeistoffen. Voor toepassingen met agressieve media bestendigheidstabel raadplegen.

TECHNISCHE SPECIFICATIES

- Maximaal toelaatbare druk: 20bar
- Openigstijd: van ~300ms tot ~1500ms
- Sluittijd: van ~1000ms tot ~2000ms
- Maximale viscositeit: 5°E (~37 cStokes of mm²/s)

SIRAI L182 BIG HN

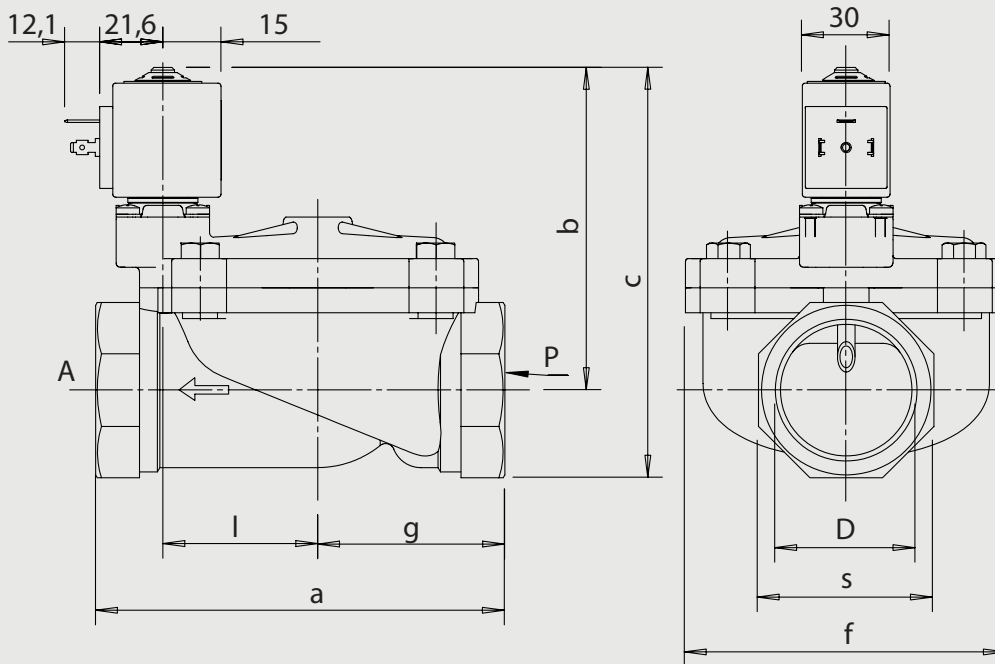

2/2 NC, NBR, 000/00

Sirai L182 2/2 weg indirectwerkend magneetventiel body elektrisch bediend 00 volt AC/DC

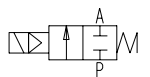

Doorlaat[mm] aansluiting[mm]		Druk (min)	Druk (max) Gas	Druk (max) Vloeistof	Kv	Spoel	Vermogen	Inbouwmaat [mm] en gewicht [kg]							Bestelcode	
DN	Rp							a	b	c	f	g	l	s		Gewicht
30	1.1/4	0,50	10	10	15			113	106	132	81	50	40	52	1,59	SL182BFGY
45	1.1/2	0,50	10	10	27			140	110	140	110	64	53	72	2,51	SL182BFHY
45	2	0,50	10	10	34			157	114	150	110	72	53	72	2,99	SL182BFJY

2/2 NC, NBR, 024V/DC

Sirai L182 2/2 weg indirectwerkend magneetventiel elektrisch bediend 24 volt DC

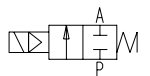

Doorlaat[mm] aansluiting[mm]		Druk (min)	Druk (max) Gas	Druk (max) Vloeistof	Kv	Spoel	Vermogen	Inbouwmaat [mm] en gewicht [kg]							Bestelcode	
DN	Rp							a	b	c	f	g	l	s		Gewicht
30	1.1/4	0,50	10	10	15	ZA10A	9W	113	106	132	81	50	40	52	1,59	SL182BFGYA10AF1
45	1.1/2	0,50	10	10	27	ZA10A	9W	140	110	140	110	64	53	72	2,51	SL182BFHYA10AF1
45	2	0,50	10	10	34	ZA10A	9W	157	114	150	110	72	53	72	2,99	SL182BFJYA10AF1

SIRAI L182 BIG HN

2/2 NC, NBR, 024V/50-60Hz

Sirai L182 2/2 weg indirectwerkend magneetventiel elektrisch bediend 24 volt AC

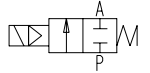

Doorlaat[mm] aansluiting[mm]		Druk (min)	Druk (max) Gas	Druk (max) Vloeistof	Kv	Spoel	Vermogen	Inbouwmaat [mm] en gewicht [kg]								Bestelcode
DN	Rp							a	b	c	f	g	l	s	Gewicht	
30	1.1/4	0,50	10	10	15	ZA10A	23-14VA	113	106	132	81	50	40	52	1,59	SL182BFGYA10AFL
45	1.1/2	0,50	10	10	27	ZA10A	23-14VA	140	110	140	110	64	53	72	2,51	SL182BFHYA10AFL
45	2	0,50	10	10	34	ZA10A	23-14VA	157	114	150	110	72	53	72	2,99	SL182BFJYA10AFL

2/2 NC, NBR, 230V/50-60Hz

Sirai L182 2/2 weg indirectwerkend magneetventiel elektrisch bediend 230 volt AC

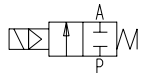

Doorlaat[mm] aansluiting[mm]		Druk (min)	Druk (max) Gas	Druk (max) Vloeistof	Kv	Spoel	Vermogen	Inbouwmaat [mm] en gewicht [kg]								Bestelcode
DN	Rp							a	b	c	f	g	l	s	Gewicht	
30	1.1/4	0,50	10	10	15	ZA10A	23-14VA	113	106	132	81	50	40	52	1,59	SL182BFGYA10AF8
45	1.1/2	0,50	10	10	27	ZA10A	23-14VA	140	110	140	110	64	53	72	2,51	SL182BFHYA10AF8
45	2	0,50	10	10	34	ZA10A	23-14VA	157	114	150	110	72	53	72	2,99	SL182BFJYA10AF8

2/2 NC, FPM, 000/00

Sirai L182 2/2 weg indirectwerkend magneetventiel body elektrisch bediend 00 volt AC/DC

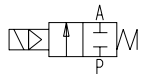

Doorlaat[mm] aansluiting[mm]		Druk (min)	Druk (max) Gas	Druk (max) Vloeistof	Kv	Spoel	Vermogen	Inbouwmaat [mm] en gewicht [kg]								Bestelcode
DN	Rp							a	b	c	f	g	l	s	Gewicht	
30	1.1/4	0,50	10	10	15			113	106	132	81	50	40	52	1,59	SL182VBGY
45	1.1/2	0,50	10	10	27			140	110	140	110	64	53	72	2,51	SL182VBHY

2/2 NC, FPM, 024V/DC

Sirai L182 2/2 weg indirectwerkend magneetventiel elektrisch bediend 24 volt DC

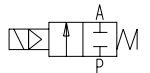

Doorlaat[mm] aansluiting[mm]		Druk (min)	Druk (max) Gas	Druk (max) Vloeistof	Kv	Spoel	Vermogen	Inbouwmaat [mm] en gewicht [kg]								Bestelcode
DN	Rp							a	b	c	f	g	l	s	Gewicht	
30	1.1/4	0,50	10	10	15	ZA10A	9W	113	106	132	81	50	40	52	1,59	SL182VBGYA10AF1
45	1.1/2	0,50	10	10	27	ZA10A	9W	140	110	140	110	64	53	72	2,51	SL182VBHYA10AF1

2/2 NC, FPM, 024V/50-60Hz

Sirai L182 2/2 weg indirectwerkend magneetventiel elektrisch bediend 24 volt AC

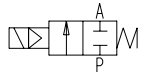

Doorlaat[mm] aansluiting[mm]		Druk (min)	Druk (max) Gas	Druk (max) Vloeistof	Kv	Spoel	Vermogen	Inbouwmaat [mm] en gewicht [kg]								Bestelcode
DN	Rp							a	b	c	f	g	l	s	Gewicht	
30	1.1/4	0,50	10	10	15	ZA10A	23-14VA	113	106	132	81	50	40	52	1,59	SL182VBGYA10AFL
45	1.1/2	0,50	10	10	27	ZA10A	23-14VA	140	110	140	110	64	53	72	2,51	SL182VBHYA10AFL

Elektrisch bediend
2-Weg NC
Messing magneetventiel

SIRAI L182 BIG HN

2/2 NC, FPM, 230V/50-60Hz

Sirai L182 2/2 weg indirectwerkend magneetventiel elektrisch bediend 230 volt AC

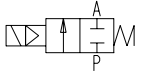

Doorlaat[mm] aansluiting[mm]		Druk (min)	Druk (max) Gas	Druk (max) Vloeistof	Kv	Spoel	Vermogen	Inbouwmaat [mm] en gewicht [kg]								Bestelcode
DN	Rp							a	b	c	f	g	l	s	Gewicht	
30	1.1/4	0,50	10	10	15	ZA10A	23-14VA	113	106	132	81	50	40	52	1,59	SL182VBGYA10AF8
45	1.1/2	0,50	10	10	27	ZA10A	23-14VA	140	110	140	110	64	53	72	2,51	SL182VBHYA10AF8