

2015



Professionals in
Flow & Fluid Technology

PNEUMATIEK

9

	KELM™ ISO 6432 rondcilinders - standaard & RVS	 Enhanced Quality Performance		Aignep compactcilinders	
	Pagina 518			Pagina 567	
	KELM™ Gen 2 ISO 15552 cilinders	 Enhanced Quality Performance		Flowregelaars	
	Pagina 528			Pagina 570	
	KELM™ ISO 15552 cilinders	 Enhanced Quality Performance		Aignep elektropneumatische ventielen	
	Pagina 532			Pagina 576	
	KELM™ compactcilinders	 Enhanced Quality Performance		Aignep luchtbediende ventielen	
	Pagina 539			Pagina 577	
	KELM™ hand- & mechanisch bediende ventielen	 Enhanced Quality Performance		Aignep handbediende ventielen	
	Pagina 546			Pagina 578	
	KELM™ luchtbediende ventielen	 Enhanced Quality Performance		Aignep magneetventielen	
	Pagina 551			Pagina 581	
	KELM™ elektrisch bediende ventielen	 Enhanced Quality Performance		Aircomp hand- & mechanisch bediende ventielen	
	Pagina 553			Pagina 582	
	KELM™ logic & specialist ventielen	 Enhanced Quality Performance		Aircomp luchtbediende ventielen	
	Pagina 556			Pagina 588	
	Aignep ISO 6432 rondcilinders - standaard & RVS			Aircomp elektropneumatische schuifventielen	
	Pagina 560			Pagina 589	
	Aignep ISO 15552 cilinders			Vacuümtechniek	
	Pagina 563			Pagina 594	

ISO 6432 persluchtcilinder

Accessoires en bevestiging selectie

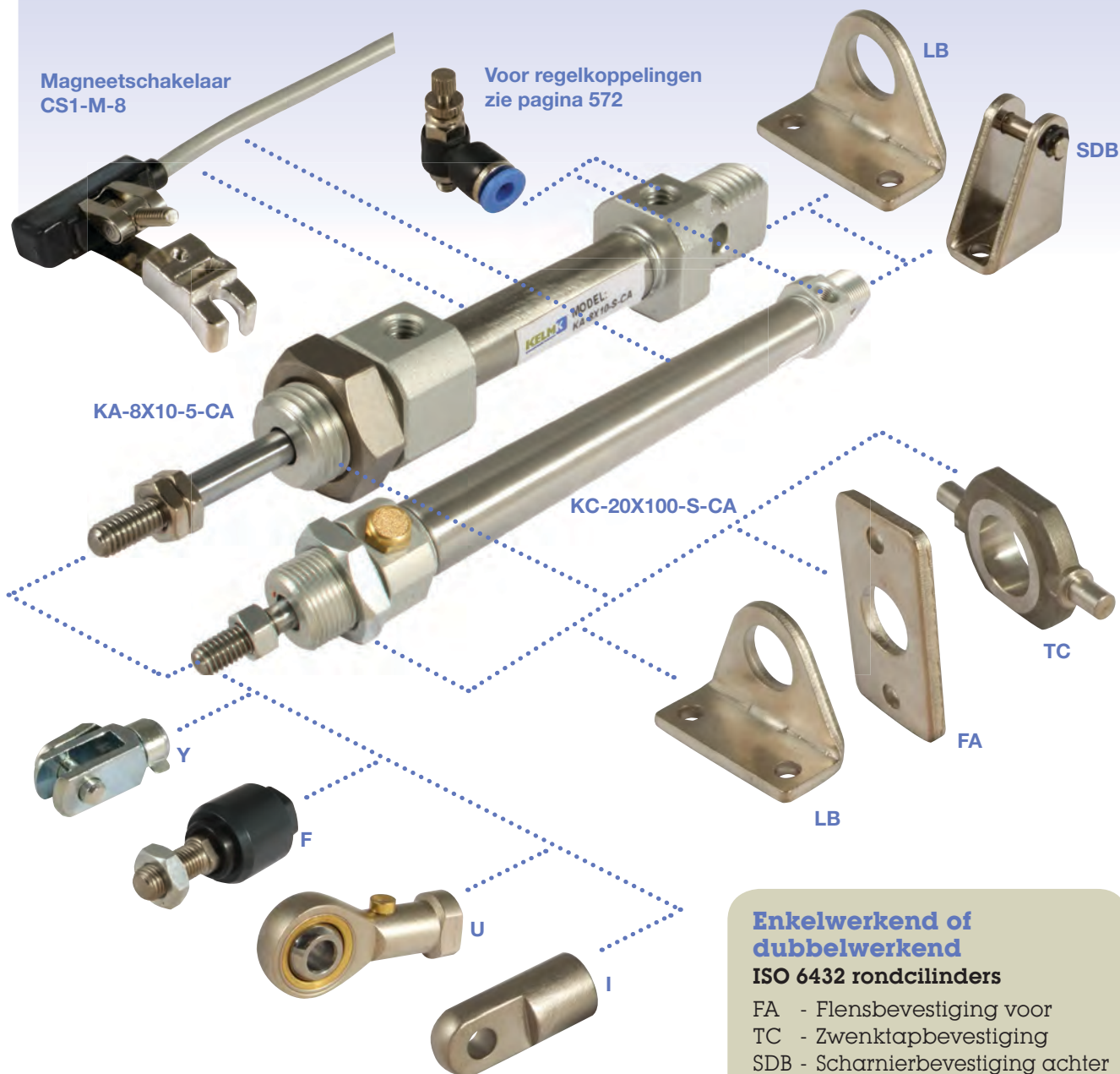

Magneetschakelaar
CS1-M-8

Voor regelkoppelingen
zie pagina 572

KA-8X10-5-CA

KC-20X100-S-CA

LB

SDB

Y

F

U

I

TC

FA

LB

Enkelwerkend of dubbelwerkend

ISO 6432 rondcilinders

- FA - Flensbevestiging voor
 - TC - Zwenktapbevestiging
 - SDB - Scharnierbevestiging achter
 - LB - Bevestigingsvoet (paar)
 - Y - Zuigerstang gaffel
 - I - Zuigerstang gaffel
 - F - Uittlijnkop
 - U - Universele kogelstangkop
- Tweepolige magneetschakelaars
N/O met LED

Cilinders

op pagina 520-522

Bevestigingen

op pagina 523

Magneetschakelaars

op pagina 523

ISO 6432 persluchtcilinder

Technische informatie



KA serie

CA type

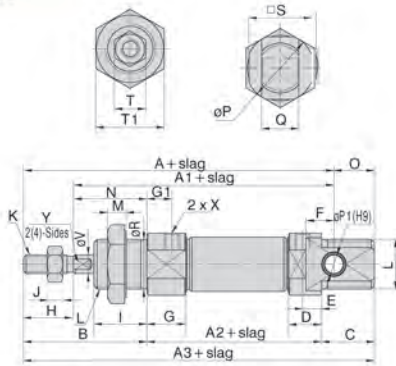

Boring	A	A1	A2	A3	A4	A5	A6	B	C	C1	C2	D	E	F	G	G1	H	I
8	76	64	46	86	74	-	-	28	12	9.5	5	9.5	5	6	11.5	7	12	12
10	76	64	46	86	74	-	-	28	12	9.5	5	9.5	5	6	11.5	7	12	12
12	91	75	50	105	88	-	-	38	17	10.5	6	10.5	6	9	12.5	8	16	17
16	98	82	56	111	94	111	94	38	17	10.5	6	10.5	6	9	12.5	8	16	17
20	115	95	62	126	106	126	106	44	20	14.5	7.5	14.5	7.5	12	14.5	7.5	20	20
25	126	104	65	137	114.5	137	115	50	22	16	8	16	8	12	16	8	22	22
32	-	-	-	-	-	125	140	126	58	14	16.5	9	-	-	16.5	9	20	30
40	-	-	-	-	158	174	158	69	16	22	12	-	-	-	22	12	24	35

Boring	J	K	L	M	N	O	P	P1	Q	R	S	T	T1	X	V	W	Y
8	2.5	M4 x 0.7	M12 x 1.25	6	16	10	17	4	8	12	15	7	17	M5 x 0.8	4	-	-
10	2.5	M4 x 0.7	M12 x 1.25	6	16	10	17	4	8	12	15	7	17	M5 x 0.8	4	-	-
12	5	M6 x 1.0	M16 x 1.5	6	22	14	20	6	12	16	18	10	22	M5 x 0.8	6	-	5
16	5	M6 x 1.0	M16 x 1.5	6	22	13	22	6	12	16	20	10	22	M5 x 0.8	6	13.5	5
20	6	M8 x 1.25	M22 x 1.5	7	24	11	29	8	16	22	25	12	29	1/8"	8	16.5	6
25	6	M10 x 1.25	M22 x 1.5	7	28	11	33.5	8	16	22	30	17	29	1/8"	10	18.5	8
32	6	M10 x 1.25	M30 x 1.5	7	38	-	37.5	-	30	34.5	17	36	1/8"	12	10.5	10	10
40	7	M12 x 1.25	M38 x 1.5	8	45	-	46.5	-	38	42.5	17	46	1/4"	16	12.5	14	14

KB serie

ø16 - ø25

Boring	A	A1	A2	A3	A4	A5	B	C	D
16	98	82	56	111	94	111	38	17	12.1
20	115	95	62	126	106	126	44	20	14.5
25	126	104	65	137	113.5	137	50	22	16

Boring	D1	D2	D3	E	F	G	G1	G2
16	7	9	12.1	6	9	12.5	7.5	9.5
20	7.5	10.5	14.5	8	12	14.5	7.5	10.5
25	8	10.5	14.5	8	12	16	8	12

Boring	H	I	J	K	L	M	O	N
16	16	17	5	M6 x 1.0	M16 x 1.5	6	13	22
20	20	20	6	M8 x 1.25	M22 x 1.5	7	11	24
25	22	22	6	M10 x 1.25	M22 x 1.5	7	11	28

Boring	P	Q	R	S	T	T1	V	W	X
16	22	12	5	20	10	22	6	13.5	M5 x 0.8
20	29	16	6	25	12	29	8	16.5	1/8"
25	33.5	16	9	30	17	29	10	18.5	1/8"

ø32, ø40

Boring	A2	A4	A5	B	C	D	D1	D2	D3	D4
32	68	124	140	58	14	16.5	9	11.5	14.5	7.5
40	89	157.5	174	69	16	22	12	12	21.5	11.5

Boring	D5	G	G1	G2	H	I	J	K
32	11	16.5	9	11.8	20	30	6	M10 x 1.25
40	14	22	12	12	24	35	7	M12 x 1.25

Boring	L	M	N	P	S	T	T1	V	W	X
32	M30 x 1.5	7	38	37.5	34.5	17	36	12	10.5	1/8"
40	M38 x 1.5	8	45	46.5	42.5	17	46	16	12.5	1/4"

KC serie

CA type

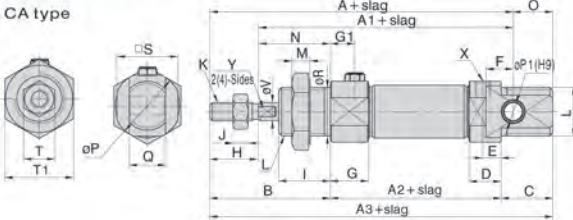

Binnenstructuur



Nr.	Omschrijving	Materiaal
1	Slag	5 - 12 (Boring) 18 - 40 (Boring)
2	Zuigerstangmoer	Kunststof
3	Pakking kap voorzijde	NBR
4	Moer kap voorzijde	Kunststof
5	Capsteen	Stijf materiaal
6	Kap voorzijde	Aluminiumlegering
7	Bus	Staal
8	Buter	TPU
9	Zuiger	303 Aluminiumlegering
10	Chengzuiger	NBR
11	Sliding	Stijf materiaal
12	Moer	Kunststof
13	Kap achterzijde	Aluminiumlegering

CM type

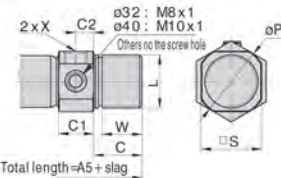

Boring	A			A1		
	0-50	51-100	101-150	0-50	51-100	101-150
8	101	-	-	89	-	-
10	101	-	-	89	-	-
12	116	-	-	100	-	-
16	123	148	-	107	132	-
20	140	165	190	120	145	170
25	151	176	201	129	154	179
32	-	-	-	-	-	-
40	-	-	-	-	-	-

Boring	A4			A5		
	0-50	51-100	101-150	0-50	51-100	101-150
8	99	-	-	-	-	-
10	99	-	-	-	-	-
12	113	-	-	-	-	-
16	119	144	-	136	161	-
20	131	156	181	151	176	201
25	139.5	164.5	189.5	162	187	212
32	150	175	200	165	190	215
40	183	208	233	199	224	249

Boring	A2			A3		
	0-50	51-100	101-150	0-50	51-100	101-150
8	71	-	-	111	-	-
10	71	-	-	111	-	-
12	75	-	-	130	-	-
16	81	106	-	136	161	-
20	87	112	137	151	176	201
25	90	115	140	162	187	212
32	-	-	-	-	-	-
40	-	-	-	-	-	-

Boring	A6			
	0-50	51-100	101-150	B C C1 C2
8	-	-	-	28 12 9.5 5
10	-	-	-	28 12 9.5 5
12	-	-	-	38 17 10.5 6
16	119	144	-	38 17 10.5 6
20	131	156	181	44 20 14.5 7.5
25	140	165	190	50 22 16 8
32	151	176	201	58 14 16.5 9
40	183	208	233	69 16 22 12

ISO 6432 rondcilinders

Werktemperatuur:
-20°C tot +70°C

Werkdruk:
2 tot 10 bar

Medium:

Geconditioneerde perslucht, gefilterd (40µm) en gesmeerd.

Met kunststof buffers

Volledige technische specificaties worden op aanvraag verstrekt

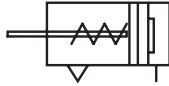

Tech Data
3000

Magnetisch - enkelwerkend

0334	mm	mm			Rod Thread	€
KC-8X10-S-CA	8	10	M5	M12 x 1,25	M4 x 0,7	28.50
KC-8X15-S-CA	8	15	M5	M12 x 1,25	M4 x 0,7	28.50
KC-8X20-S-CA	8	20	M5	M12 x 1,25	M4 x 0,7	28.50
KC-8X25-S-CA	8	25	M5	M12 x 1,25	M4 x 0,7	28.50
KC-8X30-S-CA	8	30	M5	M12 x 1,25	M4 x 0,7	29.55
KC-8X40-S-CA	8	40	M5	M12 x 1,25	M4 x 0,7	29.55
KC-8X50-S-CA	8	50	M5	M12 x 1,25	M4 x 0,7	29.55
KC-10X10-S-CA	10	10	M5	M12 x 1,25	M4 x 0,7	29.55
KC-10X15-S-CA	10	15	M5	M12 x 1,25	M4 x 0,7	29.55
KC-10X20-S-CA	10	20	M5	M12 x 1,25	M4 x 0,7	29.55
KC-10X25-S-CA	10	25	M5	M12 x 1,25	M4 x 0,7	29.55
KC-10X30-S-CA	10	30	M5	M12 x 1,25	M4 x 0,7	31.25
KC-10X40-S-CA	10	40	M5	M12 x 1,25	M4 x 0,7	31.25
KC-10X50-S-CA	10	50	M5	M12 x 1,25	M4 x 0,7	31.25
KC-12X10-S-CA	12	10	M5	M16 x 1,5	M6 x 1,0	34.55
KC-12X15-S-CA	12	15	M5	M16 x 1,5	M6 x 1,0	34.55
KC-12X20-S-CA	12	20	M5	M16 x 1,5	M6 x 1,0	34.55
KC-12X25-S-CA	12	25	M5	M16 x 1,5	M6 x 1,0	34.55
KC-12X30-S-CA	12	30	M5	M16 x 1,5	M6 x 1,0	36.30
KC-12X40-S-CA	12	40	M5	M16 x 1,5	M6 x 1,0	36.30
KC-12X50-S-CA	12	50	M5	M16 x 1,5	M6 x 1,0	36.30
KC-16X10-S-CA	16	10	M5	M16 x 1,5	M6 x 1,0	40.80
KC-16X15-S-CA	16	15	M5	M16 x 1,5	M6 x 1,0	42.55
KC-16X20-S-CA	16	20	M5	M16 x 1,5	M6 x 1,0	42.55
KC-16X25-S-CA	16	25	M5	M16 x 1,5	M6 x 1,0	42.55
KC-16X30-S-CA	16	30	M5	M16 x 1,5	M6 x 1,0	44.00
KC-16X40-S-CA	16	40	M5	M16 x 1,5	M6 x 1,0	45.45
KC-16X50-S-CA	16	50	M5	M16 x 1,5	M6 x 1,0	45.45
KC-16X60-S-CA	16	60	M5	M16 x 1,5	M6 x 1,0	46.85
KC-16X75-S-CA	16	75	M5	M16 x 1,5	M6 x 1,0	46.85
KC-16X80-S-CA	16	80	M5	M16 x 1,5	M6 x 1,0	49.75
KC-16X100-S-CA	16	100	M5	M16 x 1,5	M6 x 1,0	49.75
KC-20X10-S-CA	20	10	1/8"	M22 x 1,5	M8 x 1,25	46.80
KC-20X15-S-CA	20	15	1/8"	M22 x 1,5	M8 x 1,25	46.80
KC-20X20-S-CA	20	20	1/8"	M22 x 1,5	M8 x 1,25	49.00
KC-20X25-S-CA	20	25	1/8"	M22 x 1,5	M8 x 1,25	49.00
KC-20X30-S-CA	20	30	1/8"	M22 x 1,5	M8 x 1,25	49.60
KC-20X40-S-CA	20	40	1/8"	M22 x 1,5	M8 x 1,25	49.60
KC-20X50-S-CA	20	50	1/8"	M22 x 1,5	M8 x 1,25	49.60
KC-20X60-S-CA	20	60	1/8"	M22 x 1,5	M8 x 1,25	52.70
KC-20X75-S-CA	20	75	1/8"	M22 x 1,5	M8 x 1,25	52.70
KC-20X80-S-CA	20	80	1/8"	M22 x 1,5	M8 x 1,25	57.30

0334	mm	mm			Rod Thread	€
KC-20X100-S-CA	20	100	1/8"	M22 x 1,5	M8 x 1,25	57.30
KC-20X125-S-CA	20	125	1/8"	M22 x 1,5	M8 x 1,25	58.55
KC-20X150-S-CA	20	150	1/8"	M22 x 1,5	M8 x 1,25	61.35
KC-25X10-S-CA	25	10	1/8"	M22 x 1,5	M10 x 1,25	53.05
KC-25X15-S-CA	25	15	1/8"	M22 x 1,5	M10 x 1,25	53.05
KC-25X20-S-CA	25	20	1/8"	M22 x 1,5	M10 x 1,25	53.05
KC-25X25-S-CA	25	25	1/8"	M22 x 1,5	M10 x 1,25	53.05
KC-25X30-S-CA	25	30	1/8"	M22 x 1,5	M10 x 1,25	57.05
KC-25X40-S-CA	25	40	1/8"	M22 x 1,5	M10 x 1,25	57.05
KC-25X50-S-CA	25	50	1/8"	M22 x 1,5	M10 x 1,25	57.05
KC-25X60-S-CA	25	60	1/8"	M22 x 1,5	M10 x 1,25	59.90
KC-25X75-S-CA	25	75	1/8"	M22 x 1,5	M10 x 1,25	59.90
KC-25X80-S-CA	25	80	1/8"	M22 x 1,5	M10 x 1,25	65.00
KC-25X100-S-CA	25	100	1/8"	M22 x 1,5	M10 x 1,25	65.00
KC-25X125-S-CA	25	125	1/8"	M22 x 1,5	M10 x 1,25	65.35
KC-25X150-S-CA	25	150	1/8"	M22 x 1,5	M10 x 1,25	68.50
KC-32X10-S-CM	32	10	1/8"	M30 x 1,5	M10 x 1,25	72.05
KC-32X15-S-CM	32	15	1/8"	M30 x 1,5	M10 x 1,25	72.05
KC-32X20-S-CM	32	20	1/8"	M30 x 1,5	M10 x 1,25	72.05
KC-32X25-S-CM	32	25	1/8"	M30 x 1,5	M10 x 1,25	72.05
KC-32X30-S-CM	32	30	1/8"	M30 x 1,5	M10 x 1,25	77.05
KC-32X40-S-CM	32	40	1/8"	M30 x 1,5	M10 x 1,25	77.05
KC-32X50-S-CM	32	50	1/8"	M30 x 1,5	M10 x 1,25	77.05
KC-32X60-S-CM	32	60	1/8"	M30 x 1,5	M10 x 1,25	82.25
KC-32X75-S-CM	32	75	1/8"	M30 x 1,5	M10 x 1,25	82.25
KC-32X80-S-CM	32	80	1/8"	M30 x 1,5	M10 x 1,25	87.20
KC-32X100-S-CM	32	100	1/8"	M30 x 1,5	M10 x 1,25	87.20
KC-32X125-S-CM	32	125	1/8"	M30 x 1,5	M10 x 1,25	92.20
KC-32X150-S-CM	32	150	1/8"	M30 x 1,5	M10 x 1,25	97.05
KC-40X10-S-CM	40	10	1/4"	M38 x 1,5	M12 x 1,25	87.50
KC-40X15-S-CM	40	15	1/4"	M38 x 1,5	M12 x 1,25	87.50
KC-40X20-S-CM	40	20	1/4"	M38 x 1,5	M12 x 1,25	87.50
KC-40X25-S-CM	40	25	1/4"	M38 x 1,5	M12 x 1,25	87.50
KC-40X30-S-CM	40	30	1/4"	M38 x 1,5	M12 x 1,25	93.80
KC-40X40-S-CM	40	40	1/4"	M38 x 1,5	M12 x 1,25	93.80
KC-40X50-S-CM	40	50	1/4"	M38 x 1,5	M12 x 1,25	93.80
KC-40X60-S-CM	40	60	1/4"	M38 x 1,5	M12 x 1,25	100.50
KC-40X75-S-CM	40	75	1/4"	M38 x 1,5	M12 x 1,25	100.50
KC-40X80-S-CM	40	80	1/4"	M38 x 1,5	M12 x 1,25	106.95
KC-40X100-S-CM	40	100	1/4"	M38 x 1,5	M12 x 1,25	106.95
KC-40X125-S-CM	40	125	1/4"	M38 x 1,5	M12 x 1,25	113.30
KC-40X150-S-CM	40	150	1/4"	M38 x 1,5	M12 x 1,25	119.95

KELM™
pneumatiek

Hydrauliek

Snel-
koppelingen

Afsluiters

Roestvast
staal

Fittingen

Lucht-
conditionering

Gereedschap

Pneumatiek

Diversen

Malleerbare
fittingen
& staal

Ringleiding-
systemen

Slangen

Compressoren

Perslucht cilinders

ISO 6432 rondcilinders

Werktemperatuur:
-20°C tot +70°C

Werkdruk:
1 tot 10 bar

Medium:

Geconditioneerde perslucht, gefilterd (40µm) en gesmeerd.

Type KA: met kunststof buffers

Type KB: met instelbare buffering

Volledige technische specificaties worden op aanvraag verstrekt

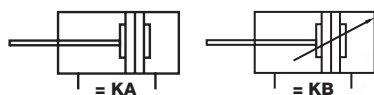

Tech Data
3001

Magnetisch - dubbelwerkend

Raadpleeg de volgende pagina voor andere maten in deze reeks

0334					
KA-8X10-S-CA	8	10	M5	M12 x 1,25 M4 x 0,7	24.15
KA-8X15-S-CA	8	15	M5	M12 x 1,25 M4 x 0,7	24.15
KA-8X20-S-CA	8	20	M5	M12 x 1,25 M4 x 0,7	24.15
KA-8X25-S-CA	8	25	M5	M12 x 1,25 M4 x 0,7	24.15
KA-8X30-S-CA	8	30	M5	M12 x 1,25 M4 x 0,7	25.20
KA-8X40-S-CA	8	40	M5	M12 x 1,25 M4 x 0,7	25.20
KA-8X50-S-CA	8	50	M5	M12 x 1,25 M4 x 0,7	25.20
KA-8X60-S-CA	8	60	M5	M12 x 1,25 M4 x 0,7	26.15
KA-8X75-S-CA	8	75	M5	M12 x 1,25 M4 x 0,7	26.15
KA-8X80-S-CA	8	80	M5	M12 x 1,25 M4 x 0,7	27.30
KA-8X100-S-CA	8	100	M5	M12 x 1,25 M4 x 0,7	27.30
KA-8X125-S-CA	8	125	M5	M12 x 1,25 M4 x 0,7	28.60
KA-8X150-S-CA	8	150	M5	M12 x 1,25 M4 x 0,7	29.80
KA-10X10-S-CA	10	10	M5	M12 x 1,25 M4 x 0,7	25.20
KA-10X15-S-CA	10	15	M5	M12 x 1,25 M4 x 0,7	25.20
KA-10X20-S-CA	10	20	M5	M12 x 1,25 M4 x 0,7	25.20
KA-10X25-S-CA	10	25	M5	M12 x 1,25 M4 x 0,7	25.20
KA-10X30-S-CA	10	30	M5	M12 x 1,25 M4 x 0,7	26.30
KA-10X40-S-CA	10	40	M5	M12 x 1,25 M4 x 0,7	26.30
KA-10X50-S-CA	10	50	M5	M12 x 1,25 M4 x 0,7	26.30
KA-10X60-S-CA	10	60	M5	M12 x 1,25 M4 x 0,7	28.10
KA-10X75-S-CA	10	75	M5	M12 x 1,25 M4 x 0,7	28.10
KA-10X80-S-CA	10	80	M5	M12 x 1,25 M4 x 0,7	29.35
KA-10X100-S-CA	10	100	M5	M12 x 1,25 M4 x 0,7	29.35
KA-10X125-S-CA	10	125	M5	M12 x 1,25 M4 x 0,7	31.30
KA-10X150-S-CA	10	150	M5	M12 x 1,25 M4 x 0,7	33.00
KA-10X160-S-CA	10	160	M5	M12 x 1,25 M4 x 0,7	34.40
KA-10X175-S-CA	10	175	M5	M12 x 1,25 M4 x 0,7	34.40
KA-10X200-S-CA	10	200	M5	M12 x 1,25 M4 x 0,7	36.15
KA-12X10-S-CA	12	10	M5	M16 x 1,5 M6 x 1,0	29.65
KA-12X15-S-CA	12	15	M5	M16 x 1,5 M6 x 1,0	29.65
KA-12X20-S-CA	12	20	M5	M16 x 1,5 M6 x 1,0	29.65
KA-12X25-S-CA	12	25	M5	M16 x 1,5 M6 x 1,0	30.30
KA-12X30-S-CA	12	30	M5	M16 x 1,5 M6 x 1,0	31.05
KA-12X40-S-CA	12	40	M5	M16 x 1,5 M6 x 1,0	31.05
KA-12X50-S-CA	12	50	M5	M16 x 1,5 M6 x 1,0	31.05
KA-12X60-S-CA	12	60	M5	M16 x 1,5 M6 x 1,0	33.00
KA-12X75-S-CA	12	75	M5	M16 x 1,5 M6 x 1,0	33.00
KA-12X80-S-CA	12	80	M5	M16 x 1,5 M6 x 1,0	34.40
KA-12X100-S-CA	12	100	M5	M16 x 1,5 M6 x 1,0	34.40
KA-12X125-S-CA	12	125	M5	M16 x 1,5 M6 x 1,0	35.75
KA-12X150-S-CA	12	150	M5	M16 x 1,5 M6 x 1,0	38.10
KA-12X160-S-CA	12	160	M5	M16 x 1,5 M6 x 1,0	41.05
KA-12X175-S-CA	12	175	M5	M16 x 1,5 M6 x 1,0	41.05
KA-12X200-S-CA	12	200	M5	M16 x 1,5 M6 x 1,0	41.60
KA-12X250-S-CA	12	250	M5	M16 x 1,5 M6 x 1,0	45.55
KB-16X10-S-CA	16	10	M5	M16 x 1,5 M6 x 1,0	47.70
KB-16X15-S-CA	16	15	M5	M16 x 1,5 M6 x 1,0	47.70
KB-16X20-S-CA	16	20	M5	M16 x 1,5 M6 x 1,0	47.70
KB-16X25-S-CA	16	25	M5	M16 x 1,5 M6 x 1,0	47.70

0334					
KB-16X30-S-CA	16	30	M5	M16 x 1,5 M6 x 1,0	49.85
KB-16X40-S-CA	16	40	M5	M16 x 1,5 M6 x 1,0	49.85
KB-16X50-S-CA	16	50	M5	M16 x 1,5 M6 x 1,0	51.85
KB-16X60-S-CA	16	60	M5	M16 x 1,5 M6 x 1,0	51.85
KB-16X75-S-CA	16	75	M5	M16 x 1,5 M6 x 1,0	51.85
KB-16X80-S-CA	16	80	M5	M16 x 1,5 M6 x 1,0	55.05
KB-16X100-S-CA	16	100	M5	M16 x 1,5 M6 x 1,0	55.05
KB-16X125-S-CA	16	125	M5	M16 x 1,5 M6 x 1,0	54.80
KB-16X150-S-CA	16	150	M5	M16 x 1,5 M6 x 1,0	59.35
KB-16X160-S-CA	16	160	M5	M16 x 1,5 M6 x 1,0	60.70
KB-16X175-S-CA	16	175	M5	M16 x 1,5 M6 x 1,0	60.70
KB-16X200-S-CA	16	200	M5	M16 x 1,5 M6 x 1,0	61.05
KB-16X250-S-CA	16	250	M5	M16 x 1,5 M6 x 1,0	66.05
KB-16X300-S-CA	16	300	M5	M16 x 1,5 M6 x 1,0	70.45
KB-20X10-S-CA	20	10	1/8"	M22 x 1,5 M8 x 1,25	53.30
KB-20X15-S-CA	20	15	1/8"	M22 x 1,5 M8 x 1,25	53.30
KB-20X20-S-CA	20	20	1/8"	M22 x 1,5 M8 x 1,25	53.30
KB-20X25-S-CA	20	25	1/8"	M22 x 1,5 M8 x 1,25	54.60
KB-20X30-S-CA	20	30	1/8"	M22 x 1,5 M8 x 1,25	57.10
KB-20X40-S-CA	20	40	1/8"	M22 x 1,5 M8 x 1,25	57.10
KB-20X50-S-CA	20	50	1/8"	M22 x 1,5 M8 x 1,25	57.10
KB-20X60-S-CA	20	60	1/8"	M22 x 1,5 M8 x 1,25	60.15
KB-20X75-S-CA	20	75	1/8"	M22 x 1,5 M8 x 1,25	60.15
KB-20X80-S-CA	20	80	1/8"	M22 x 1,5 M8 x 1,25	60.15
KB-20X100-S-CA	20	100	1/8"	M22 x 1,5 M8 x 1,25	62.40
KB-20X125-S-CA	20	125	1/8"	M22 x 1,5 M8 x 1,25	66.05
KB-20X150-S-CA	20	150	1/8"	M22 x 1,5 M8 x 1,25	66.05
KB-20X160-S-CA	20	160	1/8"	M22 x 1,5 M8 x 1,25	68.65
KB-20X175-S-CA	20	175	1/8"	M22 x 1,5 M8 x 1,25	68.65
KB-20X200-S-CA	20	200	1/8"	M22 x 1,5 M8 x 1,25	70.15
KB-20X250-S-CA	20	250	1/8"	M22 x 1,5 M8 x 1,25	76.50
KB-20X300-S-CA	20	300	1/8"	M22 x 1,5 M8 x 1,25	81.95
KB-20X350-S-CA	20	350	1/8"	M22 x 1,5 M8 x 1,25	89.05
KB-20X400-S-CA	20	400	1/8"	M22 x 1,5 M8 x 1,25	95.20
KB-20X450-S-CA	20	450	1/8"	M22 x 1,5 M8 x 1,25	101.50
KB-20X500-S-CA	20	500	1/8"	M22 x 1,5 M8 x 1,25	107.65
KB-25X10-S-CA	25	10	1/8"	M22 x 1,5 M10 x 1,25	59.40
KB-25X15-S-CA	25	15	1/8"	M22 x 1,5 M10 x 1,25	59.40
KB-25X20-S-CA	25	20	1/8"	M22 x 1,5 M10 x 1,25	59.40
KB-25X25-S-CA	25	25	1/8"	M22 x 1,5 M10 x 1,25	59.40
KB-25X30-S-CA	25	30	1/8"	M22 x 1,5 M10 x 1,25	63.85
KB-25X40-S-CA	25	40	1/8"	M22 x 1,5 M10 x 1,25	63.85
KB-25X50-S-CA	25	50	1/8"	M22 x 1,5 M10 x 1,25	65.00
KB-25X60-S-CA	25	60	1/8"	M22 x 1,5 M10 x 1,25	65.00
KB-25X75-S-CA	25	75	1/8"	M22 x 1,5 M10 x 1,25	67.95
KB-25X80-S-CA	25	80	1/8"	M22 x 1,5 M10 x 1,25	67.95
KB-25X100-S-CA	25	100	1/8"	M22 x 1,5 M10 x 1,25	68.15

KELMK™
pneumatiek

Hydrauliek

Snel-
koppelingen

Afsluiters

Roestvast
staal

Fittingen

Lucht-
conditionering

Gereedschap

Pneumatiek

Diversen

Malleabele
fittingen
& staal

Ringleiding-
systemen

Slangen

Compressoren

Perslucht cilinders



ISO 6432 rondcilinders

Werktemperatuur:
-20°C tot +70°C

Werkdruk:
1 tot 10 bar

Medium:

Geconditioneerde perslucht, gefilterd (40µm) en gesmeerd.

Type KA: met kunststof buffers

Type KB: met instelbare buffering

Volledige technische specificaties worden op aanvraag verstrekt

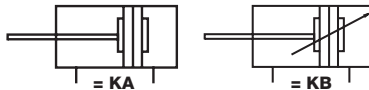

Tech Data
3001

Magnetisch - dubbelwerkend

0334	mm	mm	mm	A	Rod Thread	€
KB-25X125-S-CA	25	125	1/8"	M22 x 1,5	M10 x 1,25	72.55
KB-25X150-S-CA	25	150	1/8"	M22 x 1,5	M10 x 1,25	74.75
KB-25X160-S-CA	25	160	1/8"	M22 x 1,5	M10 x 1,25	78.85
KB-25X175-S-CA	25	175	1/8"	M22 x 1,5	M10 x 1,25	76.75
KB-25X200-S-CA	25	200	1/8"	M22 x 1,5	M10 x 1,25	81.85
KB-25X250-S-CA	25	250	1/8"	M22 x 1,5	M10 x 1,25	91.45
KB-25X300-S-CA	25	300	1/8"	M22 x 1,5	M10 x 1,25	91.15
KB-25X350-S-CA	25	350	1/8"	M22 x 1,5	M10 x 1,25	98.15
KB-25X400-S-CA	25	400	1/8"	M22 x 1,5	M10 x 1,25	102.00
KB-25X450-S-CA	25	450	1/8"	M22 x 1,5	M10 x 1,25	109.30
KB-25X500-S-CA	25	500	1/8"	M22 x 1,5	M10 x 1,25	119.35
KB-25X600-S-CA	25	600	1/8"	M22 x 1,5	M10 x 1,25	131.25
KB-32X10-S-CM	32	10	1/8"	M30 x 1,5	M10 x 1,25	78.90
KB-32X15-S-CM	32	15	1/8"	M30 x 1,5	M10 x 1,25	78.90
KB-32X20-S-CM	32	20	1/8"	M30 x 1,5	M10 x 1,25	78.90
KB-32X25-S-CM	32	25	1/8"	M30 x 1,5	M10 x 1,25	78.90
KB-32X30-S-CM	32	30	1/8"	M30 x 1,5	M10 x 1,25	83.10
KB-32X40-S-CM	32	40	1/8"	M30 x 1,5	M10 x 1,25	83.10
KB-32X50-S-CM	32	50	1/8"	M30 x 1,5	M10 x 1,25	83.10
KB-32X60-S-CM	32	60	1/8"	M30 x 1,5	M10 x 1,25	87.40
KB-32X75-S-CM	32	75	1/8"	M30 x 1,5	M10 x 1,25	87.40
KB-32X80-S-CM	32	80	1/8"	M30 x 1,5	M10 x 1,25	91.90
KB-32X100-S-CM	32	100	1/8"	M30 x 1,5	M10 x 1,25	91.90
KB-32X125-S-CM	32	125	1/8"	M30 x 1,5	M10 x 1,25	96.20
KB-32X150-S-CM	32	150	1/8"	M30 x 1,5	M10 x 1,25	100.50
KB-32X160-S-CM	32	160	1/8"	M30 x 1,5	M10 x 1,25	104.85
KB-32X175-S-CM	32	175	1/8"	M30 x 1,5	M10 x 1,25	104.85
KB-32X200-S-CM	32	200	1/8"	M30 x 1,5	M10 x 1,25	109.05
KB-32X250-S-CM	32	250	1/8"	M30 x 1,5	M10 x 1,25	117.55

0334	mm	mm	mm	A	Rod Thread	€
KB-32X300-S-CM	32	300	1/8"	M30 x 1,5	M10 x 1,25	126.80
KB-32X350-S-CM	32	350	1/8"	M30 x 1,5	M10 x 1,25	135.55
KB-32X400-S-CM	32	400	1/8"	M30 x 1,5	M10 x 1,25	144.90
KB-32X450-S-CM	32	450	1/8"	M30 x 1,5	M10 x 1,25	154.20
KB-32X500-S-CM	32	500	1/8"	M30 x 1,5	M10 x 1,25	163.45
KB-32X600-S-CM	32	600	1/8"	M30 x 1,5	M10 x 1,25	181.60
KB-40X10-S-CM	40	10	1/4"	M38 x 1,5	M12 x 1,25	93.65
KB-40X15-S-CM	40	15	1/4"	M38 x 1,5	M12 x 1,25	93.65
KB-40X20-S-CM	40	20	1/4"	M38 x 1,5	M12 x 1,25	93.65
KB-40X25-S-CM	40	25	1/4"	M38 x 1,5	M12 x 1,25	93.65
KB-40X30-S-CM	40	30	1/4"	M38 x 1,5	M12 x 1,25	99.45
KB-40X40-S-CM	40	40	1/4"	M38 x 1,5	M12 x 1,25	99.45
KB-40X50-S-CM	40	50	1/4"	M38 x 1,5	M12 x 1,25	99.45
KB-40X60-S-CM	40	60	1/4"	M38 x 1,5	M12 x 1,25	105.05
KB-40X75-S-CM	40	75	1/4"	M38 x 1,5	M12 x 1,25	105.05
KB-40X80-S-CM	40	80	1/4"	M38 x 1,5	M12 x 1,25	110.80
KB-40X100-S-CM	40	100	1/4"	M38 x 1,5	M12 x 1,25	110.80
KB-40X125-S-CM	40	125	1/4"	M38 x 1,5	M12 x 1,25	116.40
KB-40X150-S-CM	40	150	1/4"	M38 x 1,5	M12 x 1,25	121.20
KB-40X160-S-CM	40	160	1/4"	M38 x 1,5	M12 x 1,25	127.65
KB-40X175-S-CM	40	175	1/4"	M38 x 1,5	M12 x 1,25	127.65
KB-40X200-S-CM	40	200	1/4"	M38 x 1,5	M12 x 1,25	133.25
KB-40X250-S-CM	40	250	1/4"	M38 x 1,5	M12 x 1,25	150.40
KB-40X300-S-CM	40	300	1/4"	M38 x 1,5	M12 x 1,25	161.90
KB-40X350-S-CM	40	350	1/4"	M38 x 1,5	M12 x 1,25	173.75
KB-40X400-S-CM	40	400	1/4"	M38 x 1,5	M12 x 1,25	185.60
KB-40X450-S-CM	40	450	1/4"	M38 x 1,5	M12 x 1,25	197.45
KB-40X500-S-CM	40	500	1/4"	M38 x 1,5	M12 x 1,25	209.80
KB-40X600-S-CM	40	600	1/4"	M38 x 1,5	M12 x 1,25	234.00

ISO 6432 bevestigingen

Tech Data
3002



Flensbevestiging voor 'FA'

0334	mm	€
F-KA8FA	8/10	1.60
F-KA12FA	12/16	1.75
F-KA20FA	20/25	2.50

Tech Data
3003



Zwenktapbevestiging voor 'TC'

0334	mm	€
F-KA8TC	8/10	4.65
F-KA12TC	12/16	5.75
F-KA20TC	20/25	6.45
F-KA32TC	32	8.40
F-KA40TC	40	12.90

ISO 6432 bevestigingen

Tech Data
3004



Scharnierbevestiging achter 'SDB'

0334	Ø mm	€
F-KA8SDB	8/10	3.55
F-KA12SDB	12/16	5.30
F-KA20SDB	20/25	5.75
F-KA32SDB	32	6.50
F-KA40SDB	40	7.20

Tech Data
3005



Bevestigingsvoet 'LB' (paar)

0334	Ø mm	€
F-KA8LB	8/10	3.60
F-KA12LB	12/16	5.25
F-KA20LB	20/25	6.50
F-KA32LB	32	7.70
F-KA40LB	40	9.75

Tech Data
3006



Zuigerstang gaffel 'Y'

0334	Ø mm	€	
F-M04070YE	8/10	M4 x 0,7	4.65
F-M06100YE	12/16	M6 x 1	6.50
F-M08125YE	20	M8 x 1,25	6.80
F-M1025YE	25/32	M10 x 1,25	8.60

Tech Data
3007



Zuigerstang gaffel 'I'

0334	Ø mm	€	
F-M06100II	12/16	M6 x 1	4.65
F-M08125II	20	M8 x 1,25	5.10
F-M10125II	25/32	M10 x 1,25	6.30
F-M12125II	40	M12 x 1,25	8.35

Tech Data
3008



Uitlijnkop 'F'

0334	Ø mm	€	
F-M08125F	20	M8 x 1,25	16.60
F-M10125F	25/32	M10 x 1,25	18.75
F-M12125F	40	M12 x 1,25	20.30

Tech Data
3009

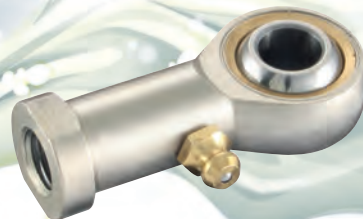

Universele kogelstangkop 'U'

0334	Ø mm	€	
F-M04070U	8/10	M4 x 0,7	7.75
F-M06100U	12/16	M6 x 1	7.95
F-M08125U	20	M8 x 1,25	8.05
F-M10125U	25/32	M10 x 1,25	9.85
F-M12125U	40	M12 x 1,25	11.55

ISO 6432 magneetschakelaars

Tech Data
3010



Tweepolig - NO met LED

0334	Ø mm	€	
CS1-M-8	8	5-240V AC/DC	21.05
CS1-M-10	10	5-240V AC/DC	21.05
CS1-M-12	12	5-240V AC/DC	21.05
CS1-M-16	16	5-240V AC/DC	21.05
CS1-M-20	20	5-240V AC/DC	21.05
CS1-M-25	25	5-240V AC/DC	21.05
CS1-M-32	32	5-240V AC/DC	21.05
CS1-M-40	40	5-240V AC/DC	21.05

ISO 6432 RVS persluchtcilinder

Accessoires en bevestiging selectie



Cilinders
op pagina 526
Bevestigingen
op pagina 527
Magneetschakelaars
op pagina 527

Dubbelwerkende

ISO 6432 RVS rondcilinders

FA - Flensbevestiging voor
SDB - Scharnierbevestiging achter
LB - Bevestigingsvoet
Y - Zuigerstang gaffel
Moer
Moer voor zuigerstang
Magneetschakelaars
Montagebeugel voor
magneetschakelaar

ISO 6432 RVS persluchtcilinder Technische informatie

Binnenstructuur

- 1 RVS AISI-304 moer
- 2 RVS AISI-316 zuigerstang
- 3 Polyurethaan O-ring zuiger
- 4 RVS AISI-304 kap voorzijde
- 5 RVS AISI-304 moer
- 6 Sinterbrons geleider
- 7 NBR O-ring
- 8 Neopreen buffer
- 9 Messing zuiger
- 10 Polyurethaan O-ring
- 11 Plastroferriet magneet
- 12 RVS AISI-304 cilinderbuis
- 13 RVS AISI-304 kap achterzijde

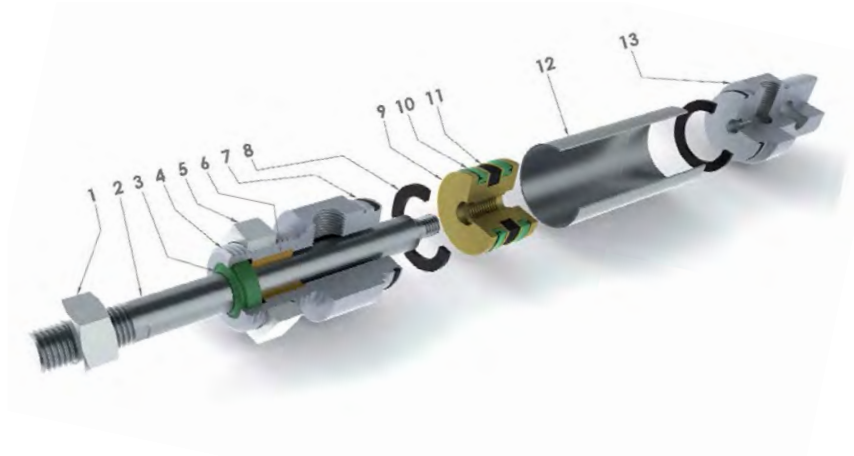

Afmetingen

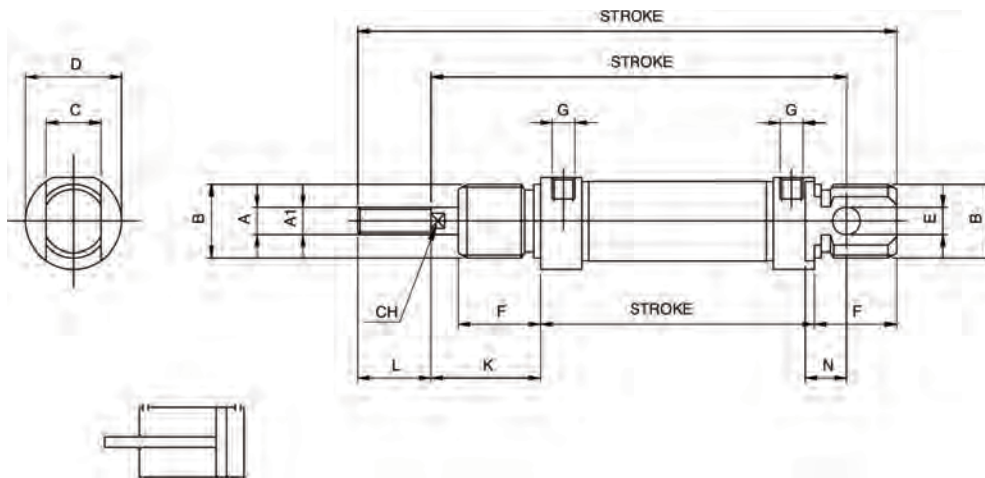

KASS

Ø mm.	A	A'	B	C	D	E	F	G	K	L	M	N	P	R	CH
16	M6	6	M16x1.5	12	19	6	18	M5	22	16	109	9	53	82	5
20	M8	8	M22x1.5	16	27	8	20	1/8"	24	20	131	12	67	95	7
25	M10x1.25	10	M22x1.5	16	30	8	22	1/8"	26	22	140	12	68	104	7

Persluchtcilinders

ISO 6432 RVS rondcilinders



Volledig roestvaststalen rondcilinders.

Tech Data
10287

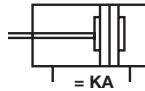

Medium:

Geconditioneerde perslucht, gefilterd (40µm) en gesmeerd.
Geschikt voor alle industriële gebieden, maar bijzonder geschikt voor gebruik in corrosieve omgevingen.

Volledige technische specificaties worden op aanvraag verstrekt

Magnetisch - dubbelwerkend

	0333	mm	mm		Locknut	Rod Thread	€
Hydrauliek	KASS-16X10-S-CA	16	10	M5	M16 x 1.5	M6	113.05
	KASS-16X25-S-CA	16	25	M5	M16 x 1.5	M6	113.05
	KASS-16X50-S-CA	16	50	M5	M16 x 1.5	M6	114.30
Snel-koppelingen	KASS-16X80-S-CA	16	80	M5	M16 x 1.5	M6	115.75
	KASS-16X100-S-CA	16	100	M5	M16 x 1.5	M6	116.85
	KASS-16X125-S-CA	16	125	M5	M16 x 1.5	M6	118.00
Afsluiters	KASS-16X160-S-CA	16	160	M5	M16 x 1.5	M6	120.50
	KASS-16X200-S-CA	16	200	M5	M16 x 1.5	M6	122.50
	KASS-16X250-S-CA	16	250	M5	M16 x 1.5	M6	124.95
Roestvast staal	KASS-16X320-S-CA	16	320	M5	M16 x 1.5	M6	128.50
	KASS-20X10-S-CA	20	10	1/8"	M22 x 1.5	M8	129.05
	KASS-20X25-S-CA	20	25	1/8"	M22 x 1.5	M8	128.85
Fittingen	KASS-20X50-S-CA	20	50	1/8"	M22 x 1.5	M8	130.30
	KASS-20X80-S-CA	20	80	1/8"	M22 x 1.5	M8	131.95
	KASS-20X100-S-CA	20	100	1/8"	M22 x 1.5	M8	134.15
Lucht-conditionering	KASS-20X125-S-CA	20	125	1/8"	M22 x 1.5	M8	135.50
	KASS-20X160-S-CA	20	160	1/8"	M22 x 1.5	M8	138.45
	KASS-20X200-S-CA	20	200	1/8"	M22 x 1.5	M8	140.80
Pneumatiek	KASS-20X250-S-CA	20	250	1/8"	M22 x 1.5	M8	143.60
	KASS-20X320-S-CA	20	320	1/8"	M22 x 1.5	M8	147.60
	KASS-25X10-S-CA	25	10	1/8"	M22 x 1.5	M10 x 1.25	135.70
Diversen	KASS-25X25-S-CA	25	25	1/8"	M22 x 1.5	M10 x 1.25	136.95
	KASS-25X50-S-CA	25	50	1/8"	M22 x 1.5	M10 x 1.25	139.05
	KASS-25X80-S-CA	25	80	1/8"	M22 x 1.5	M10 x 1.25	141.55
Malleerbare fittingen & staal	KASS-25X100-S-CA	25	100	1/8"	M22 x 1.5	M10 x 1.25	143.15
	KASS-25X125-S-CA	25	125	1/8"	M22 x 1.5	M10 x 1.25	145.15
	KASS-25X160-S-CA	25	160	1/8"	M22 x 1.5	M10 x 1.25	149.15
Ringleiding-systemen	KASS-25X200-S-CA	25	200	1/8"	M22 x 1.5	M10 x 1.25	152.45
	KASS-25X250-S-CA	25	250	1/8"	M22 x 1.5	M10 x 1.25	156.55
	KASS-25X320-S-CA	25	320	1/8"	M22 x 1.5	M10 x 1.25	167.60

ISO 6432 RVS bevestigingen



Flensbevestiging voor 'FA'

0333



F-KASS16FA	16	12.10
F-KASS20FA	20/25	20.40



Bevestigingsvoet 'LB' (enkel)

0333



F-KASS16LB	16	13.00
F-KASS20LB	20/25	23.10



Scharnierbevestiging achter 'SDB'

0333



F-KASS16SDB	16	21.35
F-KASS20SDB	20/25	29.25



Zuigerstang gaffel 'Y'

0333



F-KASS16Y	16	M6 x 1	7.05
F-KASS20Y	20	M8 x 1.25	8.55
F-KASS25Y	25	M10 x 1.25	11.45

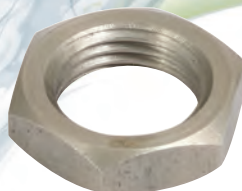

Moer

0333



F-KASS16LN	16	M16 x 1.5	4.30
F-KASS20LN	20/25	M22 x 1.5	5.55



Moer voor zuigerstang

0333



F-KASS16PLN	16	M6	1.45
F-KASS20PLN	20	M8	1.60
F-KASS25PLN	25	M10 x 1.25	1.85

ISO 6432 magneetschakelaars



Tweepolig - NO met LED

0333



KRS-2.5	5-240V AC/DC	31.55
----------------	--------------	--------------



Montagebeugel voor magneetschakelaar

0333



RSMC16	16	7.90
RSMC20	20	7.75
RSMC25	25	7.60

KELM™
pneumatiek

Hydrauliek

Snel-
koppelingen

Afsluiters

Roestvast
staal

Fittingen

Lucht-
conditionering

Gereedschap

Pneumatiek

Diversen

Malleabele
fittingen
& staal

Ringleiding-
systemen

Slangen

Compressoren

Gen 2 ISO 15552 persluchtcilinder

Accessoires en bevestiging selectie

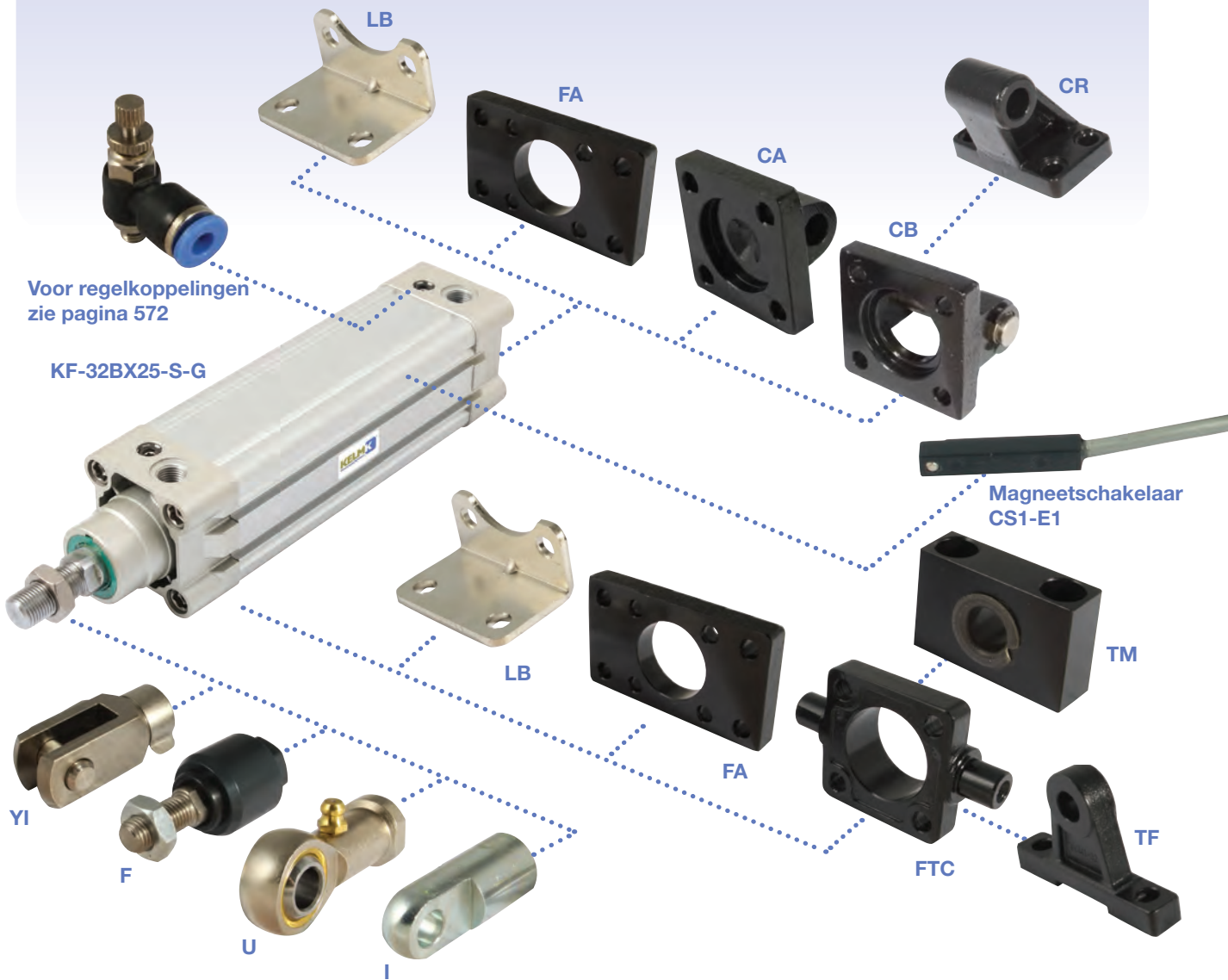

Voor regelkoppelingen
zie pagina 572

KF-32BX25-S-G

Magneetschakelaar
CS1-E1

Cilinders

op pagina 530-531

Bevestigingen

op pagina 536-537

Magneetschakelaars

op pagina 538



Gen 2 ISO 15552 cilinders

FA - Flensbevestiging voor/
achter

FTC - Zwenktapbevestiging voor

TF - Zwenktap/
gaffelbevestiging voor

TM - Zwenktapsteun

CA - Enkel achterscharnier

CB - Dubbel achterscharnier

CR - Bevestigingssteun achter

LB - Bevestigingsvoet (paar)

YI - Zuigerstang gaffel

I - Zuigerstang gaffel

F - Uitlijnkop

U - Universele kogelstangkop

Tweepolige magneetschakelaars
N/O met LED

Gen 2 ISO 15552 persluchtcilinder

Technische informatie

Binnenstructuur

Nr.	Onderdeel	Materiaal
1	Zuigerstangmoer	Koolstofstaal of RVS
2	Zuigerstang	Koolstofstaal of RVS
3	Pakking kap voorzijde	TPU
4	Kap voorzijde	Aluminiumlegering
5	Geleider	Slijtvast materiaal
6	O-ring buffer	TPU
7	Buis	Aluminiumlegering
8	O-ring	NBR
9	Zuiger	Aluminiumlegering
10	O-ring zuiger	TPU
11	Slijtring	Slijtvast materiaal
12	Magneet	Kunststof of rubber (rubber vanaf ø125)
13	Bout	Koolstofstaal
14	Buffer pakking	TPU
15	Kap achterzijde	Aluminiumlegering
16	Schroef	Koolstofstaal of RVS

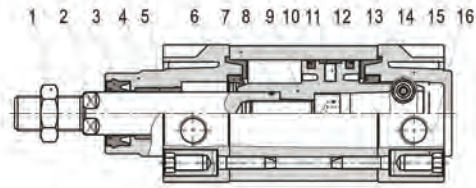

Afmetingen

Boring	A	B	C	D	E	F	G	H	I	J	K
32	142	48	94	30	29	19	27.5	22	17	6	M10×1.25
40	159	54	105	35	33	21	32	24	17	7	M12×1.25
50	175	69	106	40	42	27	31	32	23	8	M16×1.5
63	190	69	121	45	42	27	33	32	23	8	M16×1.5
80	214	86	128	45	53	33	33	40	26	10	M20×1.5
100	229	91	138	55	55	36	37	40	26	10	M20×1.5
125	279	119	160	60	74	45	46	54	41	13.5	M27×2

Boring	L	N	O	P	Q	R	S	T	V	W	X	Z
32	M6	13.5	1/8"	5.8	6	6.3	46.5	32.5	12	10	3	30
40	M6	17.5	1/4"	6	5.5	9	54	38	16	13	3.5	35
50	M8	14	1/4"	8	5	10.5	64	46.5	20	17	3.5	40
63	M8	17	3/8"	8	6	10.5	75	56.5	20	17	4	45
80	M10	16.5	3/8"	8	8.5	12.5	93	72	25	22	4	45
100	M10	19.5	1/2"	10	7	12	110	89	25	22	4	55
125	M12	23	1/2"	11	12	11	134	110	32	27	4	60

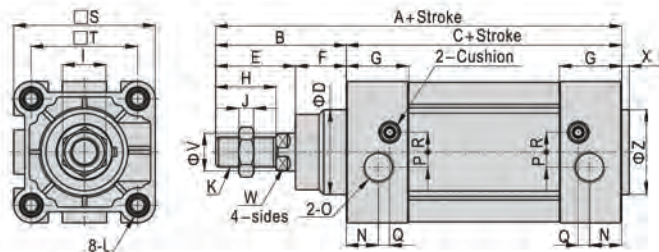

Gen 2 ISO 15552 cilinders



Temperatuur:
-20°C tot +80°C

Maximale werkdruk:
1 tot 10 bar



Medium:

Geconditioneerde perslucht, gefilterd (40µm) en gesmeerd.
Met instelbare buffering
Volledige technische specificaties worden op aanvraag verstrekt

Tech Data
10657

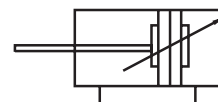

Magnetisch - dubbelwerkend - instelbare buffering

	0413	Ø mm	mm		Rod Thread	€	0413	Ø mm	mm		Rod Thread	€
KELM™ pneumatiek	KI-32BX25-S-G	32	25	1/8"	M10 x 1.25	66.55	KI-40BX150-S-G	40	150	1/4"	M12 x 1.25	88.25
	KI-32BX50-S-G	32	50	1/8"	M10 x 1.25	69.45	KI-40BX160-S-G	40	160	1/4"	M12 x 1.25	91.00
Hydrauliek	KI-32BX75-S-G	32	75	1/8"	M10 x 1.25	72.45	KI-40BX175-S-G	40	175	1/4"	M12 x 1.25	91.00
	KI-32BX80-S-G	32	80	1/8"	M10 x 1.25	74.10	KI-40BX200-S-G	40	200	1/4"	M12 x 1.25	93.70
	KI-32BX100-S-G	32	100	1/8"	M10 x 1.25	74.10	KI-40BX250-S-G	40	250	1/4"	M12 x 1.25	99.80
Snelkoppelingen	KI-32BX125-S-G	32	125	1/8"	M10 x 1.25	76.85	KI-40BX300-S-G	40	300	1/4"	M12 x 1.25	105.90
	KI-32BX150-S-G	32	150	1/8"	M10 x 1.25	79.80	KI-40BX350-S-G	40	350	1/4"	M12 x 1.25	112.20
	KI-32BX160-S-G	32	160	1/8"	M10 x 1.25	82.50	KI-40BX400-S-G	40	400	1/4"	M12 x 1.25	118.35
Afsluiters	KI-32BX175-S-G	32	175	1/8"	M10 x 1.25	82.50	KI-40BX450-S-G	40	450	1/4"	M12 x 1.25	124.45
	KI-32BX200-S-G	32	200	1/8"	M10 x 1.25	85.10	KI-40BX500-S-G	40	500	1/4"	M12 x 1.25	130.75
Roestvast staal	KI-32BX250-S-G	32	250	1/8"	M10 x 1.25	90.35	KI-40BX600-S-G	40	600	1/4"	M12 x 1.25	143.40
	KI-32BX300-S-G	32	300	1/8"	M10 x 1.25	95.60	KI-40BX700-S-G	40	700	1/4"	M12 x 1.25	156.05
Fittingen	KI-32BX350-S-G	32	350	1/8"	M10 x 1.25	100.65	KI-40BX800-S-G	40	800	1/4"	M12 x 1.25	169.10
	KI-32BX400-S-G	32	400	1/8"	M10 x 1.25	105.90	KI-50BX25-S-G	50	25	1/4"	M16 x 1.5	91.15
	KI-32BX450-S-G	32	450	1/8"	M10 x 1.25	111.20	KI-50BX50-S-G	50	50	1/4"	M16 x 1.5	94.15
	KI-32BX500-S-G	32	500	1/8"	M10 x 1.25	116.45	KI-50BX75-S-G	50	75	1/4"	M16 x 1.5	97.05
Luchtconditionering	KI-40BX25-S-G	40	25	1/4"	M12 x 1.25	74.10	KI-50BX80-S-G	50	80	1/4"	M16 x 1.5	99.80
	KI-40BX50-S-G	40	50	1/4"	M12 x 1.25	76.85	KI-50BX100-S-G	50	100	1/4"	M16 x 1.5	99.80
Gereedschap	KI-40BX75-S-G	40	75	1/4"	M12 x 1.25	79.80	KI-50BX125-S-G	50	125	1/4"	M16 x 1.5	104.20
	KI-40BX80-S-G	40	80	1/4"	M12 x 1.25	82.50	KI-50BX150-S-G	50	150	1/4"	M16 x 1.5	108.45
	KI-40BX100-S-G	40	100	1/4"	M12 x 1.25	82.50	KI-50BX160-S-G	50	160	1/4"	M16 x 1.5	112.65
Pneumatiek	KI-40BX125-S-G	40	125	1/4"	M12 x 1.25	85.50	KI-50BX175-S-G	50	175	1/4"	M16 x 1.5	112.65

Raadpleeg de volgende pagina voor andere maten in deze reeks

Gen 2 ISO 15552 cilinders

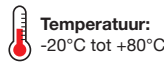

Medium:

Geconditioneerde perslucht, gefilterd (40µm) en gesmeerd.

Met instelbare buffering

Volledige technische specificaties worden op aanvraag verstrekt

Tech Data
10657



Magnetisch - dubbelwerkend - instelbare buffering

0413	Ø mm	Stroke mm	Stroke inch	Rod Thread	€	0413	Ø mm	Stroke mm	Stroke inch	Rod Thread	€
KI-50BX200-S-G	50	200	1/4"	M16 x 1.5	116.85	KI-80BX500-S-G	80	500	3/8"	M20 x 1.5	275.05
KI-50BX250-S-G	50	250	1/4"	M16 x 1.5	124.25	KI-80BX600-S-G	80	600	3/8"	M20 x 1.5	302.60
KI-50BX300-S-G	50	300	1/4"	M16 x 1.5	131.60	KI-80BX700-S-G	80	700	3/8"	M20 x 1.5	330.85
KI-50BX350-S-G	50	350	1/4"	M16 x 1.5	139.40	KI-80BX800-S-G	80	800	3/8"	M20 x 1.5	358.85
KI-50BX400-S-G	50	400	1/4"	M16 x 1.5	147.20	KI-80BX900-S-G	80	900	3/8"	M20 x 1.5	387.50
KI-50BX450-S-G	50	450	1/4"	M16 x 1.5	154.95	KI-80BX1000-S-G	80	1000	3/8"	M20 x 1.5	415.95
KI-50BX500-S-G	50	500	1/4"	M16 x 1.5	162.80	KI-100BX25-S-G	100	25	1/2"	M20 x 1.5	187.00
KI-50BX600-S-G	50	600	1/4"	M16 x 1.5	178.60	KI-100BX50-S-G	100	50	1/2"	M20 x 1.5	195.85
KI-50BX700-S-G	50	700	1/4"	M16 x 1.5	194.55	KI-100BX75-S-G	100	75	1/2"	M20 x 1.5	203.45
KI-50BX800-S-G	50	800	1/4"	M16 x 1.5	210.35	KI-100BX80-S-G	100	80	1/2"	M20 x 1.5	210.80
KI-50BX900-S-G	50	900	1/4"	M16 x 1.5	226.80	KI-100BX100-S-G	100	100	1/2"	M20 x 1.5	210.80
KI-50BX1000-S-G	50	1000	1/4"	M16 x 1.5	243.20	KI-100BX125-S-G	100	125	1/2"	M20 x 1.5	218.80
KI-63BX25-S-G	63	25	3/8"	M16 x 1.5	112.45	KI-100BX150-S-G	100	150	1/2"	M20 x 1.5	226.80
KI-63BX50-S-G	63	50	3/8"	M16 x 1.5	117.10	KI-100BX160-S-G	100	160	1/2"	M20 x 1.5	234.60
KI-63BX75-S-G	63	75	3/8"	M16 x 1.5	121.50	KI-100BX175-S-G	100	175	1/2"	M20 x 1.5	234.60
KI-63BX80-S-G	63	80	3/8"	M16 x 1.5	127.60	KI-100BX200-S-G	100	200	1/2"	M20 x 1.5	242.40
KI-63BX100-S-G	63	100	3/8"	M16 x 1.5	127.60	KI-100BX250-S-G	100	250	1/2"	M20 x 1.5	258.00
KI-63BX125-S-G	63	125	3/8"	M16 x 1.5	131.60	KI-100BX300-S-G	100	300	1/2"	M20 x 1.5	273.75
KI-63BX150-S-G	63	150	3/8"	M16 x 1.5	135.40	KI-100BX350-S-G	100	350	1/2"	M20 x 1.5	289.55
KI-63BX160-S-G	63	160	3/8"	M16 x 1.5	139.80	KI-100BX400-S-G	100	400	1/2"	M20 x 1.5	305.35
KI-63BX175-S-G	63	175	3/8"	M16 x 1.5	139.80	KI-100BX450-S-G	100	450	1/2"	M20 x 1.5	321.40
KI-63BX200-S-G	63	200	3/8"	M16 x 1.5	144.25	KI-100BX500-S-G	100	500	1/2"	M20 x 1.5	337.35
KI-63BX250-S-G	63	250	3/8"	M16 x 1.5	153.55	KI-100BX600-S-G	100	600	1/2"	M20 x 1.5	369.60
KI-63BX300-S-G	63	300	3/8"	M16 x 1.5	162.60	KI-100BX700-S-G	100	700	1/2"	M20 x 1.5	401.80
KI-63BX350-S-G	63	350	3/8"	M16 x 1.5	172.05	KI-100BX800-S-G	100	800	1/2"	M20 x 1.5	434.65
KI-63BX400-S-G	63	400	3/8"	M16 x 1.5	181.30	KI-100BX900-S-G	100	900	1/2"	M20 x 1.5	467.30
KI-63BX450-S-G	63	450	3/8"	M16 x 1.5	190.80	KI-100BX1000-S-G	100	1000	1/2"	M20 x 1.5	500.55
KI-63BX500-S-G	63	500	3/8"	M16 x 1.5	200.45	KI-125BX25-S-G	125	25	1/2"	M27 x 2	295.05
KI-63BX600-S-G	63	600	3/8"	M16 x 1.5	220.05	KI-125BX50-S-G	125	50	1/2"	M27 x 2	304.10
KI-63BX700-S-G	63	700	3/8"	M16 x 1.5	239.65	KI-125BX75-S-G	125	75	1/2"	M27 x 2	312.75
KI-63BX800-S-G	63	800	3/8"	M16 x 1.5	259.45	KI-125BX80-S-G	125	80	1/2"	M27 x 2	321.80
KI-63BX900-S-G	63	900	3/8"	M16 x 1.5	279.45	KI-125BX100-S-G	125	100	1/2"	M27 x 2	321.80
KI-63BX1000-S-G	63	1000	3/8"	M16 x 1.5	299.70	KI-125BX125-S-G	125	125	1/2"	M27 x 2	335.05
KI-80BX25-S-G	80	25	3/8"	M20 x 1.5	149.70	KI-125BX150-S-G	125	150	1/2"	M27 x 2	348.10
KI-80BX50-S-G	80	50	3/8"	M20 x 1.5	155.85	KI-125BX160-S-G	125	160	1/2"	M27 x 2	360.75
KI-80BX75-S-G	80	75	3/8"	M20 x 1.5	161.70	KI-125BX175-S-G	125	175	1/2"	M27 x 2	360.75
KI-80BX80-S-G	80	80	3/8"	M20 x 1.5	167.60	KI-125BX200-S-G	125	200	1/2"	M27 x 2	373.40
KI-80BX100-S-G	80	100	3/8"	M20 x 1.5	167.60	KI-125BX250-S-G	125	250	1/2"	M27 x 2	399.30
KI-80BX125-S-G	80	125	3/8"	M20 x 1.5	174.15	KI-125BX300-S-G	125	300	1/2"	M27 x 2	424.95
KI-80BX150-S-G	80	150	3/8"	M20 x 1.5	180.90	KI-125BX350-S-G	125	350	1/2"	M27 x 2	451.05
KI-80BX160-S-G	80	160	3/8"	M20 x 1.5	187.40	KI-125BX400-S-G	125	400	1/2"	M27 x 2	477.20
KI-80BX175-S-G	80	175	3/8"	M20 x 1.5	187.40	KI-125BX450-S-G	125	450	1/2"	M27 x 2	503.30
KI-80BX200-S-G	80	200	3/8"	M20 x 1.5	194.15	KI-125BX500-S-G	125	500	1/2"	M27 x 2	529.25
KI-80BX250-S-G	80	250	3/8"	M20 x 1.5	207.45	KI-125BX600-S-G	125	600	1/2"	M27 x 2	581.65
KI-80BX300-S-G	80	300	3/8"	M20 x 1.5	220.90	KI-125BX700-S-G	125	700	1/2"	M27 x 2	634.10
KI-80BX350-S-G	80	350	3/8"	M20 x 1.5	234.40	KI-125BX800-S-G	125	800	1/2"	M27 x 2	686.95
KI-80BX400-S-G	80	400	3/8"	M20 x 1.5	247.85	KI-125BX900-S-G	125	900	1/2"	M27 x 2	740.45
KI-80BX450-S-G	80	450	3/8"	M20 x 1.5	261.55	KI-125BX1000-S-G	125	1000	1/2"	M27 x 2	794.15

ISO 15552 persluchtcilinder

Accessoires en bevestiging selectie

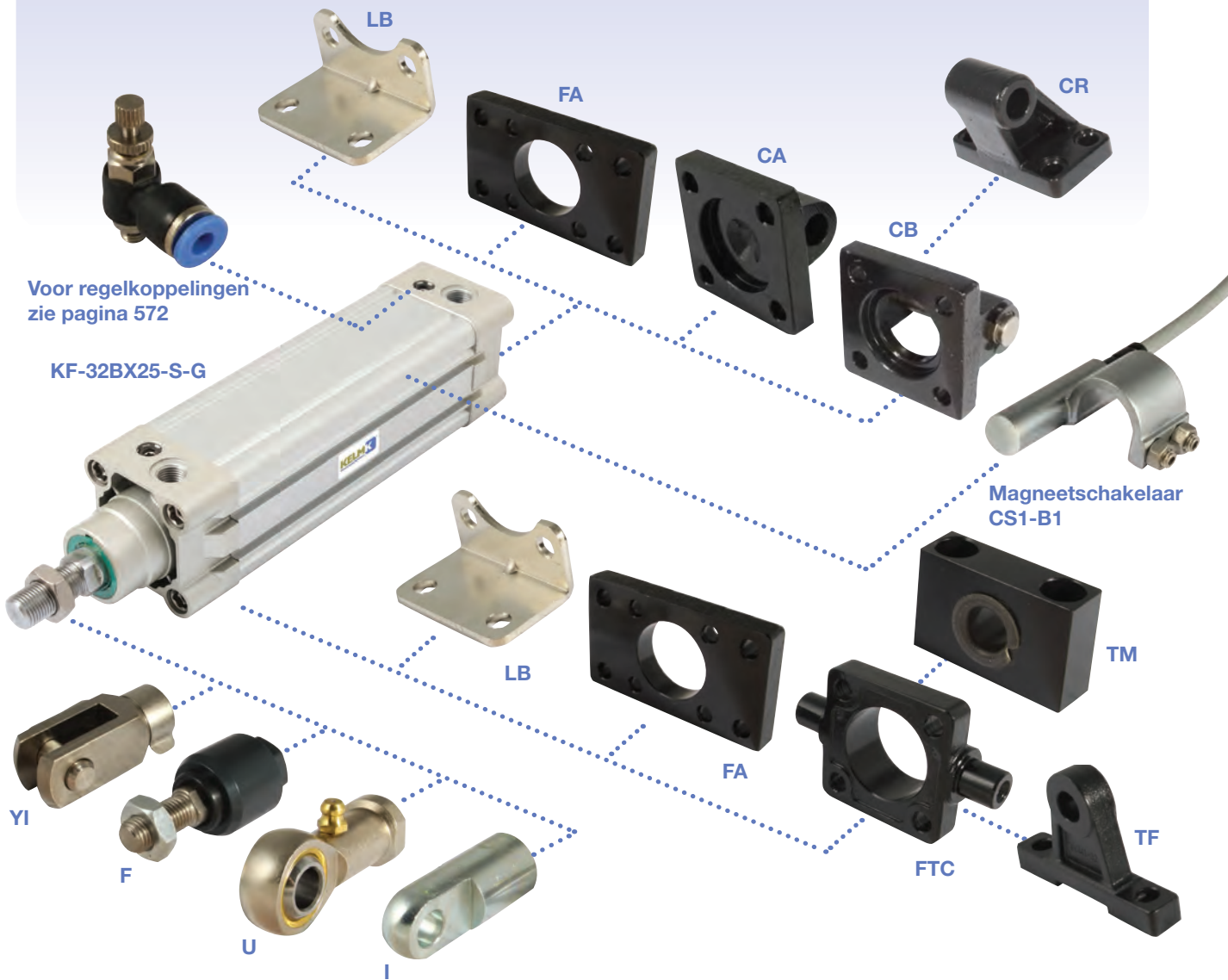

Voor regelkoppelingen
zie pagina 572

KF-32BX25-S-G

Magneetschakelaar
CS1-B1

Cilinders

op pagina 534-535

Bevestigingen

op pagina 536-537

Magneetschakelaars

op pagina 538

ISO 15552 cilinders

FA - Flensbevestiging voor/
achter
FTC - Zwenktapbevestiging voor
TF - Zwenktap/
gaffelbevestiging voor
TM - Zwenktapsteun
CA - Enkel achterscharnier
CB - Dubbel achterscharnier
CR - Bevestigingssteun achter

LB - Bevestigingsvoet (paar)
YI - Zuigerstang gaffel
I - Zuigerstang gaffel
F - Uitlijnkop
U - Universele kogelstangkop

Tweepolige magneetschakelaars
N/O met LED
Driepolige magneetschakelaars
N/O met NPN of PNP stroming



ISO 15552 persluchtcilinder

Technische informatie

KF serie

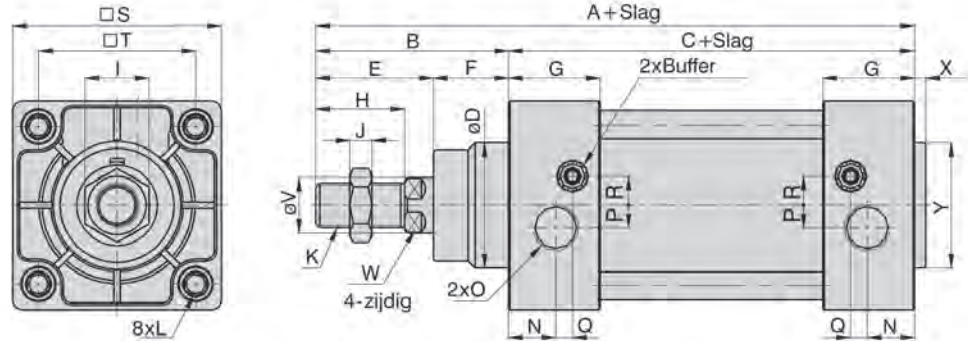

Boring	A	B	C	D	E	F	G	H	I	J	K	L	N	O	P	Q	R	S	T	V	W	X	Y
32	142	48	94	30	29	19	27.5	22	17	6	M10 x 1.25	M8	13	1/8"	5.5	6	6	47	32.5	12	10	3	30
40	159	54	105	35	33	21	32	24	17	7	M12 x 1.25	M6	17	1/4"	6	7.5	8.5	53	38	16	13	3.5	35
50	175	69	106	40	42	27	31	32	23	8	M16 x 1.5	M8	15.5	1/4"	7.5	8.5	9.5	65	46.5	20	17	3.5	40
63	190	69	121	45	42	27	33	32	23	8	M16 x 1.5	M8	16.5	3/8"	7.5	7.5	11.5	75	56.5	20	17	4	45
80	214	86	128	45	53	33	33	40	26	10	M20 x 1.5	M10	16.5	3/8"	9	7.5	13.5	95	72	25	22	4	45
100	229	91	138	55	55	36	37	40	26	10	M20 x 1.5	M10	18.5	1/2"	9.5	8.5	13.5	115	89	25	22	4	55
125	279	119	160	60	74	45	46	54	41	13.5	M27 x 2	M12	23	1/2"	14	12	14	140	110	32	27	4	60
160	332	152	180	65	94	58	50	72	55	18	M36 x 2	M16	25	3/4"	15	12	20	180	140	40	36	4	65
200	347	167	180	75	100	67	50	72	55	18	M36 x 2	M16	25	3/4"	15	12	20	220	175	40	36	5	75

Binnenstructuur

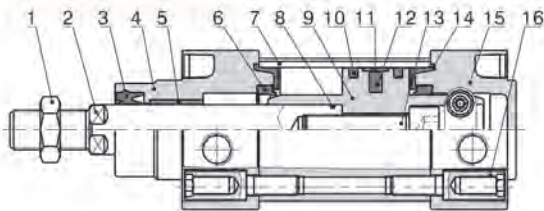

Nr.	Onderdeel	Materiaal	Nr.	Onderdeel	Materiaal
1	Zuigerstangmoer	Koolstofstaal	9	Zuiger	Aluminiumlegering
2	Zuigerstang	Roestvast staal	10	O-ring zuiger	TPU
3	Pakking kap voorzijde	TPU	11	Slijtring	Slijtvast materiaal
4	Kap voorzijde	Aluminiumlegering	12	Magneet	Boring < ø100: Plastic Overige: Rubber
5	Geleider	Slijtvast materiaal	13	Bout	Koolstofstaal
6	O-ring buffer	TPU	14	Buffer pakking	TPU
7	Buis	Aluminiumlegering	15	Kap achterzijde	Aluminiumlegering
8	O-ring stang	NBR	16	Moer trekstang	Koolstofstaal

Perslucht cilinders



ISO 15552 cilinders

Werktemperatuur:
-20°C tot +80°C



Werkdruk:
1 tot 10 bar

Medium:

Geconditioneerde perslucht, gefilterd (40µm) en gesmeerd.

Met instelbare buffering

Volledige technische specificaties worden op aanvraag verstrekt

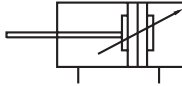

**Tech Data
3011**

Magnetisch - dubbelwerkend - instelbare buffering

	0334	Ø mm	Stroke mm	BSPB	Rod Thread	€	0334	Ø mm	Stroke mm	BSPB	Rod Thread	€
	KF-32BX25-S-G	32	25	1/8"	M10 x 1,25	63.35	KF-50BX400-S-G	50	400	1/4"	M16 x 1,5	164.80
	KF-32BX50-S-G	32	50	1/8"	M10 x 1,25	65.40	KF-50BX450-S-G	50	450	1/4"	M16 x 1,5	173.75
	KF-32BX75-S-G	32	75	1/8"	M10 x 1,25	66.75	KF-50BX500-S-G	50	500	1/4"	M16 x 1,5	178.60
	KF-32BX80-S-G	32	80	1/8"	M10 x 1,25	68.05	KF-50BX600-S-G	50	600	1/4"	M16 x 1,5	197.25
	KF-32BX100-S-G	32	100	1/8"	M10 x 1,25	69.40	KF-50BX700-S-G	50	700	1/4"	M16 x 1,5	216.50
	KF-32BX125-S-G	32	125	1/8"	M10 x 1,25	73.15	KF-50BX800-S-G	50	800	1/4"	M16 x 1,5	235.50
	KF-32BX150-S-G	32	150	1/8"	M10 x 1,25	75.10	KF-50BX900-S-G	50	900	1/4"	M16 x 1,5	254.50
	KF-32BX160-S-G	32	160	1/8"	M10 x 1,25	75.95	KF-50BX1000-S-G	50	1000	1/4"	M16 x 1,5	273.40
	KF-32BX175-S-G	32	175	1/8"	M10 x 1,25	77.45	KF-63BX25-S-G	63	25	3/8"	M16 x 1,5	110.60
	KF-32BX200-S-G	32	200	1/8"	M10 x 1,25	80.30	KF-63BX50-S-G	63	50	3/8"	M16 x 1,5	113.65
	KF-32BX250-S-G	32	250	1/8"	M10 x 1,25	86.10	KF-63BX75-S-G	63	75	3/8"	M16 x 1,5	120.10
	KF-32BX300-S-G	32	300	1/8"	M10 x 1,25	89.60	KF-63BX80-S-G	63	80	3/8"	M16 x 1,5	123.20
	KF-32BX350-S-G	32	350	1/8"	M10 x 1,25	94.70	KF-63BX100-S-G	63	100	3/8"	M16 x 1,5	124.30
	KF-32BX400-S-G	32	400	1/8"	M10 x 1,25	101.85	KF-63BX125-S-G	63	125	3/8"	M16 x 1,5	132.85
	KF-32BX450-S-G	32	450	1/8"	M10 x 1,25	103.60	KF-63BX150-S-G	63	150	3/8"	M16 x 1,5	137.80
	KF-32BX500-S-G	32	500	1/8"	M10 x 1,25	111.35	KF-63BX160-S-G	63	160	3/8"	M16 x 1,5	139.40
	KF-40BX25-S-G	40	25	1/4"	M12 x 1,25	69.90	KF-63BX175-S-G	63	175	3/8"	M16 x 1,5	142.80
	KF-40BX50-S-G	40	50	1/4"	M12 x 1,25	74.65	KF-63BX200-S-G	63	200	3/8"	M16 x 1,5	148.75
	KF-40BX75-S-G	40	75	1/4"	M12 x 1,25	76.50	KF-63BX250-S-G	63	250	3/8"	M16 x 1,5	157.30
	KF-40BX80-S-G	40	80	1/4"	M12 x 1,25	80.50	KF-63BX300-S-G	63	300	3/8"	M16 x 1,5	163.30
	KF-40BX100-S-G	40	100	1/4"	M12 x 1,25	82.20	KF-63BX350-S-G	63	350	3/8"	M16 x 1,5	175.15
	KF-40BX125-S-G	40	125	1/4"	M12 x 1,25	85.05	KF-63BX400-S-G	63	400	3/8"	M16 x 1,5	180.15
	KF-40BX150-S-G	40	150	1/4"	M12 x 1,25	87.30	KF-63BX450-S-G	63	450	3/8"	M16 x 1,5	192.10
	KF-40BX160-S-G	40	160	1/4"	M12 x 1,25	91.70	KF-63BX500-S-G	63	500	3/8"	M16 x 1,5	201.75
	KF-40BX175-S-G	40	175	1/4"	M12 x 1,25	92.10	KF-63BX600-S-G	63	600	3/8"	M16 x 1,5	222.25
	KF-40BX200-S-G	40	200	1/4"	M12 x 1,25	93.05	KF-63BX700-S-G	63	700	3/8"	M16 x 1,5	242.65
	KF-40BX250-S-G	40	250	1/4"	M12 x 1,25	102.90	KF-63BX800-S-G	63	800	3/8"	M16 x 1,5	263.15
	KF-40BX300-S-G	40	300	1/4"	M12 x 1,25	108.90	KF-63BX900-S-G	63	900	3/8"	M16 x 1,5	283.60
	KF-40BX350-S-G	40	350	1/4"	M12 x 1,25	112.85	KF-63BX1000-S-G	63	1000	3/8"	M16 x 1,5	304.05
	KF-40BX400-S-G	40	400	1/4"	M12 x 1,25	122.40	KF-80BX25-S-G	80	25	3/8"	M20 x 1,5	157.25
	KF-40BX450-S-G	40	450	1/4"	M12 x 1,25	129.35	KF-80BX50-S-G	80	50	3/8"	M20 x 1,5	167.20
	KF-40BX500-S-G	40	500	1/4"	M12 x 1,25	136.30	KF-80BX75-S-G	80	75	3/8"	M20 x 1,5	170.90
	KF-40BX600-S-G	40	600	1/4"	M12 x 1,25	147.40	KF-80BX80-S-G	80	80	3/8"	M20 x 1,5	175.30
	KF-40BX700-S-G	40	700	1/4"	M12 x 1,25	166.00	KF-80BX100-S-G	80	100	3/8"	M20 x 1,5	183.70
	KF-40BX800-S-G	40	800	1/4"	M12 x 1,25	175.95	KF-80BX125-S-G	80	125	3/8"	M20 x 1,5	183.95
	KF-50BX25-S-G	50	25	1/4"	M16 x 1,5	96.25	KF-80BX150-S-G	80	150	3/8"	M20 x 1,5	195.50
	KF-50BX50-S-G	50	50	1/4"	M16 x 1,5	98.75	KF-80BX160-S-G	80	160	3/8"	M20 x 1,5	206.00
	KF-50BX75-S-G	50	75	1/4"	M16 x 1,5	104.60	KF-80BX175-S-G	80	175	3/8"	M20 x 1,5	206.25
	KF-50BX80-S-G	50	80	1/4"	M16 x 1,5	110.70	KF-80BX200-S-G	80	200	3/8"	M20 x 1,5	207.65
	KF-50BX100-S-G	50	100	1/4"	M16 x 1,5	111.35	KF-80BX250-S-G	80	250	3/8"	M20 x 1,5	228.40
	KF-50BX125-S-G	50	125	1/4"	M16 x 1,5	112.15	KF-80BX300-S-G	80	300	3/8"	M20 x 1,5	244.20
	KF-50BX150-S-G	50	150	1/4"	M16 x 1,5	118.00	KF-80BX350-S-G	80	350	3/8"	M20 x 1,5	259.55
	KF-50BX160-S-G	50	160	1/4"	M16 x 1,5	124.00	KF-80BX400-S-G	80	400	3/8"	M20 x 1,5	267.70
	KF-50BX175-S-G	50	175	1/4"	M16 x 1,5	124.30	KF-80BX450-S-G	80	450	3/8"	M20 x 1,5	291.85
	KF-50BX200-S-G	50	200	1/4"	M16 x 1,5	128.75	KF-80BX500-S-G	80	500	3/8"	M20 x 1,5	304.70
	KF-50BX250-S-G	50	250	1/4"	M16 x 1,5	137.90	KF-80BX600-S-G	80	600	3/8"	M20 x 1,5	328.65
	KF-50BX300-S-G	50	300	1/4"	M16 x 1,5	146.60	KF-80BX700-S-G	80	700	3/8"	M20 x 1,5	369.90
	KF-50BX350-S-G	50	350	1/4"	M16 x 1,5	151.90	KF-80BX800-S-G	80	800	3/8"	M20 x 1,5	391.40

ISO 15552 cilinders

Werktemperatuur:
-20°C tot +80°C

Werkdruk:
1 tot 10 bar

Medium:

Geconditioneerde perslucht, gefilterd (40µm) en gesmeerd.

Met instelbare buffering

Volledige technische specificaties worden op aanvraag verstrekt

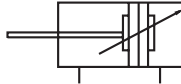

**Tech Data
3011**

Magnetisch - dubbelwerkend - instelbare buffering

0334	Ø mm	Stroke mm	BSPB	Rod Thread	€
KF-80BX900-S-G	80	900	3/8"	M20 x 1,5	422.70
KF-80BX1000-S-G	80	1000	3/8"	M20 x 1,5	453.85
KF-100BX25-S-G	100	25	1/2"	M20 x 1,5	190.90
KF-100BX50-S-G	100	50	1/2"	M20 x 1,5	200.00
KF-100BX75-S-G	100	75	1/2"	M20 x 1,5	210.20
KF-100BX80-S-G	100	80	1/2"	M20 x 1,5	210.70
KF-100BX100-S-G	100	100	1/2"	M20 x 1,5	215.00
KF-100BX125-S-G	100	125	1/2"	M20 x 1,5	226.75
KF-100BX150-S-G	100	150	1/2"	M20 x 1,5	236.90
KF-100BX160-S-G	100	160	1/2"	M20 x 1,5	237.00
KF-100BX175-S-G	100	175	1/2"	M20 x 1,5	246.10
KF-100BX200-S-G	100	200	1/2"	M20 x 1,5	254.05
KF-100BX250-S-G	100	250	1/2"	M20 x 1,5	272.05
KF-100BX300-S-G	100	300	1/2"	M20 x 1,5	278.70
KF-100BX350-S-G	100	350	1/2"	M20 x 1,5	306.85
KF-100BX400-S-G	100	400	1/2"	M20 x 1,5	325.70
KF-100BX450-S-G	100	450	1/2"	M20 x 1,5	334.35
KF-100BX500-S-G	100	500	1/2"	M20 x 1,5	351.75
KF-100BX600-S-G	100	600	1/2"	M20 x 1,5	387.75
KF-100BX700-S-G	100	700	1/2"	M20 x 1,5	424.00
KF-100BX800-S-G	100	800	1/2"	M20 x 1,5	459.95
KF-100BX900-S-G	100	900	1/2"	M20 x 1,5	495.95
KF-100BX1000-S-G	100	1000	1/2"	M20 x 1,5	531.90
KF-125BX25-S-G	125	25	1/2"	M27 x 2	316.45
KF-125BX50-S-G	125	50	1/2"	M27 x 2	330.70
KF-125BX75-S-G	125	75	1/2"	M27 x 2	344.90
KF-125BX80-S-G	125	80	1/2"	M27 x 2	359.40
KF-125BX100-S-G	125	100	1/2"	M27 x 2	366.80
KF-125BX125-S-G	125	125	1/2"	M27 x 2	374.75
KF-125BX150-S-G	125	150	1/2"	M27 x 2	390.45
KF-125BX160-S-G	125	160	1/2"	M27 x 2	406.10
KF-125BX175-S-G	125	175	1/2"	M27 x 2	408.90
KF-125BX200-S-G	125	200	1/2"	M27 x 2	420.30
KF-125BX250-S-G	125	250	1/2"	M27 x 2	451.55
KF-125BX300-S-G	125	300	1/2"	M27 x 2	481.40
KF-125BX350-S-G	125	350	1/2"	M27 x 2	512.55
KF-125BX400-S-G	125	400	1/2"	M27 x 2	542.50
KF-125BX450-S-G	125	450	1/2"	M27 x 2	573.55
KF-125BX500-S-G	125	500	1/2"	M27 x 2	603.40
KF-125BX600-S-G	125	600	1/2"	M27 x 2	665.85
KF-125BX700-S-G	125	700	1/2"	M27 x 2	728.10
KF-125BX800-S-G	125	800	1/2"	M27 x 2	790.40
KF-125BX900-S-G	125	900	1/2"	M27 x 2	852.70

0334	Ø mm	Stroke mm	BSPB	Rod Thread	€
KF-125BX1000-S-G	125	1000	1/2"	M27 x 2	915.20
KF-160BX25-S-G	160	25	3/4"	M36 x 2	478.50
KF-160BX50-S-G	160	50	3/4"	M36 x 2	499.60
KF-160BX75-S-G	160	75	3/4"	M36 x 2	521.80
KF-160BX80-S-G	160	80	3/4"	M36 x 2	544.05
KF-160BX100-S-G	160	100	3/4"	M36 x 2	545.25
KF-160BX125-S-G	160	125	3/4"	M36 x 2	567.70
KF-160BX150-S-G	160	150	3/4"	M36 x 2	591.15
KF-160BX160-S-G	160	160	3/4"	M36 x 2	614.75
KF-160BX175-S-G	160	175	3/4"	M36 x 2	626.10
KF-160BX200-S-G	160	200	3/4"	M36 x 2	637.05
KF-160BX250-S-G	160	250	3/4"	M36 x 2	684.20
KF-160BX300-S-G	160	300	3/4"	M36 x 2	728.75
KF-160BX350-S-G	160	350	3/4"	M36 x 2	775.75
KF-160BX400-S-G	160	400	3/4"	M36 x 2	821.70
KF-160BX450-S-G	160	450	3/4"	M36 x 2	868.70
KF-160BX500-S-G	160	500	3/4"	M36 x 2	914.60
KF-160BX600-S-G	160	600	3/4"	M36 x 2	1010.10
KF-160BX700-S-G	160	700	3/4"	M36 x 2	1105.65
KF-160BX800-S-G	160	800	3/4"	M36 x 2	1201.15
KF-160BX900-S-G	160	900	3/4"	M36 x 2	1296.60
KF-160BX1000-S-G	160	1000	3/4"	M36 x 2	1392.30
KF-200BX25-S-G	200	25	3/4"	M36 x 2	614.00
KF-200BX50-S-G	200	50	3/4"	M36 x 2	640.15
KF-200BX75-S-G	200	75	3/4"	M36 x 2	668.80
KF-200BX80-S-G	200	80	3/4"	M36 x 2	697.45
KF-200BX100-S-G	200	100	3/4"	M36 x 2	711.45
KF-200BX125-S-G	200	125	3/4"	M36 x 2	726.20
KF-200BX150-S-G	200	150	3/4"	M36 x 2	754.85
KF-200BX160-S-G	200	160	3/4"	M36 x 2	783.55
KF-200BX175-S-G	200	175	3/4"	M36 x 2	799.10
KF-200BX200-S-G	200	200	3/4"	M36 x 2	812.20
KF-200BX250-S-G	200	250	3/4"	M36 x 2	869.65
KF-200BX300-S-G	200	300	3/4"	M36 x 2	927.00
KF-200BX350-S-G	200	350	3/4"	M36 x 2	984.45
KF-200BX400-S-G	200	400	3/4"	M36 x 2	1041.80
KF-200BX450-S-G	200	450	3/4"	M36 x 2	1099.25
KF-200BX500-S-G	200	500	3/4"	M36 x 2	1156.40
KF-200BX600-S-G	200	600	3/4"	M36 x 2	1273.90
KF-200BX700-S-G	200	700	3/4"	M36 x 2	1391.20
KF-200BX800-S-G	200	800	3/4"	M36 x 2	1511.10
KF-200BX900-S-G	200	900	3/4"	M36 x 2	1631.10
KF-200BX1000-S-G	200	1000	3/4"	M36 x 2	1751.00

ISO 15552 bevestigingen

Tech Data
3012



Flensbevestiging voor/achter 'FA'

0334	Ø mm	€
F-KF32FA	32	8.30
F-KF40FA	40	8.70
F-KF50FA	50	10.25
F-KF63FA	63	13.20
F-KF80FA	80	20.35
F-KF100FA	100	24.00
F-KF125FA	125	65.10
F-KF160FA	160	106.35
F-KF200FA	200	151.05

Tech Data
3013



Zwenktafbevestiging voor 'FTC'

0334	Ø mm	€
F-KF32FTC	32	25.70
F-KF40FTC	40	26.00
F-KF50FTC	50	35.65
F-KF63FTC	63	42.25
F-KF80FTC	80	52.00
F-KF100FTC	100	83.65
F-KF125FTC	125	115.60
F-KF160FTC	160	201.70
F-KF200FTC	200	306.00

Tech Data
3014



Zwenktaf/gaffelbevestiging voor 'TF'

0334	Ø mm	€
F-KF32TF	32	15.85
F-KF40TF	40/50	25.70
F-KF63TF	63/80	44.95
F-KF125TF	100/125	104.20
F-KF160TF	160	186.55
F-KF200TF	200	225.20

Tech Data
3015



Zwenktafsteun 'TM'

0334	Ø mm	€
F-KF32TM	32	12.85
F-KF40TM	40/50	15.85
F-KF63TM	63/80	22.45
F-KF125TM	100/125	31.95
F-KF160TM	160/200	46.30

Tech Data
3016



Enkel achterscharnier 'CA'

0334	Ø mm	€
F-KF32CA	32	8.95
F-KF40CA	40	9.35
F-KF50CA	50	11.40
F-KF63CA	63	12.75
F-KF80CA	80	19.65
F-KF100CA	100	23.90
F-KF125CA	125	72.55
F-KF160CA	160	109.30
F-KF200CA	200	145.30

Tech Data
3017



Dubbel achterscharnier 'CB'

0334	Ø mm	€
F-KF32CB	32	10.75
F-KF40CB	40	11.80
F-KF50CB	50	14.80
F-KF63CB	63	15.80
F-KF80CB	80	22.95
F-KF100CB	100	25.80
F-KF125CB	125	88.80
F-KF160CB	160	123.20
F-KF200CB	200	164.00

ISO 15552 bevestigingen

Tech Data
3018



Bevestigingssteun achter 'CR'

0334	Ø mm	€
F-KF32CR	32	10.90
F-KF40CR	40	11.65
F-KF50CR	50	13.65
F-KF63CR	63	15.15
F-KF80CR	80	23.05
F-KF100CR	100	29.80
F-KF125CR	125	90.85
F-KF160CR	160	131.00
F-KF200CR	200	177.55

Tech Data
3019



Bevestigingsvoet 'LB' (paar)

0334	Ø mm	€
F-KF32LB	32	5.75
F-KF40LB	40	6.35
F-KF50LB	50	7.00
F-KF63LB	63	8.60
F-KF80LB	80	9.45
F-KF100LB	100	10.90
F-KF125LB	125	43.80
F-KF160LB	160	68.30
F-KF200LB	200	97.55

Tech Data
3020



Zuigerstang gaffel 'YI'

0334	Ø mm	€
F-M10125YI	32	M10 x 1,25 8.60
F-M12125YI	40	M12 x 1,25 13.00
F-M16150YI	50/63	M16 x 1,5 20.50
F-M20150YI	80/100	M20 x 1,5 28.75
F-M27200YI	125	M27 x 2 42.80
F-M36200YI	160/200	M36 x 2 62.40

Tech Data
3021

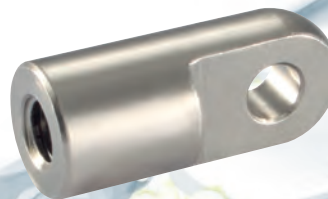

Zuigerstang gaffel 'I'

0334	Ø mm	€
F-M10125II	25/32	M10 x 1,25 6.30
F-M12125II	40	M12 x 1,25 8.35
F-M16150II	50/63	M16 x 1,5 12.20
F-M20150II	80/100	M20 x 1,5 20.80
F-M27200II	125	M27 x 2 28.30
F-M36200II	160/200	M36 x 2 45.55

Tech Data
3022



Uitlijnkop 'F'

0334	Ø mm	€
F-M10125F	25/32	M10 x 1,25 18.75
F-M12125F	40	M12 x 1,25 20.30
F-M16150F	50/63	M16 x 1,5 36.40
F-M20150F	80/100	M20 x 1,5 52.75

Tech Data
3023



Universele kogelstangkop 'U'

0334	Ø mm	€
F-M10125U	25/32	M10 x 1,25 9.85
F-M12125U	40	M12 x 1,25 11.55
F-M16150U	50/63	M16 x 1,5 20.60
F-M20150U	80/100	M20 x 1,5 32.85
F-M27200U	125	M27 x 2 63.05
F-M36200U	160/200	M36 x 2 95.25

KELM™
pneumatiek

Hydrauliek

Snel-
koppelingen

Afsluiters

Roestvast
staal

Fittingen

Lucht-
conditionering

Gereedschap

Pneumatiek

Diversen

Malleabele
fittingen
& staal

Ringleiding-
systemen

Slangen

Compressoren

ISO 15552 magneetschakelaars

Tech Data
3024



Tweepolig - NO met LED

0334	Ø mm	⚡	€
CS1-B1	32/40	5-240V AC/DC	21.20
CS1-B2	50/63	5-240V AC/DC	21.20
CS1-B3	80	5-240V AC/DC	21.20
CS1-B4	100	5-240V AC/DC	21.20
CS1-B5	125	5-240V AC/DC	21.20
CS1-B6	160	5-240V AC/DC	21.20
CS1-B7	200	5-240V AC/DC	21.20

Tech Data
3025



Driepolig - NO met LED - ingaande stroming NPN

0334	Ø mm	⚡	€
CS1-B1N	32/40	5-30V DC	36.55
CS1-B2N	50/63	5-30V DC	36.55
CS1-B3N	80	5-30V DC	36.55
CS1-B4N	100	5-30V DC	36.55
CS1-B5N	125	5-30V DC	36.55
CS1-B6N	160	5-30V DC	36.55
CS1-B7N	200	5-30V DC	36.55

Tech Data
3026



Driepolig - NO met LED - uitgaande stroming PNP

0334	Ø mm	⚡	€
CS1-B1P	32/40	5-30V DC	36.55
CS1-B2P	50/63	5-30V DC	36.55
CS1-B3P	80	5-30V DC	36.55
CS1-B4P	100	5-30V DC	36.55
CS1-B5P	125	5-30V DC	36.55
CS1-B6P	160	5-30V DC	36.55
CS1-B7P	200	5-30V DC	36.55

Gen 2 ISO 15552 magneetschakelaars



Tweepolig - NO met LED

0413	L m	⚡	€
CS1-E020	2	5-240V AC/DC	19.60
CS1-E050	5	5-240V AC/DC	23.35

ISO 15552 revisieset

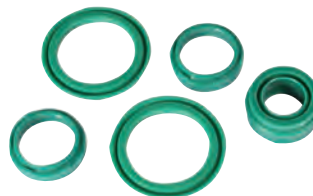

Standaard

0334	Ø	€
KFRK-32	32	8.50
KFRK-40	40	10.75
KFRK-50	50	12.80
KFRK-63	63	15.25
KFRK-80	80	19.30
KFRK-100	100	24.10
KFRK-125	125	30.00
KFRK-160	160	36.90
KFRK-200	200	45.00

Compacte persluchtcilinder

Accessoires en bevestiging selectie

Voor regelkoppelingen
zie pagina 572

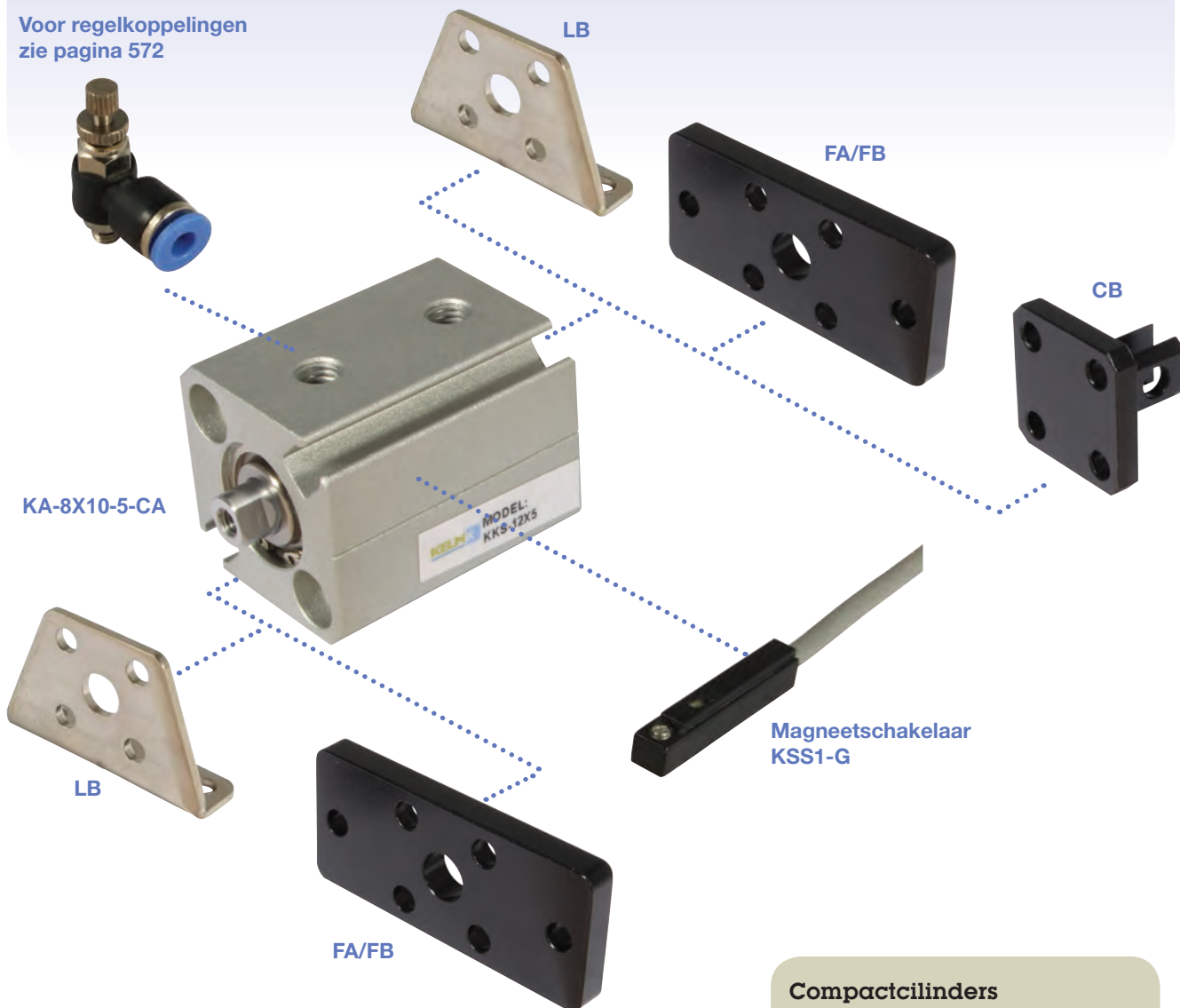

KA-8X10-5-CA

LB

FA/FB

FA/FB

CB

Magneetschakelaar
KSS1-G

Cilinders
op pagina 541-542

Bevestigingen
op pagina 543

Magneetschakelaars
op pagina 543

Compactcilinders

- CB - Gaffelscharnier achter
- FA/FB - Flensbevestiging voor/achter
- LB - Bevestigingsvoet (paar)
Tweepolige
magneetschakelaars
N/O met LED

Compacte persluchtcilinder

Technische informatie

KKS serie

Afmetingen

ø12 & ø16

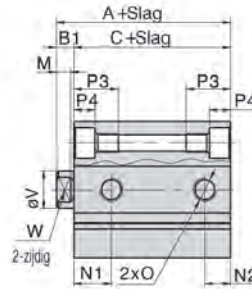
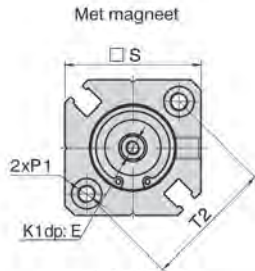

ø20 & ø25

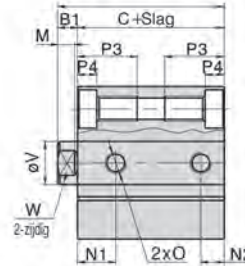
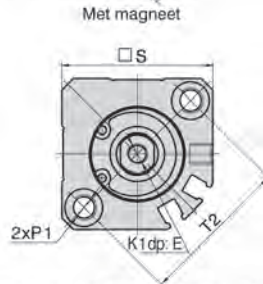

Model	Met magneet		B1	D	E	K1	M	N1		N2	
	A	C						Zonder magneet	Met magneet	Zonder magneet	Met magneet
12	31,5	28	3,6	6	8	M3 x 0,5	3,5	7,5	9	5	7
16	34	30,5	2,6	8	8	M4 x 0,7	3	8	9,5	5,5	3,5
20	36	31,5	4,5	7	8	M5 x 0,8	4	8	9,5	5,5	5,5
25	37,5	32,5	5	25	12	M6 x 1,0	4,5	11	9,5	5,5	5,5

Boring	D	P1	P3	P4	S	T1	T2	V	W
12	M5 x 0,8	2-zijdig ø6,5 Draad: M4 x 0,7 Gat: ø3,4	11	3,5	25	15,5	22	6	8
16	M5 x 0,8	2-zijdig ø6,3 Draad: M4 x 0,7 Gat: ø3,4	11	3,5	29	23	28	8	8
20	M5 x 0,8	2-zijdig ø9 Draad: M6 x 1,0 Gat: ø5,2	17	7	36	28,5	36	10	8
25	M5 x 0,8	2-zijdig ø9 Draad: M6 x 1,0 Gat: ø5,2	17	7	40	28	40	12	10

Afmetingen

ø32 to ø100
(Slag ≤ 100)

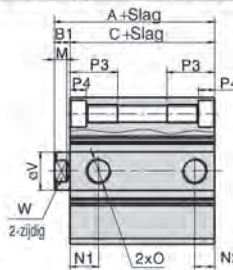
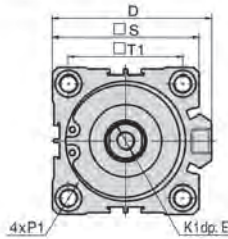

Model	Met magneet		B1	D	E	K1	M	N1		N2		
	A	C						Zonder magneet	Met magneet	Zonder magneet	Met magneet	
32	St-5	40	33	7	49,5	13	M8 x 1,25	6	7,5	10,5	6,5	7,5
	St->6								10,5	7,5		
40	46,5	39,5	7	57	13	M8 x 1,25	6	11	8			
50	St-5	48,5	40,5	8	71	15	M10 x 1,5	6,5	9	10,5	9	10,5
	St->6								10,5	10,5		
63	St-5	54	46	8	84	15	M10 x 1,5	6,5	14	15	9,5	10,5
	St->6								15	10,5		
80	63,5	53,5	10	104	20	M16 x 2,0	8,5	16	14			
100	75	63	12	120,5	26	M20 x 2,5	9,5	20	17,5			

Boring	D	P1	P3	P4	S	T1	T2	V	W
32	1/8"	2-zijdig ø9 Draad: M6 x 1,0 Gat: ø5,2	17	7	45	34	-	16	14
40	1/8"	2-zijdig ø9 Draad: M6 x 1,0 Gat: ø5,2	17	7	53	40	-	16	14
50	1/4"	2-zijdig ø11 Draad: M8 x 1,25 Gat: ø6,5	22	8	64	50	-	20	17
63	1/4"	2-zijdig ø14 Draad: M10 x 1,5 Gat: ø6,7	28,5	10,5	77	60	-	20	17
80	3/8"	2-zijdig ø17,5 Draad: M12 x 1,75 Gat: ø10,7	35,5	13,5	98	77	-	25	22
100	3/8"	2-zijdig ø17,5 Draad: M12 x 1,75 Gat: ø10,7	35,5	13,5	117	94	-	32	27

Binnenstructuur

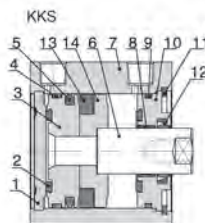

Nr.	Onderdeel	Materiaal
		12 & 16 20 25 32 40 - 100
1	Kap achterzijde	Aluminiumlegering
2	Buffer	TPU NBR
3	Zuiger	Messing Aluminiumlegering
4	Slijtring	Slijfvest materiaal
5	O-ring zuiger	NBR
6	Zuigerstang	Koolstofstaal 20µm verchroomd
7	Huls	Aluminiumlegering
8	Geleider	Slijfvest materiaal
9	Kap pakking	NBR
10	Kap voorzijde	Messing Aluminiumlegering
11	C clip	Verenstaal
12	Pakking kap voorzijde	NBR
13	Magneet	Gesinterd metaal Plastic
14	Magneethouder	Messing Aluminiumlegering

Compactcilinders

Werktemperatuur:
-20°C tot +80°C

Werkdruk:
1 tot 10 bar

Medium:

Geconditioneerde perslucht, gefilterd (40µm) en gesmeerd.

Met kunststof buffers

Behuizing: aluminium

Afdichtingen: NBR

Volledige technische specificaties worden op aanvraag verstrekt

Tech Data
3027

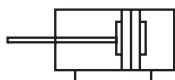

Magnetisch - dubbelwerkend

Raadpleeg de volgende pagina voor andere maten in deze reeks

0334	Ø mm	Stroke mm	Thread	Rod Thread	€
KKS-12X5	12	5	M5 x 0,8	M3 x 0,5	34.30
KKS-12X10	12	10	M5 x 0,8	M3 x 0,5	36.55
KKS-12X15	12	15	M5 x 0,8	M3 x 0,5	37.45
KKS-12X20	12	20	M5 x 0,8	M3 x 0,5	39.85
KKS-12X25	12	25	M5 x 0,8	M3 x 0,5	40.10
KKS-12X30	12	30	M5 x 0,8	M3 x 0,5	41.35
KKS-12X35	12	35	M5 x 0,8	M3 x 0,5	42.80
KKS-12X40	12	40	M5 x 0,8	M3 x 0,5	44.30
KKS-12X45	12	45	M5 x 0,8	M3 x 0,5	45.30
KKS-12X50	12	50	M5 x 0,8	M3 x 0,5	47.40
KKS-16X5	16	5	M5 x 0,8	M4 x 0,7	35.05
KKS-16X10	16	10	M5 x 0,8	M4 x 0,7	36.65
KKS-16X15	16	15	M5 x 0,8	M4 x 0,7	37.45
KKS-16X20	16	20	M5 x 0,8	M4 x 0,7	38.95
KKS-16X25	16	25	M5 x 0,8	M4 x 0,7	40.10
KKS-16X30	16	30	M5 x 0,8	M4 x 0,7	41.35
KKS-16X35	16	35	M5 x 0,8	M4 x 0,7	42.80
KKS-16X40	16	40	M5 x 0,8	M4 x 0,7	44.30
KKS-16X45	16	45	M5 x 0,8	M4 x 0,7	45.30
KKS-16X50	16	50	M5 x 0,8	M4 x 0,7	47.40
KKS-16X55	16	55	M5 x 0,8	M4 x 0,7	51.30
KKS-16X60	16	60	M5 x 0,8	M4 x 0,7	52.40
KKS-20X5	20	5	M5 x 0,8	M5 x 0,8	36.15
KKS-20X10	20	10	M5 x 0,8	M5 x 0,8	37.05
KKS-20X15	20	15	M5 x 0,8	M5 x 0,8	37.80
KKS-20X20	20	20	M5 x 0,8	M5 x 0,8	38.80
KKS-20X25	20	25	M5 x 0,8	M5 x 0,8	40.15
KKS-20X30	20	30	M5 x 0,8	M5 x 0,8	41.35
KKS-20X35	20	35	M5 x 0,8	M5 x 0,8	42.95
KKS-20X40	20	40	M5 x 0,8	M5 x 0,8	44.50
KKS-20X45	20	45	M5 x 0,8	M5 x 0,8	45.95
KKS-20X50	20	50	M5 x 0,8	M5 x 0,8	46.15
KKS-20X60	20	60	M5 x 0,8	M5 x 0,8	50.40
KKS-20X70	20	70	M5 x 0,8	M5 x 0,8	53.85
KKS-20X75	20	75	M5 x 0,8	M5 x 0,8	56.50
KKS-20X80	20	80	M5 x 0,8	M5 x 0,8	59.15
KKS-20X90	20	90	M5 x 0,8	M5 x 0,8	64.30
KKS-20X100	20	100	M5 x 0,8	M5 x 0,8	69.65
KKS-25X5	25	5	M5 x 0,8	M6 x 1	41.05
KKS-25X10	25	10	M5 x 0,8	M6 x 1	42.80
KKS-25X15	25	15	M5 x 0,8	M6 x 1	42.95
KKS-25X20	25	20	M5 x 0,8	M6 x 1	43.90
KKS-25X25	25	25	M5 x 0,8	M6 x 1	44.40
KKS-25X30	25	30	M5 x 0,8	M6 x 1	46.40
KKS-25X35	25	35	M5 x 0,8	M6 x 1	47.90

0334	Ø mm	Stroke mm	Thread	Rod Thread	€
KKS-25X40	25	40	M5 x 0,8	M6 x 1	49.05
KKS-25X45	25	45	M5 x 0,8	M6 x 1	50.15
KKS-25X50	25	50	M5 x 0,8	M6 x 1	51.15
KKS-25X60	25	60	M5 x 0,8	M6 x 1	54.30
KKS-25X70	25	70	M5 x 0,8	M6 x 1	56.65
KKS-25X75	25	75	M5 x 0,8	M6 x 1	58.65
KKS-25X80	25	80	M5 x 0,8	M6 x 1	61.15
KKS-25X90	25	90	M5 x 0,8	M6 x 1	66.50
KKS-25X100	25	100	M5 x 0,8	M6 x 1	72.55
KKS-32X5	32	5	1/8"	M8 x 1,25	47.15
KKS-32X10	32	10	1/8"	M8 x 1,25	49.10
KKS-32X15	32	15	1/8"	M8 x 1,25	50.65
KKS-32X20	32	20	1/8"	M8 x 1,25	52.25
KKS-32X25	32	25	1/8"	M8 x 1,25	53.95
KKS-32X30	32	30	1/8"	M8 x 1,25	54.55
KKS-32X35	32	35	1/8"	M8 x 1,25	56.60
KKS-32X40	32	40	1/8"	M8 x 1,25	58.60
KKS-32X45	32	45	1/8"	M8 x 1,25	60.65
KKS-32X50	32	50	1/8"	M8 x 1,25	63.85
KKS-32X60	32	60	1/8"	M8 x 1,25	66.30
KKS-32X70	32	70	1/8"	M8 x 1,25	70.45
KKS-32X75	32	75	1/8"	M8 x 1,25	72.85
KKS-32X80	32	80	1/8"	M8 x 1,25	76.50
KKS-32X90	32	90	1/8"	M8 x 1,25	81.65
KKS-32X100	32	100	1/8"	M8 x 1,25	87.30
KKS-32X125	32	125	1/8"	M8 x 1,25	109.05
KKS-32X150	32	150	1/8"	M8 x 1,25	123.45
KKS-32X175	32	175	1/8"	M8 x 1,25	137.85
KKS-32X200	32	200	1/8"	M8 x 1,25	156.05
KKS-32X250	32	250	1/8"	M8 x 1,25	189.35
KKS-40X5	40	5	1/8"	M8 x 1,25	55.20
KKS-40X10	40	10	1/8"	M8 x 1,25	55.50
KKS-40X15	40	15	1/8"	M8 x 1,25	60.05
KKS-40X20	40	20	1/8"	M8 x 1,25	60.40
KKS-40X25	40	25	1/8"	M8 x 1,25	61.55
KKS-40X30	40	30	1/8"	M8 x 1,25	64.80
KKS-40X35	40	35	1/8"	M8 x 1,25	66.75
KKS-40X40	40	40	1/8"	M8 x 1,25	68.05
KKS-40X45	40	45	1/8"	M8 x 1,25	70.95
KKS-40X50	40	50	1/8"	M8 x 1,25	71.60
KKS-40X60	40	60	1/8"	M8 x 1,25	77.45
KKS-40X70	40	70	1/8"	M8 x 1,25	83.10
KKS-40X75	40	75	1/8"	M8 x 1,25	85.50
KKS-40X80	40	80	1/8"	M8 x 1,25	88.95
KKS-40X90	40	90	1/8"	M8 x 1,25	95.25

Persluchtcilinders



Compactcilinders

Werktemperatuur:
-20°C tot +80°C

Werkdruk:
1 tot 10 bar

Medium:

Geconditioneerde perslucht, gefilterd (40µm) en gesmeerd.

Met kunststof buffers

Behuizing: aluminium

Afdichtingen: NBR

Volledige technische specificaties worden op aanvraag verstrekt

Tech Data
3027

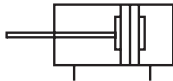

Magnetisch - dubbelwerkend

	0334	Ø mm	Stroke mm	Thread	Rod Thread	€	0334	Ø mm	Stroke mm	Thread	Rod Thread	€
	KKS-40X100	40	100	1/8"	M8 x 1,25	101.50	KKS-63X175	63	175	1/4"	M10 x 1,5	223.70
	KKS-40X125	40	125	1/8"	M8 x 1,25	128.55	KKS-63X200	63	200	1/4"	M10 x 1,5	242.95
	KKS-40X150	40	150	1/8"	M8 x 1,25	144.70	KKS-63X250	63	250	1/4"	M10 x 1,5	291.35
	KKS-40X175	40	175	1/8"	M8 x 1,25	160.55	KKS-80X5	80	5	3/8"	M16 x 2	139.35
	KKS-40X200	40	200	1/8"	M8 x 1,25	176.70	KKS-80X10	80	10	3/8"	M16 x 2	144.05
	KKS-40X250	40	250	1/8"	M8 x 1,25	219.80	KKS-80X15	80	15	3/8"	M16 x 2	147.05
	KKS-50X5	50	5	1/4"	M10 x 1,5	75.10	KKS-80X20	80	20	3/8"	M16 x 2	151.35
	KKS-50X10	50	10	1/4"	M10 x 1,5	76.65	KKS-80X25	80	25	3/8"	M16 x 2	155.40
	KKS-50X15	50	15	1/4"	M10 x 1,5	79.95	KKS-80X30	80	30	3/8"	M16 x 2	158.65
	KKS-50X20	50	20	1/4"	M10 x 1,5	80.80	KKS-80X35	80	35	3/8"	M16 x 2	162.95
	KKS-50X25	50	25	1/4"	M10 x 1,5	84.00	KKS-80X40	80	40	3/8"	M16 x 2	166.20
	KKS-50X30	50	30	1/4"	M10 x 1,5	86.95	KKS-80X45	80	45	3/8"	M16 x 2	170.25
	KKS-50X35	50	35	1/4"	M10 x 1,5	89.30	KKS-80X50	80	50	3/8"	M16 x 2	174.30
	KKS-50X40	50	40	1/4"	M10 x 1,5	89.65	KKS-80X60	80	60	3/8"	M16 x 2	182.75
	KKS-50X45	50	45	1/4"	M10 x 1,5	94.15	KKS-80X70	80	70	3/8"	M16 x 2	192.15
	KKS-50X50	50	50	1/4"	M10 x 1,5	95.85	KKS-80X75	80	75	3/8"	M16 x 2	197.00
	KKS-50X60	50	60	1/4"	M10 x 1,5	100.90	KKS-80X80	80	80	3/8"	M16 x 2	201.70
	KKS-50X70	50	70	1/4"	M10 x 1,5	106.15	KKS-80X90	80	90	3/8"	M16 x 2	213.35
	KKS-50X75	50	75	1/4"	M10 x 1,5	109.05	KKS-80X100	80	100	3/8"	M16 x 2	225.20
	KKS-50X80	50	80	1/4"	M10 x 1,5	111.70	KKS-80X125	80	125	3/8"	M16 x 2	276.60
	KKS-50X90	50	90	1/4"	M10 x 1,5	119.30	KKS-80X150	80	150	3/8"	M16 x 2	304.80
	KKS-50X100	50	100	1/4"	M10 x 1,5	126.60	KKS-80X175	80	175	3/8"	M16 x 2	332.95
	KKS-50X125	50	125	1/4"	M10 x 1,5	158.90	KKS-80X200	80	200	3/8"	M16 x 2	361.20
	KKS-50X150	50	150	1/4"	M10 x 1,5	176.50	KKS-80X250	80	250	3/8"	M16 x 2	428.95
	KKS-50X175	50	175	1/4"	M10 x 1,5	196.55	KKS-100X5	100	5	3/8"	M20 x 2,5	210.40
	KKS-50X200	50	200	1/4"	M10 x 1,5	214.65	KKS-100X10	100	10	3/8"	M20 x 2,5	214.85
	KKS-50X250	50	250	1/4"	M10 x 1,5	260.40	KKS-100X15	100	15	3/8"	M20 x 2,5	218.65
	KKS-63X5	63	5	1/4"	M10 x 1,5	85.50	KKS-100X20	100	20	3/8"	M20 x 2,5	223.65
	KKS-63X10	63	10	1/4"	M10 x 1,5	88.75	KKS-100X25	100	25	3/8"	M20 x 2,5	227.95
	KKS-63X15	63	15	1/4"	M10 x 1,5	91.90	KKS-100X30	100	30	3/8"	M20 x 2,5	232.90
	KKS-63X20	63	20	1/4"	M10 x 1,5	95.05	KKS-100X35	100	35	3/8"	M20 x 2,5	237.45
	KKS-63X25	63	25	1/4"	M10 x 1,5	98.65	KKS-100X40	100	40	3/8"	M20 x 2,5	241.50
	KKS-63X30	63	30	1/4"	M10 x 1,5	101.50	KKS-100X45	100	45	3/8"	M20 x 2,5	246.40
	KKS-63X35	63	35	1/4"	M10 x 1,5	108.25	KKS-100X50	100	50	3/8"	M20 x 2,5	251.15
	KKS-63X40	63	40	1/4"	M10 x 1,5	108.75	KKS-100X60	100	60	3/8"	M20 x 2,5	259.85
	KKS-63X45	63	45	1/4"	M10 x 1,5	110.75	KKS-100X70	100	70	3/8"	M20 x 2,5	269.80
	KKS-63X50	63	50	1/4"	M10 x 1,5	114.45	KKS-100X75	100	75	3/8"	M20 x 2,5	273.60
	KKS-63X60	63	60	1/4"	M10 x 1,5	120.85	KKS-100X80	100	80	3/8"	M20 x 2,5	279.25
	KKS-63X70	63	70	1/4"	M10 x 1,5	127.40	KKS-100X90	100	90	3/8"	M20 x 2,5	290.25
	KKS-63X75	63	75	1/4"	M10 x 1,5	128.20	KKS-100X100	100	100	3/8"	M20 x 2,5	301.45
	KKS-63X80	63	80	1/4"	M10 x 1,5	134.75	KKS-100X125	100	125	3/8"	M20 x 2,5	366.00
	KKS-63X90	63	90	1/4"	M10 x 1,5	143.25	KKS-100X150	100	150	3/8"	M20 x 2,5	394.15
	KKS-63X100	63	100	1/4"	M10 x 1,5	149.85	KKS-100X175	100	175	3/8"	M20 x 2,5	422.40
	KKS-63X125	63	125	1/4"	M10 x 1,5	185.00	KKS-100X200	100	200	3/8"	M20 x 2,5	450.60
	KKS-63X150	63	150	1/4"	M10 x 1,5	204.30	KKS-100X250	100	250	3/8"	M20 x 2,5	520.20

Compactcilinder bevestigingen

Tech Data
3028



Gaffelscharnier achter 'CB'

0334	Ø mm	€
KSS-12-CB	12	8.85
KSS-16-CB	16	9.10
KSS-20-CB	20	10.30
KSS-25-CB	25	11.40
KSS-32-CB	32	12.75
KSS-40-CB	40	14.10
KSS-50-CB	50	15.80
KSS-63-CB	63	17.95
KSS-80-CB	80	25.25
KSS-100-CB	100	25.75

Tech Data
3029



Flensbevestiging voor/achter 'FA/FB'

0334	Ø mm	€
KSS-12-FAFB	12	6.35
KSS-16-FAFB	16	6.45
KSS-20-FAFB	20	6.85
KSS-25-FAFB	25	7.75
KSS-32-FAFB	32	8.85
KSS-40-FAFB	40	9.50
KSS-50-FAFB	50	11.25
KSS-63-FAFB	63	14.55
KSS-80-FAFB	80	20.80
KSS-100-FAFB	100	25.70

Tech Data
3030



Bevestigingsvoet 'LB' (paar)

0334	Ø mm	To Suit Stroke	€
KSS-12-LB	12	Alle	5.30
KSS-16-LB	16	Alle	5.40
KSS-20-LB	20	>15	5.65
KSS-25-LB	25	>10	5.75
KSS-32-LB	32	>10	6.45
KSS-40-LB	40	Alle	6.75
KSS-50-LB	50	>15	7.45
KSS-63-LB	63	>10	10.30
KSS-80-LB	80	>20	11.35
KSS-100-LB	100	>15	12.90

Bevestigingsvoet 'LBS' (paar) - korte slaglengte

0334	Ø mm	To Suit Stroke	€
KSS-20-LBS-P1	20	<10	5.60
KSS-25-LBS-P1	25	<5	5.75
KSS-32-LBS-P1	32	<5	6.30
KSS-50-LBS-P1	50	<10	8.50
KSS-63-LBS-P1	63	<5	10.30
KSS-80-LBS-P1	80	<15	11.15
KSS-100-LBS-P1	100	<10	12.65

Compactcilinder magneetschakelaars

Tech Data
3031



Tweepolig - NO met LED - 2 meter

0334	Ø mm	€
KSS1-G	32-1005-240V AC/DC	15.05

Compactcilinder revisieset



Standaard

0334	Ø	€
KKSRK-12	12	3.30
KKSRK-16	16	3.45
KKSRK-20	20	4.30
KKSRK-25	25	4.60
KKSRK-32	32	4.85
KKSRK-40	40	6.25
KKSRK-50	50	7.50
KKSRK-63	63	9.10
KKSRK-80	80	14.00
KKSRK-100	100	16.70



Viton

0334	Ø	€
KKSRK-12-V	12	7.75
KKSRK-16-V	16	9.40
KKSRK-20-V	20	11.15
KKSRK-25-V	25	12.80
KKSRK-32-V	32	13.00
KKSRK-40-V	40	16.40
KKSRK-50-V	50	22.25
KKSRK-63-V	63	28.75
KKSRK-80-V	80	45.00
KKSRK-100-V	100	51.30

KELM™
pneumatiek

Hydrauliek

Snel-
koppelingen

Afsluiters

Roestvast
staal

Fittingen

Lucht-
conditionering

Gereedschap

Pneumatiek

Diversen

Malleabele
fittingen
& staal

Ringleiding-
systemen

Slangen

Compressoren

PNEUMATISCHE VENTIELEN

3/2 ventielen - mechanisch, elektrisch en luchtbediend

Roller



K3M3L-06

Zie pagina 546

**Hefboom/
hefboom**



K3M3Y-06

Zie pagina 546

Paddestoelknop



K3M3PM-06-B

Zie pagina 547

Stift



KCB-06

Zie pagina 549

Handschuifventiel



KSV-06

Zie pagina 550

Pilot/veer



CKA210-06-NC

Zie pagina 551

4/2 en 5/2 ventielen - elektrisch, hand- en luchtbediend

**4/2 hefboom/
hefboom**



DKHV210-06-S

Zie pagina 549

**5/2 hefboom/
hefboom**



DKH210-06

Zie pagina 550

Voet/veer



DKF210-08

Zie pagina 550

Overige ventielen

Drukregelventiel



K100-06

Zie pagina 550

Wisselventiel



KP080214

Zie pagina 556

**Basisventiel
- YES**



KP080494

Zie pagina 556

**Schakelaar
- 2 posities**



K3M3HS06
Zie pagina 547

Trek/druk



CKL110-06
Zie pagina 548

**Paddestoelknop
- vergrendeling**



KSCPL-06-R
Zie pagina 548

**Direct
werkend**



KCV1-06-B
Zie pagina 553

Solenoid/veer



CKV210-06-NC
Zie pagina 553

**Verstelbare
rolnok/veer**



ZMCJ-06-W
Zie pagina 549

Pilot/pilot



DKA220-06
Zie pagina 551

Solenoid/veer



DKV220-06
Zie pagina 554

**Solenoid/veer
- NAMUR**

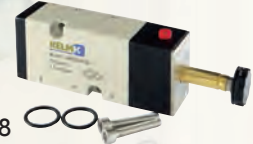

DKM310-08
Zie pagina 555

**Oscillatie
ventiel**



KP010444
Zie pagina 557

**High flow
pneumatische
timer**



KP000744
Zie pagina 558

2-hands veiligheidsunit



KP081564
Zie pagina 558



Werktemperatuur:
-20°C tot +70°C



Werkdruk:
0 tot 10 bar

Medium: Geconditioneerde perslucht. Gefilterd (40µm).

Materiaal: Aluminiumlegering

Afdichtingen: NBR

Volledige technische specificaties worden op aanvraag verstrekt

Tech Data
3097

Mechanisch bediende 3/2 ventielen - micro paneelmontage

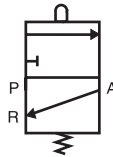

Stift

0335



K3M3B-05	M5	23.85
K3M3B-06	1/8"	23.85
K3M3B-08	1/4"	30.50

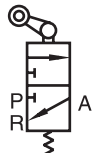

Rolarm - 1 richting

0335



K3M3L-05	M5	34.65
K3M3L-06	1/8"	34.65
K3M3L-08	1/4"	41.50

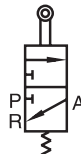

Rolarm

0335



K3M3R-05	M5	34.65
K3M3R-06	1/8"	34.65
K3M3R-08	1/4"	41.50



Handbediende 3/2 ventielen - micro paneelmontage

Hefboom/hefboom

0335



K3M3Y-05	M5	39.10
K3M3Y-06	1/8"	39.10
K3M3Y-08	1/4"	45.70



Roller

0335



K3M3V-05	M5	34.65
K3M3V-06	1/8"	34.65
K3M3V-08	1/4"	41.50



Werktemperatuur:
-20°C tot +70°C

Werkdruk:
0 tot 10 bar

Medium: Geconditioneerde perslucht. Gefilterd (40µm).
Materiaal: Aluminiumlegering
Afdichtingen: NBR
Volledige technische specificaties worden op aanvraag verstrekt

Tech Data
3097

Handbediende 3/2 ventielen - micro paneelmontage



Drukknop (omhuld)

0335



K3M3PF-05-B	M5	Zwart	39.10
K3M3PF-05-G	M5	Groen	39.10
K3M3PF-05-R	M5	Rood	39.10
K3M3PF-06-B	1/8"	Zwart	39.10
K3M3PF-06-G	1/8"	Groen	39.10
K3M3PF-06-R	1/8"	Rood	39.10
K3M3PF-08-B	1/4"	Zwart	45.70
K3M3PF-08-G	1/4"	Groen	45.70
K3M3PF-08-R	1/4"	Rood	45.70



Drukknop (extern)

0335



K3M3PP-05-B	M5	Zwart	39.10
K3M3PP-05-G	M5	Groen	39.10
K3M3PP-05-R	M5	Rood	39.10
K3M3PP-06-B	1/8"	Zwart	39.10
K3M3PP-06-G	1/8"	Groen	39.10
K3M3PP-06-R	1/8"	Rood	39.10
K3M3PP-08-B	1/4"	Zwart	45.70
K3M3PP-08-G	1/4"	Groen	45.70
K3M3PP-08-R	1/4"	Rood	45.70



Paddestoelknop

0335



K3M3PM-05-B	M5	Zwart	39.10
K3M3PM-05-G	M5	Groen	39.10
K3M3PM-05-R	M5	Rood	39.10
K3M3PM-06-B	1/8"	Zwart	39.10
K3M3PM-06-G	1/8"	Groen	39.10
K3M3PM-06-R	1/8"	Rood	39.10
K3M3PM-08-B	1/4"	Zwart	45.70
K3M3PM-08-G	1/4"	Groen	45.70
K3M3PM-08-R	1/4"	Rood	45.70

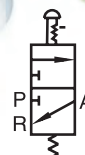

Paddestoelknop - vergrendeling

0335



K3M3PL-05-R	M5	Rood	39.10
K3M3PL-06-R	1/8"	Rood	39.10
K3M3PL-08-R	1/4"	Rood	45.70

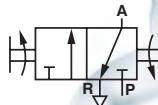

Schakelaar - 2 posities

0335



K3M3HS05	M5	39.10
K3M3HS06	1/8"	39.10
K3M3HS08	1/4"	45.70

KELMTM pneumatiek

Hydrauliek

Snelkoppelingen

Afsluiters

Roestvast staal

Fittingen

Luchtconditionering

Gereedschap

Pneumatiek

Diversen

Malleabele fittingen & staal

Ringleidingssystemen

Slangen

Compressoren

Hand- en mechanisch bediende ventielen



Werktemperatuur:
-20°C tot +70°C

Werkdruk:
0 tot 8 bar

Medium: Geconditioneerde perslucht, gefilterd (40µm) en gesmeerd.
Materiaal: Aluminiumlegering
Afdichtingen: NBR
Volledige technische specificaties worden op aanvraag verstrekt

Handbediende 3/2 ventielen

Tech Data
3032



Trek/druk

0335	BSPP	€
CKL110-06	1/8"	23.70
CKL210-08	1/4"	26.80
CKL310-10	3/8"	36.40

Tech Data
3038

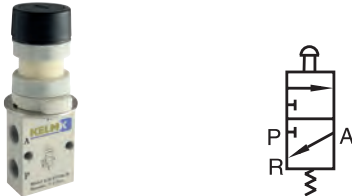

Drukknop (omhuld)

0335	BSPP	€	
KSCPF-06-B	1/8"	Zwart	22.45
KSCPF-06-G	1/8"	Groen	22.45
KSCPF-06-R	1/8"	Rood	22.45

Tech Data
3038



Drukknop (extern)

0335	BSPP	€	
KSCPP-06-B	1/8"	Zwart	22.45
KSCPP-06-G	1/8"	Groen	22.45
KSCPP-06-R	1/8"	Rood	22.45

Tech Data
3038



Paddestoelknop

0335	BSPP	€	
KSCPM-06-B	1/8"	Zwart	24.20
KSCPM-06-G	1/8"	Groen	24.20
KSCPM-06-R	1/8"	Rood	24.20

Tech Data
3038



Paddestoelknop - vergrendeling

0335	BSPP	€	
KSCPL-06-R	1/8"	Rood	24.10

Tech Data
3038



Hefboom/hefboom

0335	BSPP	€	
KSY-06	1/8"		24.10

Tech Data
3038

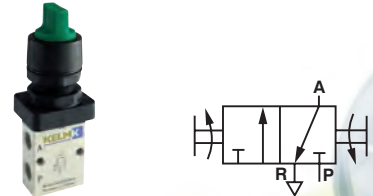

Schakelaar

0335	BSPP	€	
KSCHS-06-B	1/8"	Zwart	24.10
KSCHS-06-G	1/8"	Groen	24.10
KSCHS-06-R	1/8"	Rood	24.10

KELM™
pneumatiek

Hydrauliek

Snel-
koppelingen

Afsluiters

Roestvast
staal

Fittingen

Lucht-
conditionering

Gereedschap

Pneumatiek

Diversen

Malleabele
fittings &
staal

Ringleiding-
systemen

Slangen

Compressoren



Werktemperatuur:
-20°C tot +70°C

Mechanisch bediende 3/2 ventielen

Tech Data
3038

Werkdruk:
0 tot 8 bar

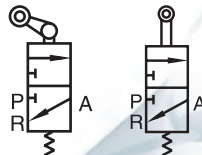

Rolnok

0335



KSCL-06	1/8"	Rolnok eenrichting hefboom	23.25
KSCR-06	1/8"	Rolnok hefboom	23.25
KSCV-06	1/8"	Rolnok	23.25

Tech Data
3038

Werkdruk:
0 tot 8 bar

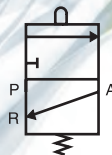

Stift

0335



KCB-06	1/8"		17.60
--------	------	--	-------

Tech Data
10061

Werkdruk:
0 tot 10 bar

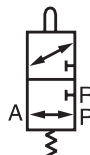

Rolnok/veer

0335



ZMCR-06-W	1/8"		76.75
-----------	------	--	-------

Tech Data
10061

Werkdruk:
0 tot 10 bar

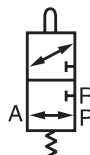

Verstelbare rolnok/veer

0335



ZMCJ-06-W	1/8"		79.90
-----------	------	--	-------

Tech Data
10061

Werkdruk:
0 tot 10 bar



Antenne/veer

0335



ZMCP-06-W	1/8"		79.90
-----------	------	--	-------

Handbediende 4/2 ventielen

Tech Data
3033

Werkdruk:
0 tot 10 bar

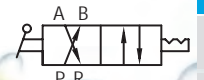

Hefboom/hefboom

0335



DKHV210-06-S	1/8"	35.25
DKHV310-08-S	1/4"	44.40
DKHV310-10-S	3/8"	44.40
DKHV410-15-S	1/2"	62.40
DKHV410-20-S	3/4"	63.35

Handbediende 4/3 ventielen

Tech Data
3033

Werkdruk:
0 tot 10 bar

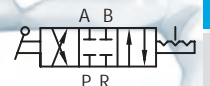

Hefboom/hefboom/hefboom - gesloten middenstand

0335



DKHV230-C-06-S	1/8"	35.25
DKHV330-C-08-S	1/4"	44.40
DKHV330-C-10-S	3/8"	44.40
DKHV430-C-15-S	1/2"	62.40
DKHV430-C-20-S	3/4"	63.35



Werktemperatuur:
-20°C tot +70°C

Werkdruk:
0 tot 8 bar

Handbediende 5/2 ventielen

Tech Data
3034



Trek/druk

0335



DKL110-06	1/8"	24.60
DKL210-08	1/4"	28.80
DKL310-10	3/8"	42.50

Tech Data
3041



Hefboom/hefboom

0335



DKH210-06	1/8"	31.95
DKH310-08	1/4"	46.00
DKH310-10	3/8"	46.00

Handbediende 5/3 ventielen

Tech Data
3045

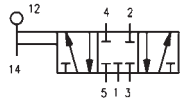

Hefboom/hefboom/hefboom - gesloten middenstand

0335



DKH230-C-06	1/8"	52.00
DKH230-C-08	1/4"	52.00
DKH330-C-10	3/8"	52.25

Tech Data
3046

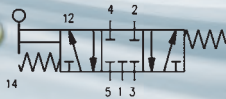

Hefboom/veer/hefboom - gesloten middenstand

0335



DKHA230-C-06	1/8"	61.15
DKHA230-C-08	1/4"	61.15
DKHA330-C-10	3/8"	62.40

Voetbediende 5/2 ventielen

Tech Data
3055

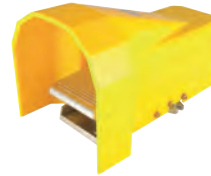

Voet/veer

0335



DKF210-08	-	49.60
DKF210-08G	Beschermd	59.05

Tech Data
3055

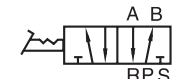

Voet/voet

0335



DKF210-08L	-	55.30
DKF210-08LG	Beschermd	66.05

Drukregelventielen

Tech Data
3056

Werkdruk:
0,5 tot 10 bar



Einrichting

0335



K100-06	1/8"	10.45
K200-08	1/4"	11.90
K300-10	3/8"	29.80
K300-15	1/2"	30.45

Handschuifventielen 3/2

Tech Data
3035

Werkdruk:
0-10 bar



BSP female

0335



KSV-06	1/8"	11.00
KSV-08	1/4"	11.85
KSV-10	3/8"	14.45
KSV-15	1/2"	25.05
KSV-20	3/4"	41.30
KSV-25	1"	61.60



Werktemperatuur:
-20°C tot +70°C

Werkdruk:
1,5 tot 8 bar

Medium: Geconditioneerde perslucht, gefilterd (40µm) en gesmeerd.
Materiaal: Aluminiumlegering **Afdichtingen:** NBR
Volledige technische specificaties worden op aanvraag verstrekt

Luchtbediende 3/2 ventielen

Tech Data
3036



Pilot/veer - NO

0335



CKA210-06-NO	1/8"	33.25
CKA210-08-NO	1/4"	36.55
CKA310-10-NO	3/8"	63.85

Tech Data
3036



Pilot/veer - NC

0335



CKA210-06-NC	1/8"	33.25
CKA210-08-NC	1/4"	36.55
CKA310-10-NC	3/8"	63.85

Tech Data
3036

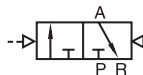
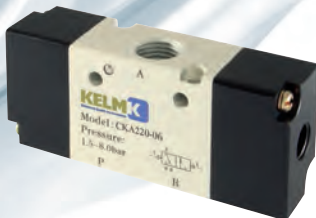

Pilot/pilot

0335



CKA220-06	1/8"	44.50
CKA220-08	1/4"	48.95
CKA320-10	3/8"	77.05

Luchtbediende 5/2 ventielen

Tech Data
3037



Pilot/veer

0335



DKA210-06	1/8"	43.50
DKA210-08	1/4"	43.50
DKA310-10	3/8"	48.60
DKA410-15	1/2"	66.30

Tech Data
3037



Pilot/pilot

0335



DKA220-06	1/8"	47.90
DKA220-08	1/4"	47.90
DKA320-10	3/8"	56.25
DKA420-15	1/2"	75.80

KELMK™
pneumatiek

Hydrauliek

Snel-
koppelingen

Afsluiters

Roestvast
staal

Fittingen

Lucht-
conditionering

Gereedschap

Pneumatiek

Diversen

Malleabele
fittingen
& staal

Ringleiding-
systemen

Slangen

Compressoren



Werktemperatuur:
-20°C tot +70°C

Werkdruk:
1,5 tot 8 bar

Medium: Geconditioneerde perslucht, gefilterd (40µm) en gesmeerd.
Materiaal: Aluminiumlegering **Afdichtingen:** NBR
Volledige technische specificaties worden op aanvraag verstrekt

Tech Data
3037

Luchtbediende 5/3 ventielen

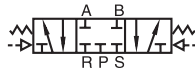

Pilot/pilot - gesloten middenstand

0335	BSPP	€
DKA230C-06	1/8"	69.55
DKA230C-08	1/4"	76.50
DKA330C-10	3/8"	84.15
DKA430C-15	1/2"	100.80



Pilot/pilot - middenstand druk

0335	BSPP	€
DKA230P-06	1/8"	69.55
DKA230P-08	1/4"	76.50
DKA330P-10	3/8"	84.15
DKA430P-15	1/2"	100.80



Pilot/pilot - middenstand ontlicht

0335	BSPP	€
DKA230E-06	1/8"	69.55
DKA230E-08	1/4"	76.50
DKA330E-10	3/8"	84.15
DKA430E-15	1/2"	100.80



Werktemperatuur:
-20°C tot +70°C

Werkdruk:
1,5 tot 8 bar

Medium: Schone perslucht. Gefilterd (40µm) & gesmeerd.
Materiaal: Aluminiumlegering **Afdichtingen:** NBR
Volledige technische specificaties worden op aanvraag verstrekt

Elektrisch bediende 3/2 ventielen

Tech Data
3107



Direct werkend - NC - M5

0335



KCV1-M5-B	24V DC	37.05
KCV1-M5-C	110V 50/60Hz	37.05
KCV1-M5-A	220V 50/60Hz	37.05

Tech Data
3107



Direct werkend - NC - 1/8"

0335



KCV1-06-B	24V DC	37.05
KCV1-06-C	110V 50/60Hz	37.05
KCV1-06-A	220V 50/60Hz	37.05

Tech Data
3039



Solenoid/veer - NO

0335



CKV210-06-NO	1/8"	29.90
CKV210-08-NO	1/4"	32.95
CKV310-10-NO	3/8"	48.60

Tech Data
3039



Solenoid/veer - NC

0335



CKV210-06-NC	1/8"	31.45
CKV210-08-NC	1/4"	34.55
CKV310-10-NC	3/8"	49.20

Tech Data
3039



Solenoid/solenoid

0335



CKV220-06	1/8"	50.20
CKV220-08	1/4"	55.25
CKV320-10	3/8"	76.95

Bevestigingscomponenten

Tech Data
3107



Koppelingsschroef en O-ring

0335



KCV1-P31

1.95

Tech Data
3107



Koppelingsschroef en (eind)bevestigingsmoer

0335



KCV1-P30

2.25

Tech Data
3107



Basisplaat

0335



KCV1-P32

2.25

KELM™
pneumatiek

Hydrauliek

Snel-
koppelingen

Afsluiters

Roestvast
staal

Fittingen

Lucht-
conditionering

Gereedschap

Pneumatiek

Diversen

Malleabele
fittingen
& staal

Ringleiding-
systemen

Slangen

Compressoren

Elektrisch bediende ventielen



Werktemperatuur:
-20°C tot +70°C

Werkdruk:
1,5 tot 8 bar

Medium: Schone perslucht. Gefilterd (40µm) & gesmeerd.
Materiaal: Aluminiumlegering **Afdichtingen:** NBR
Volledige technische specificaties worden op aanvraag verstrekt

Tech Data
3040

Elektrisch bediende 5/2 ventielen



Solenoid/veer

0335	BSPP	€
DKV210-06	1/8"	31.45
DKV210-08	1/4"	34.55
DKV310-10	3/8"	48.40
DKV410-15	1/2"	66.05



Solenoid/solenoid

0335	BSPP	€
DKV220-06	1/8"	48.90
DKV220-08	1/4"	51.55
DKV320-10	3/8"	76.95
DKV420-15	1/2"	94.80

Elektrisch bediende 5/3 ventielen

Alleen te gebruiken bij 5/2 ventielen



Solenoid/solenoid - gesloten middenstand

0335	BSPP	€
DKV230C-06	1/8"	68.80
DKV230C-08	1/4"	71.70
DKV330C-10	3/8"	108.95
DKV430C-15	1/2"	125.00



Solenoid/solenoid - middenstand ontucht

0335	BSPP	€
DKV230E-06	1/8"	68.80
DKV230E-08	1/4"	68.80
DKV330E-10	3/8"	103.45
DKV430E-15	1/2"	124.45



Solenoid/solenoid - middenstand druk

0335	BSPP	€
DKV230P-06	1/8"	69.95
DKV230P-08	1/4"	77.00
DKV330P-10	3/8"	103.45
DKV430P-15	1/2"	123.15



Basisplaten

Tech Data
3042

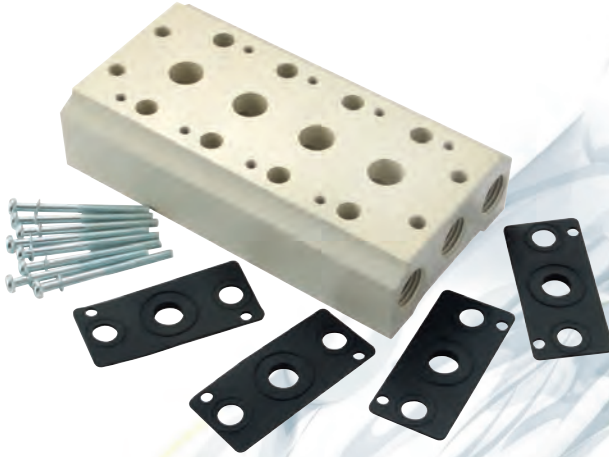

1/4" BSP

0335	No. of Stations	€
B00KM-1F	1	10.50
B00KM-2F	2	11.00
B00KM-3F	3	16.50
B00KM-4F	4	21.40
B00KM-5F	5	26.45
B00KM-6F	6	32.25
B00KM-8F	8	42.95
B00KM-10F	10	52.85

3/8" BSP

0335	No. of Stations	€
C00KM-1F	1	12.90
C00KM-2F	2	14.95
C00KM-3F	3	22.70
C00KM-4F	4	30.30
C00KM-5F	5	37.95
C00KM-6F	6	45.55
C00KM-8F	8	60.65
C00KM-10F	10	75.80

Het maximaal beschikbare aantal stations is 8

1/2" BSP

0335	No. of Stations	€
D00KM-1F	1	24.15
D00KM-2F	2	29.35
D00KM-3F	3	43.25
D00KM-4F	4	58.65
D00KM-5F	5	73.35
D00KM-6F	6	87.95
D00KM-8F	8	120.10

Blindplaten

Tech Data
3042

0335	To Suit	€
A00KM-B	A-serie	0.95
B00KM-B	B-serie	0.65
C00KM-B	C-serie	1.45
D00KM-B	D-serie	3.70

Namur 5/2 ventielen

Tech Data
3043

Solenoid/veer

0335	BSPP	€
DKM310-08	1/4"	59.65
DKM310-10	3/8"	65.70

Tech Data
3043

Solenoid/solenoid

0335	BSPP	€
DKM320-08	1/4"	90.85
DKM320-10	3/8"	99.95

Spoelen met stekker

Tech Data
3044

Spoel en LED-connector

0335	€	
K-12DC	12V DC	20.60
K-24DC	24V DC	17.90
K-24AC	24V 50/60Hz	17.90
K-110AC	110V 50/60Hz	17.90
K-220AC	220V 50/60Hz	17.90



Werktemperatuur:
0°C tot +60°C

Werkdruk:
2 tot 10 bar

Tech Data
3098

Basisventiel - NOT

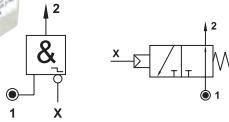

4mm push-in

0335

KP080394



30.35

Basisventiel - YES

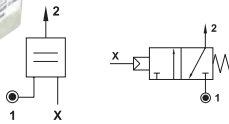

4mm push-in

0335

KP080494



30.35

Tweedrukventiel - AND

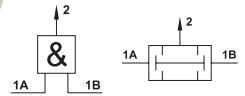

4mm push-in

0335

KP080254



20.70

Monostabiel ventiel

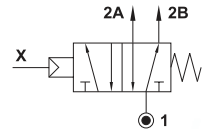

4mm push-in

0335

KP040034



53.60

Wisselventiel - OR

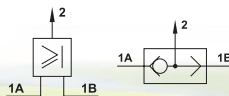

4mm push-in

0335

KP080214



20.70

KELM™
pneumatiek

Hydrauliek

Snel-
koppelingen

Afsluiters

Roestvast
staal

Fittingen

Lucht-
conditionering

Gereedschap

Pneumatiek

Diversen

Malleabele
fittingen
& staal

Ringleiding-
systemen

Slangen

Compressoren



Werktemperatuur:
0°C tot +60°C

Impuls ventielen

Tech Data
3099

Werkdruk:
2 tot 10 bar



1/8" BSP - NO

0335

KP100014



51.40

Tech Data
3099

Werkdruk:
2 tot 10 bar



1/8" BSP - NC

0335

KP100094



51.40

Oscillatie ventielen

Tech Data
3100

Werkdruk:
2 tot 10 bar

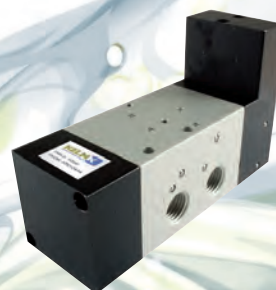

1/4" BSP - continue cyclus

0335

KP010444



154.35

Tech Data
3100

Werkdruk:
2 tot 10 bar

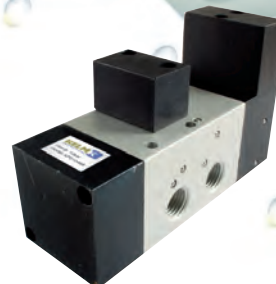

1/4" BSP - luchtbediend

0335

KP010464



164.90

Flip Flop ventiel

Tech Data
3103

Werkdruk:
3 tot 10 bar



1/4" BSP - luchtbediend

0335

KP100354



175.30

KELM™
pneumatiek

Hydrauliek

Snel-
koppelingen

Afsluiters

Roestvast
staal

Fittingen

Lucht-
conditionering

Gereedschap

Pneumatiek

Diversen

Malleabele
fittingen
& staal

Ringleiding-
systemen

Slangen

Compressoren



Werktemperatuur:
0°C tot +60°C

High flow pneumatische timer

Tech Data
3101

Werkdruk:
2 tot 10 bar



Voor automatische teruggang - 1/8" BSP

0335

KP000744



115.40

Vacuümgedreven vloeistofspoeier

Tech Data
3102

Werkdruk:
3 tot 8 bar



M5

0335

KP2005



30.35

Veiligheidsunit (voor 2-handsgebruik)

Tech Data
3099



Werktemperatuur:
0°C tot +60°C

Werkdruk:
3 tot 8 bar

4mm push-in

0341

KP081564



442.55

Basis veiligheidsunit - 1/8" BSP

0341

KPBU081564



172.50



Deze geassembleerde unit is speciaal ontworpen met de veiligheid van operators in gedachten.

De unit vereist beide handen van de operator om te functioneren. Als beide 3/2 drukknop ventielen niet geactiveerd zijn binnen 0.5 seconden zal de unit niet in werking worden gesteld.



Pneumatische kogelvibratoren

Tech Data
1012



Max. omgevings-temperatuur
+100°C



Werkdruk
Minimaal 2 bar
Maximaal 6 bar

- Deze pneumatische kogelvibrator veroorzaakt door middel van een roterende kogel een roterende trilling. De frequentie kan geregeld worden door aanpassing van de persluchtdruk
- Toepassing: Het in beweging houden, verdichten en lostrillen van stortgoed. Voorbeelden: Chemische poeders, graan, zand, grind en cement.
- Voor binnen- en buitengebruik, maar niet bestand tegen onderdempeling in vloeistof.

BSP female

0314				Air Consumption at 6 bar	V.P.M. 6 bar	€
JM8	1/4"	2	6	195 liter	35100	92.60
JM10	1/4"	2	6	200 liter	34100	97.20
JM13	1/4"	2	6	225 liter	22510	134.30
JM16	1/4"	2	6	280 liter	19510	166.65
JM20	1/4"	2	6	340 liter	16510	199.80
JM25	1/4"	2	6	425 liter	14100	222.05
JM30	3/8"	2	6	570 liter	12510	288.65
JM36	3/8"	2	6	675 liter	10100	319.75

Pneumatische turbinevibratoren

Tech Data
1013



Max. omgevings-temperatuur
+120°C



Werkdruk
Minimaal 2 bar
Maximaal 6 bar

- Deze pneumatische turbinevibrator veroorzaakt door middel van een excentrisch roterende rotor een roterende trilling. De frequentie kan geregeld worden door aanpassing van de persluchtdruk.
- Toepassing: Het in beweging houden, verdichten en lostrillen van stortgoed in o.a. silo's. Voorbeelden: Chemische poeders, graan, zand, grind en cement.

BSP female

0314				Air Consumption at 6 bar	V.P.M. 6 bar	€
JMT8	1/8"	2	6	120 liter	45900	133.20
JMT10	1/4"	2	6	120 liter	37600	148.25
JMT13	1/4"	2	6	290 liter	39800	177.65
JMT16	1/4"	2	6	290 liter	24100	186.50
JMT20	1/4"	2	6	455 liter	23100	249.25
JMT25	3/8"	2	6	455 liter	17100	277.90
JMT30	3/8"	2	6	745 liter	16100	502.05
JMT36	3/8"	2	6	745 liter	13000	564.75

- Mais
- Cement
- Chemische poeders
- Zand
- Grind

Pneumatische zuigervibratoren

Tech Data
10158



Max. omgevings-temperatuur
+100°C



Werkdruk
Minimaal 2 bar
Maximaal 6 bar

Aluminium - BSP female

0314				Air Consumption at 6 bar	€
KFP-12-M	1/8"	2	6	20 liter	259.90
KFP-18-M	1/8"	2	6	55 liter	270.70
KFP-25-M	1/4"	2	6	88 liter	270.70
KFP-35-M	1/4"	2	6	145 liter	361.00

Perslucht cilinders



ISO 6432 rondcilinders

Medium: Gefilterde, gesmeerde en ongesmeerde perslucht
 Materiaal: Cilinderbuis: RVS AISI-304
 Zuigerstang: RVS AISI-303
 Kappen: geanodiseerd aluminium
 Dichting: NBR/PU

Temperatuur: 0°C tot 80°C
 (-20°C bij droge lucht)

Maximale werkdruk: 1 tot 10 bar

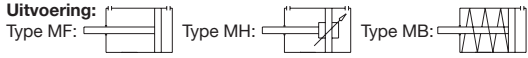

Type MF - magnetisch - dubbelwerkend

6710	Ø mm	Stroke mm	Bore	Stroke	Thread	Price
MF0080010	8	10	M5	M12x1.25	M4x0.7	32.35
MF0080025	8	25	M5	M12x1.25	M4x0.7	33.85
MF0080050	8	50	M5	M12x1.25	M4x0.7	35.55
MF0080080	8	80	M5	M12x1.25	M4x0.7	36.40
MF0080100	8	100	M5	M12x1.25	M4x0.7	37.30
MF0080125	8	125	M5	M12x1.25	M4x0.7	38.80
MF0100010	10	10	M5	M12x1.25	M4x0.7	32.55
MF0100025	10	25	M5	M12x1.25	M4x0.7	34.20
MF0100050	10	50	M5	M12x1.25	M4x0.7	35.80
MF0100080	10	80	M5	M12x1.25	M4x0.7	36.60
MF0100100	10	100	M5	M12x1.25	M4x0.7	37.50
MF0100125	10	125	M5	M12x1.25	M4x0.7	34.45
MF0120010	12	10	M5	M16x1.5	M6x1	34.65
MF0120025	12	25	M5	M16x1.5	M6x1	35.25
MF0120050	12	50	M5	M16x1.5	M6x1	36.85
MF0120080	12	80	M5	M16x1.5	M6x1	37.55
MF0120100	12	100	M5	M16x1.5	M6x1	38.95
MF0120125	12	125	M5	M16x1.5	M6x1	35.30
MF0120160	12	160	M5	M16x1.5	M6x1	40.65
MF0120200	12	200	M5	M16x1.5	M6x1	42.25
MF0120250	12	250	M5	M16x1.5	M6x1	44.45
MF0160010	16	10	M5	M16x1.5	M6x1	36.40
MF0160025	16	25	M5	M16x1.5	M6x1	37.30
MF0160050	16	50	M5	M16x1.5	M6x1	38.80
MF0160080	16	80	M5	M16x1.5	M6x1	40.30
MF0160100	16	100	M5	M16x1.5	M6x1	40.90
MF0160125	16	125	M5	M16x1.5	M6x1	41.60
MF0160160	16	160	M5	M16x1.5	M6x1	44.05
MF0160200	16	200	M5	M16x1.5	M6x1	45.50
MF0160250	16	250	M5	M16x1.5	M6x1	47.25
MF0200010	20	10	1/8"	M22x1.5	M8x1.25	37.85
MF0200025	20	25	1/8"	M22x1.5	M8x1.25	38.80
MF0200050	20	50	1/8"	M22x1.5	M8x1.25	40.30
MF0200080	20	80	1/8"	M22x1.5	M8x1.25	42.40
MF0200100	20	100	1/8"	M22x1.5	M8x1.25	44.15
MF0200125	20	125	1/8"	M22x1.5	M8x1.25	44.80
MF0200160	20	160	1/8"	M22x1.5	M8x1.25	46.20
MF0200200	20	200	1/8"	M22x1.5	M8x1.25	49.30
MF0200250	20	250	1/8"	M22x1.5	M8x1.25	52.25
MF0200320	20	320	1/8"	M22x1.5	M8x1.25	55.25
MF0250010	25	10	1/8"	M22x1.5	M10x1.25	42.40
MF0250025	25	25	1/8"	M22x1.5	M10x1.25	43.20
MF0250050	25	50	1/8"	M22x1.5	M10x1.25	44.60
MF0250080	25	80	1/8"	M22x1.5	M10x1.25	46.20
MF0250100	25	100	1/8"	M22x1.5	M10x1.25	46.90
MF0250125	25	125	1/8"	M22x1.5	M10x1.25	49.30
MF0250160	25	160	1/8"	M22x1.5	M10x1.25	51.35
MF0250200	25	200	1/8"	M22x1.5	M10x1.25	54.55
MF0250250	25	250	1/8"	M22x1.5	M10x1.25	58.20
MF0250320	25	320	1/8"	M22x1.5	M10x1.25	63.05



Type MH - magnetisch - dubbelwerkend - instelbare buffering

Tech Data 10261

6710	Ø mm	Stroke mm	Bore	Stroke	Thread	Price
MH0160025	16	25	M5	M16x1.5	M6x1	49.85
MH0160050	16	50	M5	M16x1.5	M6x1	59.95
MH0160080	16	80	M5	M16x1.5	M6x1	51.70
MH0160100	16	100	M5	M16x1.5	M6x1	52.80
MH0160125	16	125	M5	M16x1.5	M6x1	53.75
MH0160160	16	160	M5	M16x1.5	M6x1	65.50
MH0160200	16	200	M5	M16x1.5	M6x1	66.65
MH0160250	16	250	M5	M16x1.5	M6x1	68.05
MH0200025	20	25	1/8"	M22x1.5	M8x1.25	51.70
MH0200050	20	50	1/8"	M22x1.5	M8x1.25	63.30
MH0200080	20	80	1/8"	M22x1.5	M8x1.25	64.55
MH0200100	20	100	1/8"	M22x1.5	M8x1.25	65.60
MH0200125	20	125	1/8"	M22x1.5	M8x1.25	66.75
MH0200160	20	160	1/8"	M22x1.5	M8x1.25	68.05
MH0200200	20	200	1/8"	M22x1.5	M8x1.25	69.05
MH0200250	20	250	1/8"	M22x1.5	M8x1.25	70.25
MH0200320	20	320	1/8"	M22x1.5	M8x1.25	72.45
MH0250025	25	25	1/8"	M22x1.5	M10x1.25	56.55
MH0250050	25	50	1/8"	M22x1.5	M10x1.25	69.05
MH0250080	25	80	1/8"	M22x1.5	M10x1.25	70.25
MH0250100	25	100	1/8"	M22x1.5	M10x1.25	71.40
MH0250125	25	125	1/8"	M22x1.5	M10x1.25	61.40
MH0250160	25	160	1/8"	M22x1.5	M10x1.25	73.50
MH0250200	25	200	1/8"	M22x1.5	M10x1.25	74.85
MH0250250	25	250	1/8"	M22x1.5	M10x1.25	76.05
MH0250320	25	320	1/8"	M22x1.5	M10x1.25	78.50



Type MB - magnetisch - enkelwerkend

Tech Data 10262

6710	Ø mm	Stroke mm	Bore	Stroke	Thread	Price
MB0080010	8	10	M5	M12x1.25	M4x0.7	28.40
MB0080025	8	25	M5	M12x1.25	M4x0.7	29.70
MB0080050	8	50	M5	M12x1.25	M4x0.7	35.35
MB0100010	10	10	M5	M12x1.25	M4x0.7	32.35
MB0100025	10	25	M5	M12x1.25	M4x0.7	33.95
MB0100050	10	50	M5	M12x1.25	M4x0.7	31.40
MB0120010	12	10	M5	M16x1.5	M6x1	34.45
MB0120025	12	25	M5	M16x1.5	M6x1	31.40
MB0120050	12	50	M5	M16x1.5	M6x1	36.65
MB0160010	16	10	M5	M16x1.5	M6x1	36.25
MB0160025	16	25	M5	M16x1.5	M6x1	37.15
MB0160050	16	50	M5	M16x1.5	M6x1	38.65
MB0200010	20	10	1/8"	M22x1.5	M8x1.25	37.60
MB0200025	20	25	1/8"	M22x1.5	M8x1.25	38.65
MB0200050	20	50	1/8"	M22x1.5	M8x1.25	40.15
MB0250010	25	10	1/8"	M22x1.5	M10x1.25	42.25
MB0250025	25	25	1/8"	M22x1.5	M10x1.25	43.00
MB0250050	25	50	1/8"	M22x1.5	M10x1.25	44.45

KELM™
pneumatiek

Hydrauliek

Snel-
koppelingen

Afsluiters

Roestvast
staal

Fittingen

Lucht-
conditionering

Gereedschap

Pneumatiek

Diversen

Malleerbare
fittingen
& staal

Ringleiding-
systemen

Slangen

Compressoren

ISO 6432 bevestigingen



Type MFL - flensbevestiging

6710		€
MFL008	8/10	1.65
MFL012	12/16	1.80
MFL020	20/25	2.35



Type MPD - bevestigingsvoet

6710		€
MPD008	8/10	1.65
MPD012	12/16	2.20
MPD020	20/25	4.55



Type MCC - scharnierbevestiging

6710		€
MCC008	8/10	2.75
MCC012	12/16	5.05
MCC020	20/25	6.45



Type DA - moer voor eindkap

6710			€
DAM12	8/10	M12x1.25	0.75
DAM16	12/16	M16x1.5	0.90
DAM22	20/25	M22x1.25	2.55



Type DA - moer voor zuigerstang

6710			€
DAM4	8/10	M4x0.7	0.05
DAM6	12/16	M6x1	0.05
DAM8	20	M8x1.25	0.20
DAM10	25	M10x1.25	0.25



Type FC - zuigerstang gaffel met pen

6710			€
FC008	8/10	M4x0.7	3.30
FC012	12/16	M6x1	2.75
FC020	20	M8x1.25	3.30
FC025	25	M10x1.25	4.15



Type TF - kogelstangkop - zelfsmarend

6710			€
TF008	8/10	M4x0.7	20.90
TF012	12/16	M6x1	17.05
TF020	20	M8x1.25	17.60
TF025	25	M10x1.25	18.85

ISO 6432 RVS rondcilinders

Medium:

Gefilterde, gesmeerde en ongesmeerde perslucht

Materiaal: Cilinderbuis: RVS AISI-304

Zuigerstang: RVS AISI-316

Kappen: RVS AISI-304

Dichting: NBR/PU

Uitvoering:

Temperatuur: 0°C tot 80°C **Maximale werkdruk:** 2 tot 10 bar



Type MFI - magnetisch - dubbelwerkend

6710							€
MFI0160010	16	10	M5	M16x1.5	M6x1		97.40
MFI0160025	16	25	M5	M16x1.5	M6x1		98.05
MFI0160050	16	50	M5	M16x1.5	M6x1		99.15
MFI0160080	16	80	M5	M16x1.5	M6x1		100.45
MFI0160100	16	100	M5	M16x1.5	M6x1		101.30
MFI0160125	16	125	M5	M16x1.5	M6x1		102.40
MFI0160160	16	160	M5	M16x1.5	M6x1		104.55
MFI0160200	16	200	M5	M16x1.5	M6x1		106.25
MFI0160250	16	250	M5	M16x1.5	M6x1		108.40
MFI0160320	16	320	M5	M16x1.5	M6x1		111.45
MFI0200010	20	10	1/8"	M22x1.5	M8x1.25		111.95
MFI0200025	20	25	1/8"	M22x1.5	M8x1.25		112.65
MFI0200050	20	50	1/8"	M22x1.5	M8x1.25		113.95
MFI0200080	20	80	1/8"	M22x1.5	M8x1.25		115.35
MFI0200100	20	100	1/8"	M22x1.5	M8x1.25		116.40
MFI0200125	20	125	1/8"	M22x1.5	M8x1.25		117.55
MFI0200160	20	160	1/8"	M22x1.5	M8x1.25		120.10
MFI0200200	20	200	1/8"	M22x1.5	M8x1.25		122.10
MFI0200250	20	250	1/8"	M22x1.5	M8x1.25		124.60
MFI0200320	20	320	1/8"	M22x1.5	M8x1.25		128.00
MFI0250010	25	10	1/8"	M22x1.5	M10x1.25		118.65
MFI0250025	25	25	1/8"	M22x1.5	M10x1.25		119.70
MFI0250050	25	50	1/8"	M22x1.5	M10x1.25		121.55
MFI0250080	25	80	1/8"	M22x1.5	M10x1.25		123.70
MFI0250100	25	100	1/8"	M22x1.5	M10x1.25		125.10
MFI0250125	25	125	1/8"	M22x1.5	M10x1.25		126.90
MFI0250160	25	160	1/8"	M22x1.5	M10x1.25		130.40
MFI0250200	25	200	1/8"	M22x1.5	M10x1.25		133.25
MFI0250250	25	250	1/8"	M22x1.5	M10x1.25		136.80
MFI0250320	25	320	1/8"	M22x1.5	M10x1.25		141.90

ISO 6432 RVS bevestigingen



Type MFLI - flensbevestiging

6710		€
MFLI016	16	10.65
MFLI020	20/25	17.85



Type MPDI - bevestigingvoet

6710		€
MPDI016	16	11.40
MPDI020	20/25	20.20



Type MCCI - scharnierbevestiging

6710		€
MCCI016	16	18.65
MCCI020	20/25	25.35



Type DAI - moer voor eindkap

6710			€
DASSM16	16	M16x1.5	3.55
DASSM22	20/25	M22x1.5	4.65

Type DAI - moer voor zuigerstang

6710			€
DASSM6	16	M6x1	0.10
DASSM8	20	M8x1.25	0.35
DASSM10	25	M10x1.25	1.55

Perslucht cilinders



ISO 15552 cilinders

Medium:

Gefilterde, gesmeerde en ongesmeerde perslucht

Materiaal: Cilinderbuis: geanodiseerd aluminium

Zuigerstang: verchromd staal

Kappen: aluminium

Dichting: NBR/PU

Uitvoering:



Temperatuur:
0°C tot +80°C
(-20°C bij droge lucht)

Maximale werkdruk:
1 tot 10 bar



Tech Data
10256

Type XH - magnetisch - dubbelwerkend - instelbare buffering

6710	Ø mm	Stroke mm	Rod Thread	€	6710	Ø mm	Stroke mm	Rod Thread	€		
XH0320025	32	25	1/8"	M10x1.25	76.05	XH0500200	50	200	1/4"	M16x1.5	127.20
XH0320050	32	50	1/8"	M10x1.25	78.05	XH0500250	50	250	1/4"	M16x1.5	134.95
XH0320075	32	75	1/8"	M10x1.25	80.15	XH0500300	50	300	1/4"	M16x1.5	142.60
XH0320080	32	80	1/8"	M10x1.25	80.50	XH0500320	50	320	1/4"	M16x1.5	145.40
XH0320100	32	100	1/8"	M10x1.25	82.60	XH0500350	50	350	1/4"	M16x1.5	150.00
XH0320125	32	125	1/8"	M10x1.25	84.65	XH0500400	50	400	1/4"	M16x1.5	157.70
XH0320150	32	150	1/8"	M10x1.25	86.75	XH0500450	50	450	1/4"	M16x1.5	165.40
XH0320160	32	160	1/8"	M10x1.25	87.60	XH0500500	50	500	1/4"	M16x1.5	173.15
XH0320200	32	200	1/8"	M10x1.25	90.75	XH0500600	50	600	1/4"	M16x1.5	188.70
XH0320250	32	250	1/8"	M10x1.25	94.20	XH0500700	50	700	1/4"	M16x1.5	204.40
XH0320300	32	300	1/8"	M10x1.25	98.60	XH0500800	50	800	1/4"	M16x1.5	220.00
XH0320320	32	320	1/8"	M10x1.25	100.40	XH0500900	50	900	1/4"	M16x1.5	235.70
XH0320350	32	350	1/8"	M10x1.25	103.05	XH0501000	50	1000	1/4"	M16x1.5	251.00
XH0320400	32	400	1/8"	M10x1.25	107.45	XH0630025	63	25	3/8"	M16x1.5	122.75
XH0320450	32	450	1/8"	M10x1.25	113.30	XH0630050	63	50	3/8"	M16x1.5	126.25
XH0320500	32	500	1/8"	M10x1.25	118.40	XH0630075	63	75	3/8"	M16x1.5	129.80
XH0320600	32	600	1/8"	M10x1.25	128.45	XH0630080	63	80	3/8"	M16x1.5	130.50
XH0320700	32	700	1/8"	M10x1.25	138.60	XH0630100	63	100	3/8"	M16x1.5	133.30
XH0320800	32	800	1/8"	M10x1.25	148.70	XH0630125	63	125	3/8"	M16x1.5	139.05
XH0320900	32	900	1/8"	M10x1.25	158.85	XH0630150	63	150	3/8"	M16x1.5	143.35
XH0321000	32	1000	1/8"	M10x1.25	168.65	XH0630160	63	160	3/8"	M16x1.5	145.10
XH0400025	40	25	1/4"	M12x1.25	86.60	XH0630200	63	200	3/8"	M16x1.5	151.10
XH0400050	40	50	1/4"	M12x1.25	89.15	XH0630250	63	250	3/8"	M16x1.5	159.65
XH0400075	40	75	1/4"	M12x1.25	91.70	XH0630300	63	300	3/8"	M16x1.5	168.25
XH0400080	40	80	1/4"	M12x1.25	92.20	XH0630320	63	320	3/8"	M16x1.5	171.45
XH0400100	40	100	1/4"	M12x1.25	94.25	XH0630350	63	350	3/8"	M16x1.5	176.75
XH0400125	40	125	1/4"	M12x1.25	96.85	XH0630400	63	400	3/8"	M16x1.5	185.35
XH0400150	40	150	1/4"	M12x1.25	99.35	XH0630450	63	450	3/8"	M16x1.5	193.90
XH0400160	40	160	1/4"	M12x1.25	100.35	XH0630500	63	500	3/8"	M16x1.5	202.50
XH0400200	40	200	1/4"	M12x1.25	104.35	XH0630600	63	600	3/8"	M16x1.5	219.45
XH0400250	40	250	1/4"	M12x1.25	109.45	XH0630700	63	700	3/8"	M16x1.5	236.50
XH0400300	40	300	1/4"	M12x1.25	116.05	XH0630800	63	800	3/8"	M16x1.5	253.60
XH0400320	40	320	1/4"	M12x1.25	118.65	XH0630900	63	900	3/8"	M16x1.5	270.70
XH0400350	40	350	1/4"	M12x1.25	122.25	XH0631000	63	1000	3/8"	M16x1.5	287.25
XH0400400	40	400	1/4"	M12x1.25	128.50	XH0800025	80	25	3/8"	M20x1.5	157.40
XH0400450	40	450	1/4"	M12x1.25	134.75	XH0800050	80	50	3/8"	M20x1.5	162.30
XH0400500	40	500	1/4"	M12x1.25	141.05	XH0800075	80	75	3/8"	M20x1.5	167.25
XH0400600	40	600	1/4"	M12x1.25	153.70	XH0800080	80	80	3/8"	M20x1.5	168.25
XH0400700	40	700	1/4"	M12x1.25	166.60	XH0800100	80	100	3/8"	M20x1.5	173.15
XH0400800	40	800	1/4"	M12x1.25	179.45	XH0800125	80	125	3/8"	M20x1.5	181.55
XH0400900	40	900	1/4"	M12x1.25	192.35	XH0800150	80	150	3/8"	M20x1.5	187.85
XH0401000	40	1000	1/4"	M12x1.25	204.90	XH0800160	80	160	3/8"	M20x1.5	190.35
XH0500025	50	25	1/4"	M16x1.5	103.20	XH0800200	80	200	3/8"	M20x1.5	200.45
XH0500050	50	50	1/4"	M16x1.5	106.55	XH0800250	80	250	3/8"	M20x1.5	213.20
XH0500075	50	75	1/4"	M16x1.5	109.90	XH0800300	80	300	3/8"	M20x1.5	225.90
XH0500080	50	80	1/4"	M16x1.5	110.55	XH0800320	80	320	3/8"	M20x1.5	230.80
XH0500100	50	100	1/4"	M16x1.5	113.20	XH0800350	80	350	3/8"	M20x1.5	238.65
XH0500125	50	125	1/4"	M16x1.5	116.55	XH0800400	80	400	3/8"	M20x1.5	251.40
XH0500150	50	150	1/4"	M16x1.5	119.95	XH0800450	80	450	3/8"	M20x1.5	264.15
XH0500160	50	160	1/4"	M16x1.5	121.20	XH0800500	80	500	3/8"	M20x1.5	276.95

ISO 15552 cilinders

Medium:

Gefilterde, gesmeerde en ongesmeerde perslucht

Materiaal: Cilinderbuis: geanodiseerd aluminium

Zuigerstang: verchromd staal

Kappen: aluminium

Dichting: NBR/PU

Uitvoering:



Temperatuur:
0°C tot +80°C
(-20°C bij droge lucht)

Maximale werkdruk:
1 tot 10 bar



Tech Data
10256

Type XH - magnetisch - dubbelwerkend - instelbare buffering

6710					€
XH0800600	80	600	3/8"	M20x1.5	302.20
XH0800700	80	700	3/8"	M20x1.5	327.60
XH0800800	80	800	3/8"	M20x1.5	353.00
XH0800900	80	900	3/8"	M20x1.5	378.45
XH0801000	80	1000	3/8"	M20x1.5	403.30
XH1000025	100	25	1/2"	M20x1.5	188.70
XH1000050	100	50	1/2"	M20x1.5	194.60
XH1000075	100	75	1/2"	M20x1.5	200.50
XH1000080	100	80	1/2"	M20x1.5	201.65
XH1000100	100	100	1/2"	M20x1.5	207.60
XH1000125	100	125	1/2"	M20x1.5	213.45
XH1000150	100	150	1/2"	M20x1.5	219.35
XH1000160	100	160	1/2"	M20x1.5	221.75
XH1000200	100	200	1/2"	M20x1.5	231.45
XH1000250	100	250	1/2"	M20x1.5	243.80
XH1000300	100	300	1/2"	M20x1.5	256.15
XH1000320	100	320	1/2"	M20x1.5	261.00
XH1000350	100	350	1/2"	M20x1.5	268.50
XH1000400	100	400	1/2"	M20x1.5	280.80
XH1000450	100	450	1/2"	M20x1.5	293.20
XH1000500	100	500	1/2"	M20x1.5	306.20
XH1000600	100	600	1/2"	M20x1.5	331.45
XH1000700	100	700	1/2"	M20x1.5	356.70
XH1000800	100	800	1/2"	M20x1.5	381.95
XH1000900	100	900	1/2"	M20x1.5	407.20
XH1001000	100	1000	1/2"	M20x1.5	432.35
XH1250025	125	25	1/2"	M27x2	299.80
XH1250050	125	50	1/2"	M27x2	307.10
XH1250075	125	75	1/2"	M27x2	314.45
XH1250080	125	80	1/2"	M27x2	315.80
XH1250100	125	100	1/2"	M27x2	321.90
XH1250125	125	125	1/2"	M27x2	329.25
XH1250150	125	150	1/2"	M27x2	336.55
XH1250160	125	160	1/2"	M27x2	339.65
XH1250200	125	200	1/2"	M27x2	352.00
XH1250250	125	250	1/2"	M27x2	367.65
XH1250300	125	300	1/2"	M27x2	383.40
XH1250320	125	320	1/2"	M27x2	389.85
XH1250350	125	350	1/2"	M27x2	399.05
XH1250400	125	400	1/2"	M27x2	415.90
XH1250450	125	450	1/2"	M27x2	433.45
XH1250500	125	500	1/2"	M27x2	450.95
XH1250600	125	600	1/2"	M27x2	486.25
XH1250700	125	700	1/2"	M27x2	521.55
XH1250800	125	800	1/2"	M27x2	556.75
XH1250900	125	900	1/2"	M27x2	592.05
XH1251000	125	1000	1/2"	M27x2	626.90

Type XB - magnetisch - enkelwerkend

6710					€
XB0320025	32	25	1/8"	M10x1.25	98.80
XB0320050	32	50	1/8"	M10x1.25	101.45
XB0320075	32	75	1/8"	M10x1.25	104.20
XB0320080	32	80	1/8"	M10x1.25	104.65
XB0320100	32	100	1/8"	M10x1.25	107.30
XB0400025	40	25	1/4"	M12x1.25	112.65
XB0400050	40	50	1/4"	M12x1.25	115.85
XB0400075	40	75	1/4"	M12x1.25	119.20
XB0400080	40	80	1/4"	M12x1.25	119.85
XB0400100	40	100	1/4"	M12x1.25	122.55
XB0500025	50	25	1/4"	M16x1.5	134.10
XB0500050	50	50	1/4"	M16x1.5	138.40
XB0500075	50	75	1/4"	M16x1.5	142.85
XB0500080	50	80	1/4"	M16x1.5	143.75
XB0500100	50	100	1/4"	M16x1.5	147.15
XB0630025	63	25	3/8"	M16x1.5	159.55
XB0630050	63	50	3/8"	M16x1.5	164.20
XB0630075	63	75	3/8"	M16x1.5	168.75
XB0630080	63	80	3/8"	M16x1.5	169.65
XB0630100	63	100	3/8"	M16x1.5	173.35
XB0800025	80	25	3/8"	M20x1.5	204.65
XB0800050	80	50	3/8"	M20x1.5	211.00
XB0800075	80	75	3/8"	M20x1.5	217.45
XB0800080	80	80	3/8"	M20x1.5	218.70
XB0800100	80	100	3/8"	M20x1.5	225.10
XB1000025	100	25	1/2"	M20x1.5	245.30
XB1000050	100	50	1/2"	M20x1.5	252.95
XB1000075	100	75	1/2"	M20x1.5	260.65
XB1000080	100	80	1/2"	M20x1.5	262.15
XB1000100	100	100	1/2"	M20x1.5	269.80

ISO 15552 bevestigingen



Type VFL - flensbevestiging

6710	Ø mm	€
VFL032	32	22.45
VFL040	40	27.60
VFL050	50	30.05
VFL063	63	40.30
VFL080	80	52.40
VFL100	100	62.70
VFL125	125	151.75



Type VCP - bevestigingsvoet

6710	Ø mm	€
VCP032	32	8.30
VCP040	40	9.60
VCP050	50	11.70
VCP063	63	12.95
VCP080	80	18.80
VCP100	100	27.65
VCP125	125	111.15



Type VCF - dubbel achterscharnier - zelfsmrend

6710	Ø mm	€
VCF032	32	18.40
VCF040	40	21.05
VCF050	50	23.40
VCF063	63	29.10
VCF080	80	36.45
VCF100	100	50.95
VCF125	125	101.00

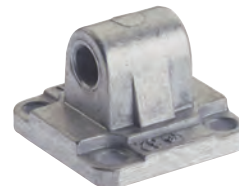

Type VCM - enkel achterscharnier

6710	Ø mm	€
VCM032	32	17.40
VCM040	40	19.00
VCM050	50	21.20
VCM063	63	26.40
VCM080	80	32.85
VCM100	100	45.80
VCM125	125	79.35



Type VCH - dubbel achterscharnier

6710	Ø mm	€
VCH032	32	15.60
VCH040	40	16.90
VCH050	50	19.85
VCH063	63	24.35
VCH080	80	31.10
VCH100	100	43.35
VCH125	125	75.80



Type VCNT - zwenktapebevestiging voor

6710	Ø mm	€
VCNT032	32	57.20
VCNT040	40	62.65
VCNT050	50	72.90
VCNT063	63	97.45
VCNT080	80	112.35
VCNT100	100	156.30
VCNT125	125	269.95

ISO 15552 bevestigingen



Type VSI - zwenktapesteun

6710	Ø mm	€
VSI032	32	52.40
VSI040	40/50	54.75
VSI063	63/80	62.45
VSI100	100/125	68.70



Type VAS - bevestigingssteun achter

6710	Ø mm	€
VAS032	32	16.75
VAS040	40	23.40
VAS050	50	25.05
VAS063	63	35.90
VAS080	80	37.55
VAS100	100	60.15
VAS125	125	69.70



Type VPE - pen

6710	Ø mm	€
VPE032	32	2.90
VPE040	40	4.05
VPE050	50	4.20
VPE063	63	4.65
VPE080	80	5.20
VPE100	100	7.65
VPE125	125	6.60



Type FC - zuigerstang gaffel met pen

6710	Ø mm		€
FC025	25/32	M10x1.25	4.15
FC040	40	M12x1.25	6.75
FC050	50/63	M16x1.5	13.85
FC080	80/100	M20x1.5	25.10
FC125	125	M27x2	89.10



Type TF - kogelstangkop - zelfsmrend

6710	Ø mm		€
TF025	25/32	M10x1.25	18.85
TF040	40	M12x1.25	28.00
TF050	50/63	M16x1.5	45.45
TF080	80/100	M20x1.5	77.20
TF125	125	M27x2	213.05



Type TS - uitlijnkop

6710	Ø mm		€
TS025	25/32	M10x1.25	48.90
TS040	40	M12x1.25	58.85
TS050	50/63	M16x1.5	78.80
TS080	80/100	M20x1.5	112.55



Type DA - moer voor zuigerstang

6710	Ø mm		€
DAM10	25/32	M10x1.25	0.25
DAM12	40	M12x1.25	0.75
DAM16	50/63	M16x1.5	0.90
DAM20	80/100	M20x1.5	1.65
DAM27	125	M27x2	3.00

Compactcilinders bevestigingen



Type QFL - flensbevestiging

6710	Ø mm	€
QFL012	12/16	17.40
QFL020	20	18.95
QFL025	25	19.85
QFL032	32	22.85
QFL040	40	26.00
QFL050	50	29.35
QFL063	63	40.60
QFL080	80	53.45
QFL100	100	62.05



Type QCP - bevestigingsvoet

6710	Ø mm	€
QCP012	12/16	5.45
QCP020	20	6.20
QCP025	25	6.20
QCP032	32	7.60
QCP040	40	8.95
QCP050	50	10.65
QCP063	63	12.90
QCP080	80	18.05
QCP100	100	23.60



Type QCM - enkel achterscharnier - zelfsmrend

6710	Ø mm	€
QCM012	12/16	15.35
QCM020	20	16.60
QCM025	25	17.95



Type QCF - dubbel achterscharnier - zelfsmrend

6710	Ø mm	€
QCF032	32	23.40
QCF040	40	26.85
QCF050	50	29.35
QCF063	63	35.50
QCF080	80	44.70
QCF100	100	62.45



Type VAS - bevestigingssteun achter

6710	Ø mm	€
VAS032	32	16.75
VAS040	40	23.40
VAS050	50	25.05
VAS063	63	35.90
VAS080	80	37.55
VAS100	100	60.15



Type VPE - pen

6710	Ø mm	€
VPE032	32	2.90
VPE040	40	4.05
VPE050	50	4.20
VPE063	63	4.65
VPE080	80	5.20
VPE100	100	7.65



Type TM - kogelstangkop male

6710	Ø mm	€	
TM020	20/25	M5x0.8	19.35
TM032	32/40	M6x1	18.40
TM050	50/63	M8x1.25	21.05
TM080	80	M10x1.5	23.70
TM100	100	M12x1.75	27.25

Magneetschakelaars

Geschikt voor gebruik met Aignep ISO 6432 rondcilinders, ISO 15552 cilinders en compactcilinders.

Temperatuur:
-20°C tot +70°C

Tech Data
10259

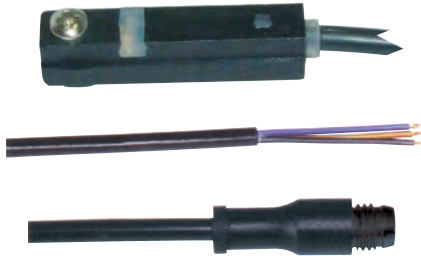

Type DSL - profielbevestiging (lengterichting)

6710					€
DSL1C225	Reed	3-130V AC/DC	2.5M	kabel (2-draads)	27.40
DSL1M8	Reed	3-130V AC/DC	0.3M	M8	31.15
DSL4N225	Hall/PNP	10/30V AC/DC	2.5M	kabel (3-draads)	41.45
DSL4M8	Hall/PNP	10/30V AC/DC	0.3M	M8	39.60



Type MFX - montagebeugel voor ISO 6432 rondcilinders

6710		€
MFX008	8	2.55
MFX010	10	2.55
MFX012	12	2.55
MFX016	16	2.55
MFX020	20	2.55
MFX025	25	2.55

Type PX - verlengkabel

6710		€
PX3000	3M	13.40
PX5000	5M	16.75

KELM™
pneumatiek

Hydrauliek

Snel-
koppelingen

Afsluiters

Roestvast
staal

Fittingen

Lucht-
conditionering

Gereedschap

Pneumatiek

Diversen

Malleabele
fittingen
& staal

Ringleiding-
systemen

Slangen

Compressoren

Flowregelaars

Flowregelaars met geïntegreerde functie

Geschikt voor perslucht, overdruk en vacuüm.

Toepassing: Flowregelaars worden op cilinders of ventielen gebouwd om de snelheid van de slag van de cilinder (uitgaand, ingaand of beide) goed in te regelen. Flowregelaars worden als smoorregeling toegepast. Het beste resultaat wordt verkregen door de uitgaande luchtstroom te smoren, waardoor schokkend werken van de cilinder wordt voorkomen.

Temperatuur:
-20°C tot 80°C

Maximale werkdruk:
1 tot 10 bar *

*** Attentie:** De drukgegevens zijn gebaseerd op een temperatuur van 20°C. Veiligheidsfactor = 3
Bij temperatuurverhoging daalt de werkdruk met een variabele factor, zie tabel PA.
Voor correcte werking is minimaal een druk nodig van 1 Bar

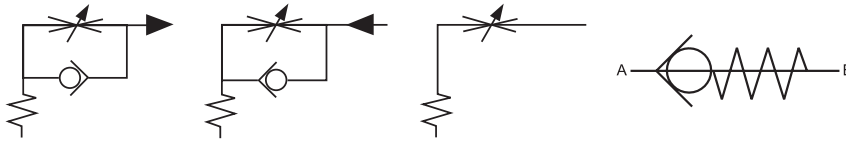

Flowregelaar - afvoer

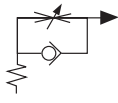

Enriching - verzonken regelschroef

MRK				€
90090500	M5	8	24	8.90
90091000	1/8"	14	30.5	6.55
90091300	1/4"	17	36	7.20

Flowregelaar - toevoer

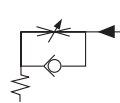

Enriching - verzonken regelschroef

MRK				€
90110500	M5	8	24	8.90
90111000	1/8"	14	30.5	6.55
90111300	1/4"	17	35.5	7.20

Flowregelaar - bidirectioneel

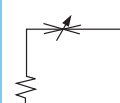

Tweerichting - verzonken regelschroef

MRK				€
90120500	M5	8	24	6.70
90121000	1/8"	14	30.5	4.90
90121300	1/4"	17	35.5	5.55

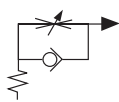

Enriching - uitwendige regelschroef

MRK				€
90350500	M5	8	35	10.00
90351000	1/8"	14	45	7.20
90351300	1/4"	17	51.5	8.10

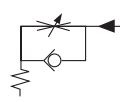

Enriching - uitwendige regelschroef

MRK				€
90360500	M5	8	35	10.00
90361000	1/8"	14	45	7.20
90361300	1/4"	17	51.5	8.25

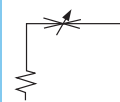

Tweerichting - uitwendige regelschroef

MRK				€
90370500	M5	8	35	7.35
90371000	1/8"	14	45	5.90
90371300	1/4"	17	51.5	6.25

Flowregelaar - terugslagklep



Niet instelbaar - stroomrichting van bout naar huis

MRK			H mm	€
90381000	1/8"	14	32.5	10.65
90381300	1/4"	17	35	11.05



Niet instelbaar - stroomrichting van huis naar bout

MRK			H mm	€
90391000	1/8"	14	32.5	10.65
90391300	1/4"	17	35	11.65

Flowregelaar opsteek - afvoer

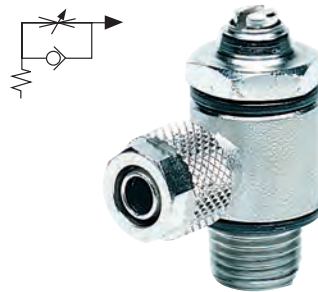

Eenrichting - verzonken regelschroef

MRK			H mm	€
90020405	4 x M5	8	24	11.20
90020410	4 x 1/8"	14	30.5	9.05
90020605	6 x M5	8	26	11.05
90020610	6 x 1/8"	14	31	9.25
90020613	6 x 1/4"	17	36	10.00
90020810	8 x 1/8"	14	31	9.25
90020813	8 x 1/4"	17	36	10.10
90021013	10 x 1/4"	17	36	9.85



Eenrichting - uitwendige regelschroef

MRK			H mm	€
91020405	4 x M5	8	35	11.65
91020410	4 x 1/8"	14	45	9.40
91020605	6 x M5	8	35	11.65
91020610	6 x 1/8"	14	45	9.50
91020613	6 x 1/4"	17	52	10.50
91020810	8 x 1/8"	14	45	9.50
91020813	8 x 1/4"	17	52	10.60
91021013	10 x 1/4"	17	52	10.70

Flowregelaar opsteek (POM) - afvoer

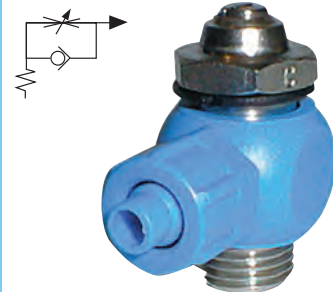

Eenrichting - verzonken regelschroef

MRK			H mm	€
90040610	6 x 1/8"	14	31	7.80
90040613	6 x 1/4"	17	36	8.50
90040810	8 x 1/8"	14	31	7.80
90040813	8 x 1/4"	17	36	8.55

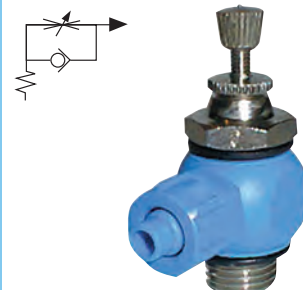

Eenrichting - uitwendige regelschroef

MRK			H mm	€
91040610	6 x 1/8"	14	45	8.35
91040613	6 x 1/4"	17	52	9.50
91040810	8 x 1/8"	14	45	8.35
91040813	8 x 1/4"	17	52	9.50



Voor



opsteekkoppelingen
zie hoofdstuk 6

KELM™
pneumatiek

Hydrauliek

Snelkoppelingen

Afsluiters

Roestvast
staal

Fittingen

Lucht-
conditionering

Gereedschap

Pneumatiek

Diversen

Malleabele
fittingen
& staal

Ringleiding-
systemen

Slangen

Compressoren

Flowregelaars



Flowregelaar push-in - afvoer

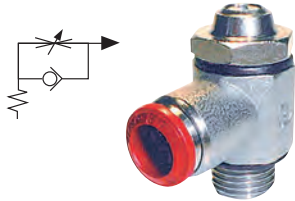

Enriching - verzonken regelschroef

MRK				€
90090405	4 x M5	8	24	11.65
90090410	4 x 1/8"	14	31	9.40
90090610	6 x 1/8"	14	31	9.50
90090613	6 x 1/4"	17	36	10.40
90090810	8 x 1/8"	14	31	9.85
90090813	8 x 1/4"	17	36	10.60
90091013	10 x 1/4"	17	36	10.95

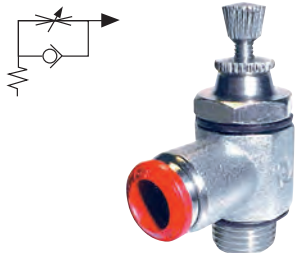

Enriching - uitwendige regelschroef

MRK				€
91090405	4 x M5	8	35	12.90
91090410	4 x 1/8"	14	45	10.05
91090610	6 x 1/8"	14	45	10.15
91090613	6 x 1/4"	17	52	11.30
91090810	8 x 1/8"	14	45	10.50
91090813	8 x 1/4"	17	52	11.45
91091013	10 x 1/4"	17	52	11.95

Compacte flowregelaar push-in - afvoer

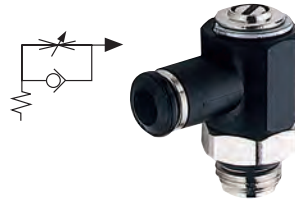

Enriching - verzonken regelschroef - kort conisch draad met seal

MRK				€
90160405	4 x M5	8	24	13.45
90160410	4 x 1/8"	14	30.5	10.80
90160605	6 x M5	8	24	13.50
90160610	6 x 1/8"	14	30.5	10.80
90160613	6 x 1/4"	17	36	11.65
90160810	8 x 1/8"	14	30.5	10.80
90160813	8 x 1/4"	17	36	11.65

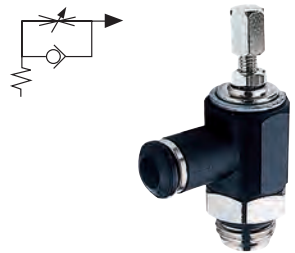

Enriching - uitwendige regelschroef - kort conisch draad met seal

MRK				€
90170405	4 x M5	8	37.5	13.75
90170410	4 x 1/8"	14	46.5	10.95
90170605	6 x M5	8	37.5	13.75
90170610	6 x 1/8"	14	46.5	10.95
90170613	6 x 1/4"	17	53	11.95
90170810	8 x 1/8"	14	46.5	10.95
90170813	8 x 1/4"	17	53	11.95

Flowregelaar push-in - afvoer



Enriching - uitwendige regelschroef en borgmoer

INLB		€
33310405N	4 x M5	6.70
33310413N	4 x 1/4"	8.00
33310410N	4 x 1/8"	8.15
33310605N	6 x M5	7.20
33310610N	6 x 1/8"	8.25
33310613N	6 x 1/4"	8.50
33310617N	6 x 3/8"	10.65
33310810N	8 x 1/8"	8.70
33310813N	8 x 1/4"	8.90
33310817N	8 x 3/8"	10.65
33311013N	10 x 1/4"	11.05
33311017N	10 x 3/8"	11.05
33311021N	10 x 1/2"	15.90
33311213N	12 x 1/4"	14.80
33311217N	12 x 3/8"	16.00
33311221N	12 x 1/2"	16.10

Inline flowregelaar push-in - afvoer

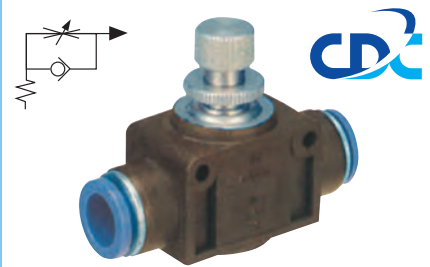

Enriching - uitwendige regelschroef en borgmoer

INLB		€
33300400N	4	8.90
33300600N	6	10.30
33300800N	8	11.85
33301000N	10	13.20
33301200N	12	14.85

Flowregelaar BSP female - afvoer

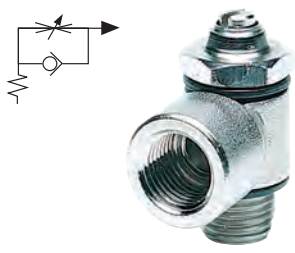

Enriching - verzonken regelschroef

MRK				€
90111010	1/8"	14	31	8.55
90111313	1/4"	17	36	9.50

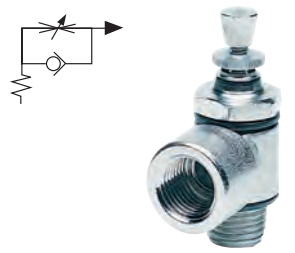

Enriching - uitwendige regelschroef

MRK				€
91111010	1/8"	14	35	9.15
91111313	1/4"	17	45	10.50

KELM™
pneumatiek

Hydrauliek

Snel-
koppelingen

Afsluiters

Roestvast
staal

Fittingen

Lucht-
conditionering

Gereedschap

Pneumatiek

Diversen

Malleabele
fittingen &
staal

Ringleiding-
systemen

Slangen

Compressoren

Flowregelaar opsteek - toevoer

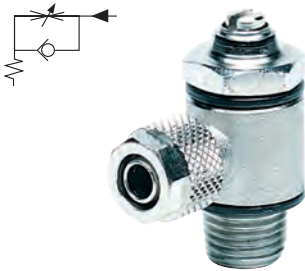

Enriching - verzonken regelschroef

MRK					€
90010405	4 x M5	8	24		10.60
90010410	4 x 1/8"	14	30.5		8.65
90010605	6 x M5	8	26		10.60
90010610	6 x 1/8"	14	31		8.85
90010613	6 x 1/4"	17	36		9.50
90010810	8 x 1/8"	14	31		8.85
90010813	8 x 1/4"	17	36		9.75
90011013	10 x 1/4"	17	36		9.85

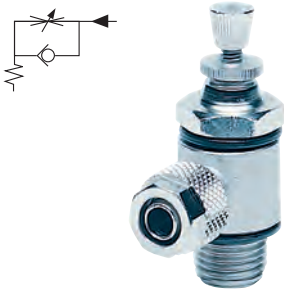

Enriching - uitwendige regelschroef

MRK					€
91010405	4 x M5	8	35		11.65
91010410	4 x 1/8"	14	45		9.40
91010605	6 x M5	8	35		11.90
91010610	6 x 1/8"	14	45		9.50
91010613	6 x 1/4"	17	52		10.70
91010810	8 x 1/8"	14	45		9.50
91010813	8 x 1/4"	17	52		10.70
91011013	10 x 1/4"	17	52		10.95

Flowregelaar opsteek (POM) - toevoer

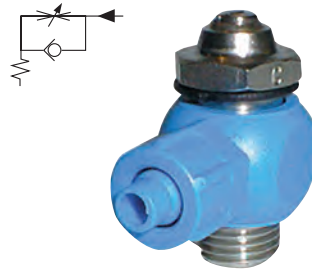

Enriching - verzonken regelschroef

MRK					€
90030610	6 x 1/8"	14	31		7.80
90030613	6 x 1/4"	17	36		8.50
90030810	8 x 1/8"	14	31		7.80
90030813	8 x 1/4"	17	36		8.50

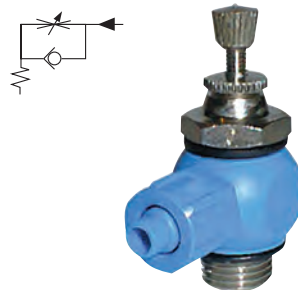

Enriching - uitwendige regelschroef

MRK					€
91030610	6 x 1/8"	14	45		8.35
91030613	6 x 1/4"	17	52		9.75
91030810	8 x 1/8"	14	45		8.35
91030813	8 x 1/4"	17	52		9.75

Flowregelaar push-in - toevoer

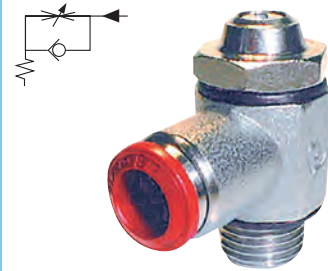

Enriching - verzonken regelschroef

MRK					€
90070405	4 x M5	8	24		11.65
90070410	4 x 1/8"	14	31		9.40
90070610	6 x 1/8"	14	31		9.50
90070613	6 x 1/4"	17	36		10.40
90070810	8 x 1/8"	14	31		9.85
90070813	8 x 1/4"	17	36		10.60
90071013	10 x 1/4"	17	36		10.95

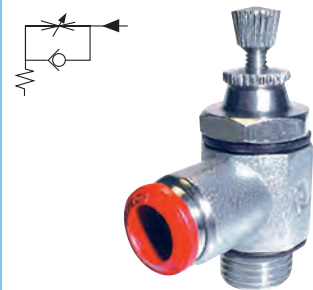

Enriching - uitwendige regelschroef

MRK					€
91070405	4 x M5	8	35		12.90
91070410	4 x 1/8"	14	45		10.05
91070610	6 x 1/8"	14	45		10.15
91070613	6 x 1/4"	17	52		11.35
91070810	8 x 1/8"	14	45		10.50
91070813	8 x 1/4"	17	52		11.65
91071013	10 x 1/4"	17	52		12.05

KELM™
pneumatiek

Hydrauliek

Snel-
koppelingen

Afsluiters

Roestvast
staal

Fittingen

Lucht-
conditionering

Gereedschap

Pneumatiek

Diversen

Malleabele
fittingen
& staal

Ringleiding-
systemen

Slangen

Compressoren

Compacte flowregelaar push-in - toevoer

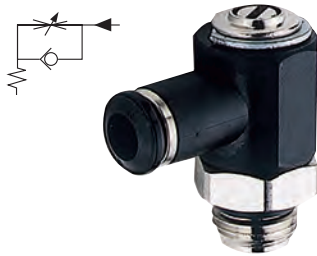

Eenrichting - verzonken regelschroef - kort conisch draad met seal

MRK				€
90180405	4 x M5	8	24	13.45
90180410	4 x 1/8"	14	30.5	10.80
90180605	6 x M5	8	24	13.45
90180610	6 x 1/8"	14	30.5	10.80
90180613	6 x 1/4"	17	36	11.65
90180810	8 x 1/8"	14	30.5	10.80
90180813	8 x 1/4"	17	36	11.55

Flowregelaar BSP female - toevoer

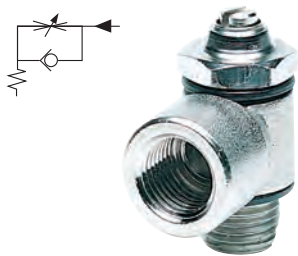

Eenrichting - verzonken regelschroef

MRK				€
90101010	1/8"	14	31	8.55
90101313	1/4"	17	36	9.50

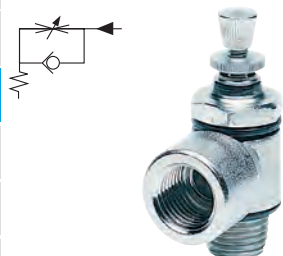

Eenrichting - uitwendige regelschroef

MRK				€
91101010	1/8"	14	35	9.15
91101313	1/4"	17	45	10.70

Flowregelaar opsteek - bidirectioneel



Tweerichting - verzonken regelschroef

MRK				€
90120405	4 x M5	8	24	8.25
90120410	4 x 1/8"	14	31	6.95
90120605	6 x M5	8	26	8.30
90120610	6 x 1/8"	14	31	7.05
90120613	6 x 1/4"	17	36	7.80
90120810	8 x 1/8"	14	31	7.10
90120813	8 x 1/4"	17	36	7.95
90121013	10 x 1/4"	17	36	8.05

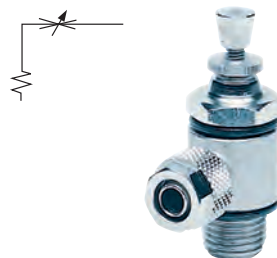

Tweerichting - uitwendige regelschroef

MRK				€
91120405	4 x M5	8	35	9.00
91120410	4 x 1/8"	14	45	7.95
91120605	6 x M5	8	43	9.00
91120610	6 x 1/8"	14	45	8.05
91120613	6 x 1/4"	17	52	8.55
91120810	8 x 1/8"	14	45	8.15
91120813	8 x 1/4"	17	52	8.65
91121013	10 x 1/4"	17	52	8.85

Flowregelaar push-in - bidirectioneel

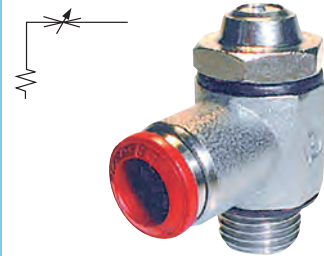

Tweerichting - verzonken regelschroef

MRK				€
90130405	4 x M5	8	24	9.40
90130410	4 x 1/8"	14	31	7.60
90130610	6 x 1/8"	14	31	7.80
90130613	6 x 1/4"	17	36	8.55
90130810	8 x 1/8"	14	31	8.05
90130813	8 x 1/4"	17	36	8.85
90131013	10 x 1/4"	17	36	9.15

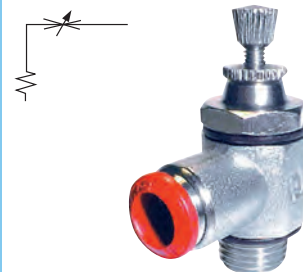

Tweerichting - uitwendige regelschroef

MRK				€
91130405	4 x M5	8	35	10.05
91130410	4 x 1/8"	14	45	8.55
91130610	6 x 1/8"	14	45	8.65
91130613	6 x 1/4"	17	52	9.40
91130810	8 x 1/8"	14	45	9.00
91130813	8 x 1/4"	17	52	9.75
91131013	10 x 1/4"	17	52	10.05

Voor push-in koppelingen zie hoofdstuk 6



Flowregelaars

Flowregelaar BSP female - bidirectioneel



Tweerichting - verzonken regelschroef

MRK	BSPP		H mm	€
90141010	1/8"	14	31	6.70
90141313	1/4"	17	36	7.80



Tweerichting - uitwendige regelschroef

MRK	BSPP		H mm	€
91141010	1/8"	14	35	8.85
91141313	1/4"	17	45	10.00

Compacte flowregelaar push-in - bidirectioneel



Tweerichting - verzonken regelschroef - kort conisch draad met seal

MRK			H mm	€
90200405	4 x M5	8	24	13.45
90200410	4 x 1/8"	14	30.5	10.80
90200605	6 x M5	8	24	13.45
90200610	6 x 1/8"	14	30.5	10.80
90200613	6 x 1/4"	17	36	11.65
90200810	8 x 1/8"	14	30.5	10.80
90200813	8 x 1/4"	17	36	11.65

Inline flowregelaar BSP female

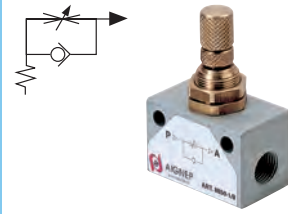

Eenrichting - uitwendige regelschroef

MRK			H mm	€
90050505	M5	12	26	9.90
90051010	1/8"	15	35	9.40
90051313	1/4"	15	46	12.65
90051717	3/8"	22	50	24.05
90052121	1/2"	22	60	26.20



Tweerichting - uitwendige regelschroef

MRK			H mm	€
90060505	M5	12	26	9.90
90061010	1/8"	15	35	9.40
90061313	1/4"	15	46	12.65
90061717	3/8"	22	50	24.05
90062121	1/2"	22	60	26.20

Logic ventielen

Temperatuur:
-10°C tot +60°C

Maximale werkdruk:
2 tot 10 bar



Huis: geanodiseerd aluminium
Veren: RVS
Seals: NBR
Inerne delen: messing

Medium:
Perslucht

Wisselventiel (OF-ventiel)



BSP female

6690	BSPP	ND mm	€
8870-1/8	1/8"	2.5	24.70

Tweedrukventiel (EN-ventiel)



BSP female

6690	BSPP	ND mm	€
8872-1/8	1/8"	2.5	25.15

KELM™ pneumatiek

Hydrauliek

Snelkoppelingen

Afsluiters

Roestvast staal

Fittingen

Luchtconditionering

Gereedschap

Pneumatiek

Diversen

Malleabele fittingen & staal

Ringleidingssystemen

Slangen

Compressoren

Elektropneumatische ventielen



Temperatuur:
-10°C tot +60°C



Maximale werkdruk:
Monostabiel: 2 tot 10 bar
Bistabiel: 1 tot 10 bar



FLOW
1/8": 740 NI/min
1/4": 1200 NI/min



Huis: geanodiseerd aluminium
Spoel: chemisch vernikkeld
Seals: NBR

Elektropneumatische ventielen worden standaard geleverd zonder spoel en stekker. Deze zijn te vinden op pagina 581

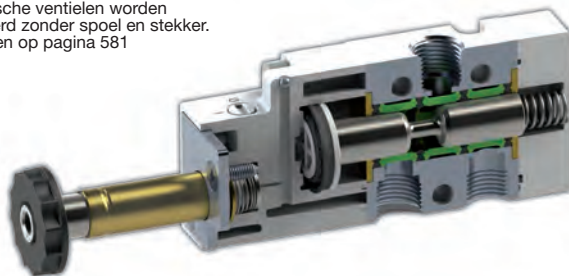

Elektropneumatische 3/2 ventielen

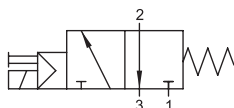

NC - monostabiel veer retour

6690



01VS03NC02	1/8"	68.95
01VS03NC03	1/4"	74.95

Elektropneumatische 5/2 ventielen

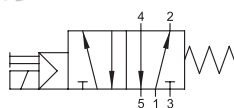
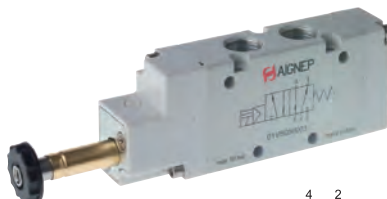

Monostabiel veer retour

6690



01VS050002	1/8"	74.30
01VS050003	1/4"	79.55

Elektropneumatische 5/3 ventielen

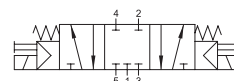

Monostabiel veer retour - CC
middenstand gesloten

6690



01VS07CC02	1/8"	121.80
01VS07CC03	1/4"	137.75

Hydrauliek

Snelkoppelingen

Afsluiters

Roestvast staal

Fittingen

Luchtconditionering

Gereedschap

Pneumatiek

Diversen

Malleabele fittingen & staal

Ringleidingssystemen

Slangen

Compressoren

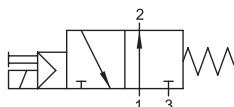

NO - monostabiel veer retour

6690



01VS03NO02	1/8"	68.95
01VS03NO03	1/4"	74.95

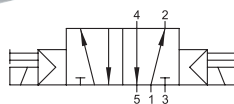

Bistabiel

6690



01VS150002	1/8"	95.30
01VS150003	1/4"	104.70

Monostabiel veer retour - OC
middenstand geopend

6690



01VS07OC02	1/8"	121.80
01VS07OC03	1/4"	137.75

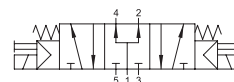

Monostabiel veer retour - PC
middenstand onder druk

6690



01VS07PC02	1/8"	121.80
01VS07PC03	1/4"	137.75

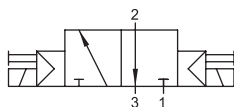

Bistabiel

6690



01VS130002	1/8"	91.65
01VS130003	1/4"	97.95

Luchtbediende ventielen

- Temperatuur:**
-10°C tot +60°C
- Maximale werkdruk:**
Monostabiel: 2 tot 10 bar
Bistabiel: 1 tot 10 bar
- FLOW**
1/8": 740 NI/min
1/4": 1200 NI/min
- Huis:** geanodiseerd aluminium
Spoel: chemisch vernikkeld
Seals: NBR

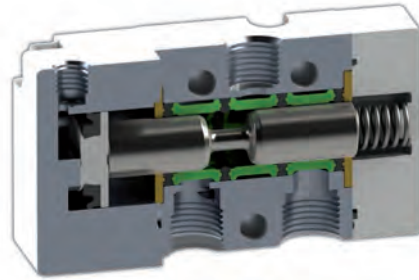

Luchtbediende 3/2 ventielen

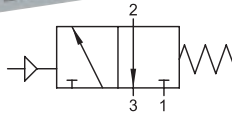

NC - monostabiel veer retour

6690		€
01VP03NC02	1/8"	52.05
01VP03NC03	1/4"	54.25

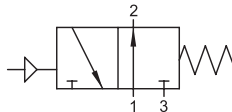

NO - monostabiel veer retour

6690		€
01VP03NO02	1/8"	52.05
01VP03NO03	1/4"	54.25

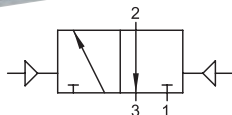

Bistabiel

6690		€
01VP130002	1/8"	59.30
01VP130003	1/4"	61.75

Luchtbediende 5/2 ventielen

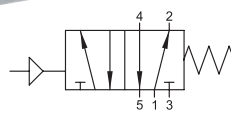

Monostabiel veer retour

6690		€
01VP050002	1/8"	58.00
01VP050003	1/4"	62.15

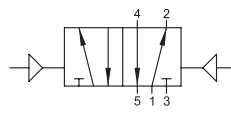

Bistabiel

6690		€
01VP150002	1/8"	67.65
01VP150003	1/4"	70.35

Luchtbediende 5/3 ventielen

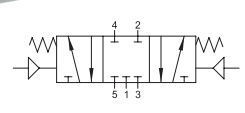

Monostabiel veer retour - CC middenstand gesloten

6690		€
01VP07CC02	1/8"	69.60
01VP07CC03	1/4"	72.00



Monostabiel veer retour - OC middenstand geopend

6690		€
01VP07OC02	1/8"	69.60
01VP07OC03	1/4"	72.00

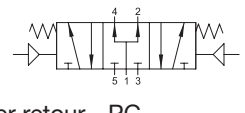

Monostabiel veer retour - PC middenstand onder druk

6690		€
01VP07PC02	1/8"	69.60
01VP07PC03	1/4"	72.00

Handbediende ventielen



Temperatuur:
-10°C tot +60°C

Maximale werkdruk:
0 tot 10 bar

FLOW
1/8": 740 NI/min
1/4": 1200 NI/min

Huis: geanodiseerd aluminium
Spoel: chemisch vernikkeld
Seals: NBR

Paneelmontage:
M16x1

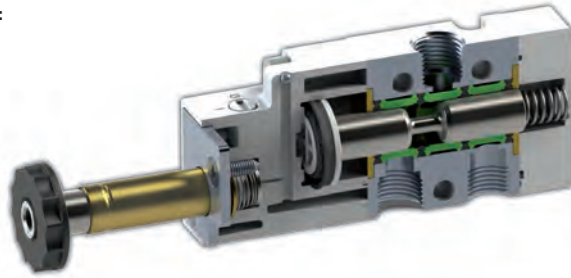

Handbediende 3/2 ventielen - trek/drukknop

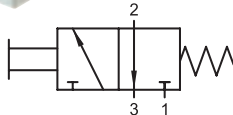

NC - monostabiel veer retour

6690		€
01VT03NC02	1/8"	54.50
01VT03NC03	1/4"	59.30

Handbediende 5/2 ventielen - trek/drukknop

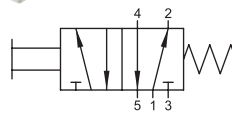

Monostabiel veer retour

6690		€
01VT050002	1/8"	63.55
01VT050003	1/4"	69.50

Handbediende 3/2 ventielen - 90° hefboom

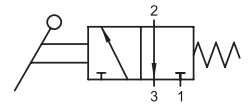

NC - monostabiel veer retour

6690		€
01VL03NC02	1/8"	63.85
01VL03NC03	1/4"	67.90

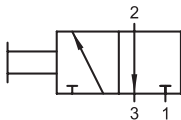

Bistabiel

6690		€
01VT130002	1/8"	54.50
01VT130003	1/4"	59.30

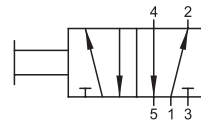

Bistabiel

6690		€
01VT150002	1/8"	63.55
01VT150003	1/4"	69.50

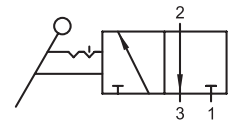

Bistabiel

6690		€
01VL130002	1/8"	66.60
01VL130003	1/4"	71.60

KELM™ pneumatiek

Hydrauliek

Snelkoppelingen

Afsluiters

Roestvast staal

Fittingen

Luchtconditionering

Gereedschap

Pneumatiek

Diversen

Malleabele fittingen & staal

Ringleidingssystemen

Slangen

Compressoren

Handbediende 5/2 ventielen - 90° hefboom

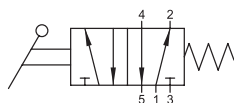

Monostabiel veer retour

6690		
01VL050002	1/8"	72.75
01VL050003	1/4"	78.55

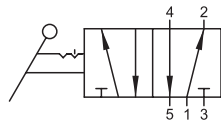

Bistabiel

6690		
01VL150002	1/8"	75.15
01VL150003	1/4"	82.00

Handbediende 5/3 ventielen - 90° hefboom

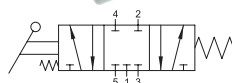

Monostabiel veer retour - CC
middenstand gesloten

6690		
01VL07CC02	1/8"	80.85
01VL07CC03	1/4"	88.00



Monostabiel veer retour - OC
middenstand geopend

6690		
01VL07OC02	1/8"	80.85
01VL07OC03	1/4"	88.00

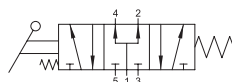

Monostabiel veer retour - PC
middenstand onder druk

6690		
01VL07PC02	1/8"	80.85
01VL07PC03	1/4"	88.00

Bistabiel - CC
middenstand gesloten

6690		
01VL27CC02	1/8"	80.85
01VL27CC03	1/4"	88.00

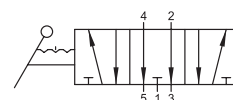

Bistabiel - OC
middenstand geopend

6690		
01VL27OC02	1/8"	80.85
01VL27OC03	1/4"	88.00

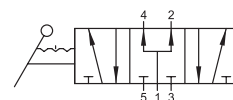

Bistabiel - PC
middenstand onder druk

6690		
01VL27PC02	1/8"	80.85
01VL27PC03	1/4"	88.00

KELM™
pneumatiek

Hydrauliek

Snel-
koppelingen

Afsluiters

Roestvast
staal

Fittingen

Lucht-
conditionering

Gereedschap

Pneumatiek

Diversen

Malleabele
fittingen
& staal

Ringleiding-
systemen

Slangen

Compressoren

Basisplaten

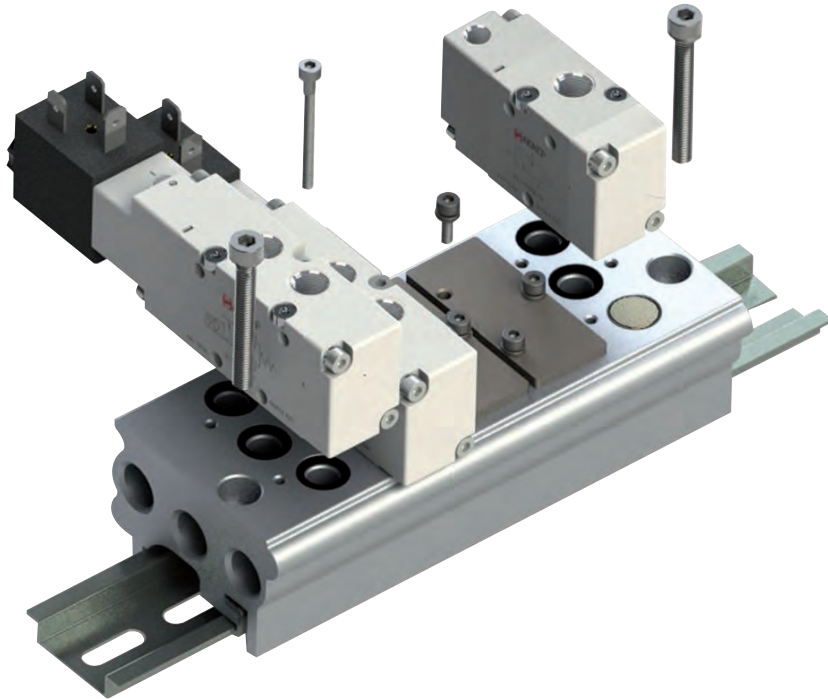

1/8" - compleet met schroeven en O-ring

6690	BSPP	No. of Stations	€
01VB000002	1/8"	2	46.45
01VB000003	1/8"	3	54.10
01VB000004	1/8"	4	61.15
01VB000005	1/8"	5	67.75
01VB000006	1/8"	6	73.65
01VB000007	1/8"	7	80.50
01VB000008	1/8"	8	87.20
01VB000009	1/8"	9	95.45
01VB000010	1/8"	10	105.30

1/4" - compleet met schroeven en O-ring

6690	BSPP	No. of Stations	€
01VB010002	1/4"	2	47.35
01VB010003	1/4"	3	55.30
01VB010004	1/4"	4	63.55
01VB010005	1/4"	5	70.15
01VB010006	1/4"	6	76.85
01VB010007	1/4"	7	83.90
01VB010008	1/4"	8	91.35
01VB010009	1/4"	9	99.60
01VB010010	1/4"	10	108.25

Accessoires basisplaten



Pluggen voor drieweg ventilaansluiting

6690	BSPP	€
01VB600000	1/8"	1.50
01VB600001	1/4"	1.70



Pluggen voor basisplaat

6690	BSPP	€
01VB800000	1/8"	1.50
01VB800001	1/4"	1.70

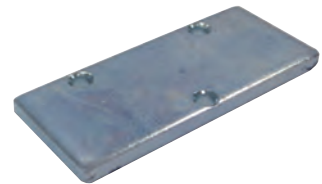

Blindplaten

6690	BSPP	€
01VB900000	1/8"	3.00
01VB900001	1/4"	3.30

KELM™
pneumatiek

Hydrauliek

Snel-
koppelingen

Afsluiters

Roesvast
staal

Fittingen

Lucht-
conditionering

Gereedschap

Pneumatiek

Diversen

Malleabele
fittingen
& staal

Ringleiding-
systemen

Slangen

Compressoren

Magneetventielen

- Temperatuur:**
-10°C tot +60°C
- Maximale werkdruk:**
0 tot 10 bar
- FLOW**
300 NI/min
- Huis:** geanodiseerd aluminium
Seals: NBR

Magneetventielen worden standaard geleverd zonder spoel en stekker.



Magneetventielen 3/2

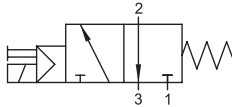

NC - met manual override

6690		
07VS03NC02	1/8"	35.60
07VS03NCX1	4mm	41.55

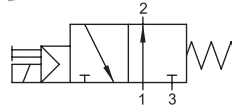

NO - met manual override

6690		
07VS03NO02	1/8"	35.60
07VS03NOX1	4mm	41.55

Spoelen en stekkers

Voltage tolerantie: ±10%
Isolatieklasse: F CEI EN 60085
IP65 IEC 60529 met stekker



Spoelen - DIN 43650 B

6690		
SOL01012C1000	12V DC 3W	10.55
SOL01024A2000	24V AC 5VA	10.55
SOL01024C1000	24V DC 3W	10.55
SOL01024C3000	24V DC 2W	10.55
SOL01110A2000	110V AC 5VA	10.55
SOL01220A2000	220V AC 5VA	10.55

Isolatieklasse: IP65 IEC 60529 met stekker
Kabeldiameter: 6-8mm



Stekkers - standaard

6690		
CON0100001	standaard A 2 pins Zwart	2.40

Isolatieklasse: IP65 IEC 60529 met stekker
Kabeldiameter: 6-8mm



Stekkers - LED

6690		
CON0202400	LED+VDR 0-24V Transparant	10.25
CON0211000	LED+VDR 110V Transparant	10.25
CON0225000	LED+VDR 220V Transparant	10.25

KELM™
pneumatiek

Hydrauliek

Snel-
koppelingen

Afsluiters

Roestvast
staal

Fittingen

Lucht-
conditionering

Gereedschap

Pneumatiek

Diversen

Malleabele
fittings
& staal

Ringleiding-
systemen

Slangen

Compressoren

Handbediende ventielen



Temperatuur:
-5°C tot 50°C
Voetbediend pneumatisch -10°C tot 50°C
Voetbediend elektrisch -25°C tot 70°C

Medium:
Gesmeerde of ongesmeerde geconditioneerde perslucht

FLOW
Serie 100: 75 l/min bij 6 bar /ΔP 1
Serie 120: 490 l/min bij 6 bar /ΔP 1
Serie 125: 800 l/min bij 6 bar /ΔP 1
Serie 140: 8mm: 75 l/min bij 6 bar /ΔP 1
Serie 140: 1/4" 550 l/min bij 6 bar /ΔP 1

mat Huis Kunststof (technopolymeer)
Delen, messing en RVS

SEAL NBR

Van alle Aircomp producten zijn op aanvraag technische tekeningen met inbouwmaten beschikbaar.

Serie 120 Ventielen met technopolymeer huis. Geschikt voor single use.
Serie 125 Ventielen met technopolymeer huis. Geschikt voor single use & battery assembly.

Serie 120 - 1/8"

Maximale werkdruk:
0 - 10 bar



Zij-Tuimelaar



Trek/Druk



Tuimelaar

3/2 handbediend ventiel - 1/8" BSP female

VEN	Funcie	Lucht	€
2038-6470	AC HB 3/2 1/8" NC DK Handbediend met Drukknop, Veerretour		1/8" 29.25
2038-6488	AC HB 3/2 1/8" DK Handbediend met Trek/Drukknop		1/8" 29.25
2038-6496	AC HB 3/2 1/8" NC TUI Handbediend met Tuimelaar, Veerretour		1/8" 35.05
2038-6504	AC HB 3/2 1/8" TUI Handbediend met Tuimelaar		1/8" 31.65
2038-6512	AC HB 3/2 1/8" NC ZTUI Handbediend met Zij-Tuimelaar, Veerretour		1/8" 36.45
2038-6520	AC HB 3/2 1/8" ZTUI Handbediend met Zij-Tuimelaar		1/8" 36.30

5/2 handbediend ventiel - 1/8" BSP female

VEN	Funcie	Lucht	€
2038-6538	AC HB 5/2 1/8" DK Veerr Handbediend met Drukknop, Veerretour		1/8" 32.60
2038-6546	AC HB 5/2 1/8" DK Handbediend met Trek/Drukknop		1/8" 32.60
2038-6595	AC HB 5/2 1/8" TUI Veerr Handbediend met Tuimelaar, Veerretour		1/8" 36.00
2038-6603	AC HB 5/2 1/8" TUI Handbediend met Tuimelaar		1/8" 34.95

5/3 handbediend ventiel - 1/8" BSP female

VEN	Funcie	Lucht	€
2038-6553	AC HB 5/3 1/8" DK Mid Gesloten RTC Handbediend met Drukknop, Return To Centre		1/8" 41.85
2038-6561	AC HB 5/3 1/8" DK Mid Geopend RTC Handbediend met Drukknop, Return To Centre		1/8" 41.85
2038-6587	AC HB 5/3 1/8" DK Mid Druk RTC Handbediend met Drukknop, Return To Centre		1/8" 41.85
2038-6611	AC HB 5/3 1/8" TUI Mid Gesloten Handbediend met Tuimelaar		1/8" 52.35
2038-6629	AC HB 5/3 1/8" TUI Mid Geopend Handbediend met Tuimelaar		1/8" 52.35
2038-6637	AC HB 5/3 1/8" TUI Mid Druk Handbediend met Tuimelaar		1/8" 52.35
2038-6645	AC HB 5/3 1/8" TUI Mid Gesl RTC Handbediend met Tuimelaar, Return To Centre		1/8" 51.95
2038-6652	AC HB 5/3 1/8" TUI Mid Geop RTC Handbediend met Tuimelaar, Return To Centre		1/8" 51.95
2038-6660	AC HB 5/3 1/8" TUI Mid Druk RTC Handbediend met Tuimelaar, Return To Centre		1/8" 51.95

5/2 handbediend ventiel - zij uitvoering - 1/8" BSP female

VEN	Funcie	Lucht	€
2038-6678	AC HB 5/2 1/8" ZTUI Veerr Handbediend met Zij-Tuimelaar, Veerretour		1/8" 40.00
2038-6686	AC HB 5/2 1/8" TUI Handbediend met Zij-Tuimelaar		1/8" 40.00

5/3 handbediend ventiel - zij uitvoering - 1/8" BSP female

VEN	Funcie	Lucht	€
2038-6694	AC HB 5/3 1/8" ZTUI Mid Gesl Handbediend met Zij-Tuimelaar		1/8" 41.85
2038-6702	AC HB 5/3 1/8" ZTUI Mid Geop Handbediend met Zij-Tuimelaar		1/8" 41.85
2038-6710	AC HB 5/3 1/8" ZTUI Mid Druk Handbediend met Zij-Tuimelaar		1/8" 41.85
2038-6728	AC HB 5/3 1/8" ZTUI Mid Gesl RTC Handbediend met Zij-Tuimelaar, Return To Centre		1/8" 44.85
2038-6736	AC HB 5/3 1/8" ZTUI Mid Geop RTC Handbediend met Zij-Tuimelaar, Return To Centre		1/8" 44.85
2038-6744	AC HB 5/3 1/8" ZTUI Mid Druk RTC Handbediend met Zij-Tuimelaar, Return To Centre		1/8" 44.85

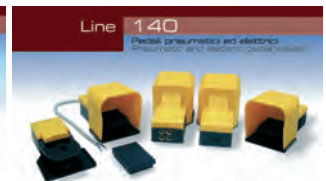

Handbediende ventielen

Serie 125 - 1/4"



5/2 handbediend ventiel - 1/4" BSP female

VEN	Funcie	Lucht	€
1252335001	AC HB 5/2 1/4" DK Veerr Handbediend met Drukknop, Veerretour		1/4" 36.00
1252335002	AC HB 5/2 1/4" DK Handbediend met Trek/Drukknop		1/4" 36.00
1252335003	AC HB 5/2 1/4" TUI Veerretour Handbediend met Tuimelaar, Veerretour		1/4" 39.60
1252335004	AC HB 5/2 1/4" TUI Handbediend met Tuimelaar		1/4" 38.40

5/3 handbediend ventiel - 1/4" BSP female

VEN	Funcie	Lucht	€
1252336013	AC HB 5/3 1/4" DK Mid Gesl RTC Handbediend met Drukknop, Return To Centre		1/4" 46.10
1252336014	AC HB 5/3 1/4" DK Mid Geop RTC Handbediend met Drukknop, Return To Centre		1/4" 46.10
1252336015	AC HB 5/3 1/4" DK Mid Druk RTC Handbediend met Drukknop, Return To Centre		1/4" 46.10
1252336001	AC HB 5/3 1/4" TUI Mid Gesl Handbediend met Tuimelaar		1/4" 51.40
1252336002	AC HB 5/3 1/4" TUI Mid Geop Handbediend met Tuimelaar		1/4" 51.40
1252336003	AC HB 5/3 1/4" TUI Mid Druk Handbediend met Tuimelaar		1/4" 51.40
1252336004	AC HB 5/3 1/4" TUI Mid Gesl RTC Handbediend met Tuimelaar, Return To Centre		1/4" 54.25
1252336005	AC HB 5/3 1/4" TUI Mid Geop RTC Handbediend met Tuimelaar, Return To Centre		1/4" 54.25
1252336006	AC HB 5/3 1/4" TUI Mid Druk RTC Handbediend met Tuimelaar, Return To Centre		1/4" 54.25

5/2 handbediend ventiel - zij uitvoering - 1/4" BSP female

VEN	Funcie	Lucht	€
1252335005	AC HB 5/2 1/4" ZTUI Veerr Handbediend met Zij-Tuimelaar, Veerretour		1/4" 44.00
1252335006	AC HB 5/2 1/4" ZTUI Handbediend met Zij-Tuimelaar		1/4" 44.00

5/3 handbediend ventiel - zij uitvoering - 1/4" BSP female

VEN	Funcie	Lucht	€
1252336007	AC HB 5/3 1/4" ZTUI Mid Gesl Handbediend met Zij-Tuimelaar		1/4" 46.10
1252336008	AC HB 5/3 1/4" ZTUI Mid Geop Handbediend met Zij-Tuimelaar		1/4" 46.10
1252336009	AC HB 5/3 1/4" ZTUI mid druk Handbediend met Zij-Tuimelaar		1/4" 46.10
1252336010	AC HB 5/3 1/4" ZTUI Mid Gesl RTC Handbediend met Zij-Tuimelaar, Return to Centre		1/4" 49.50
1252336011	AC HB 5/3 1/4" ZTUI Mid Geop RTC Handbediend met Zij-Tuimelaar, Return to Centre		1/4" 49.50
1252336012	AC HB 5/3 1/4" ZTUI Mid Druk RTC Handbediend met Zij-Tuimelaar, Return to Centre		1/4" 49.50

Serie 100 - 4mm push-in



2/2 handbediend micro ventiel - exclusief schakelaar - 4mm push-in

VEN	Funcie	Lucht	€
2038-6231	AC Micro HB 2/2 4mm NC ZS Handbediend, NC, Zonder Schakelaar		4mm Push-in 12.30

3/2 handbediend micro ventiel - exclusief schakelaar - 4mm push-in

VEN	Funcie	Lucht	€
2038-6330	AC Micro HB 3/2 4mm NC ZS Handbediend, NC, Zonder Schakelaar		4mm Push-in 12.30
2038-6348	AC Micro HB 3/2 4mm NO ZS Handbediend, NO, Zonder Schakelaar		4mm Push-in 13.55

Serie 100 - M5



2/2 handbediend micro ventiel - exclusief schakelaar - M5 female

VEN	Funcie	Lucht	€
2038-6058	AC Micro HB 2/2 M5 NC ZS Handbediend, NC, Zonder Schakelaar		M5 10.45

3/2 handbediend micro ventiel - exclusief schakelaar - M5 female

VEN	Funcie	Lucht	€
2038-6157	AC Micro HB 3/2 M5 NC ZS Handbediend, NC, Zonder Schakelaar		M5 10.45
2038-6165	AC Micro HB 3/2 M5 NO ZS Handbediend, NO, Zonder Schakelaar		M5 11.85

Voor basisplaten serie 125
zie pagina 591

KELM™
pneumatiek

Hydrauliek

Snel-
koppelingen

Afsluiters

Roestvast
staal

Fittingen

Lucht-
conditionering

Gereedschap

Pneumatiek

Diversen

Malleabele
fittingen
& staal

Ringleiding-
systemen

Slangen

Compressoren

Handbediende ventielen



Serie 120 - 1/8"



Maximale werkdruk:
0 - 10 bar

Let op: deze ventielen worden geleverd zonder schakelaar.



3/2 handbediend ventiel - exclusief schakelaar - 1/8" BSP female



2038-6942	AC HB 3/2 1/8" NC ZS Handbediend, NC, Zonder Schakelaar		1/8"	32.90
2038-6959	AC HB 3/2 1/8" NO ZS Handbediend, NO, Zonder Schakelaar		1/8"	32.90

5/2 handbediend ventiel - exclusief schakelaar - 1/8" BSP female



2038-7064	AC HB 5/2 1/8" ZS Handbediend, Zonder Schakelaar		1/8"	36.45
-----------	--	--	------	-------

Serie 125 - 1/4"



Maximale werkdruk:
1 - 10 bar



5/2 handbediend ventiel - exclusief schakelaar - 1/4" BSP female



1252535005	AC HB 5/2 1/4" ZS Handbediend, Zonder Schakelaar		1/4"	40.00
------------	--	--	------	-------

Schakelaars

Schakelaars met metalen behuizing voor handbediende ventielen zonder schakelaar van serie 100, 120 en 125.



Sleutelschakelaar



2038-7296	AC SSCHA-M 2S Sleutel Sleutelschakelaar, 2 Standen			37.45
-----------	--	--	--	-------

Draaischakelaar



2038-7304	AC SCHA-M 2S Draai 29,5 Draaischakelaar, 2 Standen, Handel 29,5mm			22.90
2038-7312	AC SCHA-M 2S draai 29,5, VR Draaischakelaar, 2 Standen, Veerretour, Handel 29,5mm			22.90
2038-7320	AC SCHA-M 3S Draai 29,5 Draaischakelaar, 3 Standen, Handel 29,5mm			22.90
2038-7338	AC SCHA-M 3S Draai 29,5, RTC Draaischakelaar, 3 Standen, Return to Centre, Handel 29,5mm			22.90
2038-7346	AC SCHA-M 2S Draai 39 Draaischakelaar, 2 Standen, Handel 39mm			23.70
2038-7361	AC SCHA-M 2S Draai 39, VR Draaischakelaar, 2 Standen, Veerretour, Handel 39mm			23.70
2038-7379	AC SCHA-M 3S Draai 39 Draaischakelaar, 3 Standen, Handel 39mm			23.70
2038-7387	AC SCHA-M 3S Draai 39, RTC Draaischakelaar, 3 Standen, Return to Centre, Handel 39mm			23.70

Knopkap (t.b.v. drukknopschakelaar)



1003A00048	AC Knopkap, Zwart T.b.v. Drukknopschakelaar		4.80
1003A00049	AC Knopkap, Rood T.b.v. Drukknopschakelaar		3.45
2038-7429	AC Knopkap, Blauw T.b.v. Drukknopschakelaar		4.50
2038-7437	AC Knopkap, Geel T.b.v. Drukknopschakelaar		4.50
2038-7445	AC Knopkap, Groen T.b.v. Drukknopschakelaar		4.50

Paddestoelschakelaar



2038-7510	AC BI 40mm Paddestoel, Rood Bidirectionele Paddestoelschakelaar		18.55
2038-7528	AC BI 40mm Paddestoel Zwart Bidirectionele Paddestoelschakelaar		18.20
2038-7585	AC DR 40mm Paddestoel, Rood Om as Draaiende Paddestoelschakelaar		29.65
2038-7593	AC DR 60mm Paddestoel, Rood Om as Draaiende Paddestoelschakelaar		34.45

Pookschakelaar



2038-7577	AC MU Pook, Rood Multidirectionele Pookschakelaar		26.60
-----------	---	--	-------

Mechanisch bediende ventielen



Serie 100 - 4mm push-in



Maximale werkdruk:
2 - 10 bar



2/2 mechanisch bediend micro ventiel - 4mm push-in

VEN		Funcie	Lucht	€
2038-6199	AC Micro MB 2/2 4mm NC SB Mechanisch, Stiftbediend		4mm Push-in	11.95
2038-6223	AC Micro MB 2/2 4mm NO SB Pan Mechanisch, Stiftbediend, Paneelmontage		4mm Push-in	13.35
2038-6249	AC Micro MB 2/2 4mm NC Hef Mechanisch Bediend met Hefboom		4mm Push-in	13.45

3/2 mechanisch bediend micro ventiel - 4mm push-in

VEN		Funcie	Lucht	€
2038-6256	AC Micro MB 3/2 4mm NC SB Mechanisch, Stiftbediend		4mm Push-in	11.95
2038-6264	AC Micro MB 3/2 4mm NO SB Mechanisch, Stiftbediend		4mm Push-in	13.35
2038-6314	AC Micro MB 3/2 4mm NC SB Pan Mechanisch, Stiftbediend, Paneelmontage		4mm Push-in	13.35
2038-6322	AC Micro MB 3/2 4mm NO SB Pan Mechanisch, Stiftbediend, Paneelmontage		4mm Push-in	14.75
2038-6355	AC Micro MB 3/2 4mm NC Hef Mechanisch Bediend met Hefboom		4mm Push-in	13.45
2038-6363	AC Micro MB 3/2 4mm NC Hef Mechanisch Bediend met Hefboom		4mm Push-in	14.95

Serie 100 - M5



Maximale werkdruk:
2 - 10 bar



2/2 mechanisch bediend micro ventiel - M5 female

VEN		Funcie	Lucht	€
2038-5852	AC Micro MB 2/2 M5 NC SB Mechanisch, Stiftbediend		M5	10.15
2038-6041	AC Micro MB 2/2 M5 NC SB Pan Mechanisch, Stiftbediend, Paneelmontage		M5	11.45
2038-6066	AC Micro MB 2/2 M5 NC Hef Mechanisch Bediend met Hefboom		M5	11.85

3/2 mechanisch bediend micro ventiel - M5 female

VEN		Funcie	Lucht	€
2038-6074	AC Micro MB 3/2 M5 NC SB Mechanisch, Stiftbediend		M5	10.15
2038-6082	AC Micro MB 3/2 M5 NO SB Mechanisch, Stiftbediend		M5	11.45
2038-6132	AC Micro MB 3/2 M5 NC SB Pan Mechanisch, Stiftbediend, Paneelmontage		M5	11.45
2038-6140	AC Micro MB 3/2 M5 NO SB Pan Mechanisch, Stiftbediend, Paneelmontage		M5	12.95
2038-6173	AC Micro MB 3/2 M5 NC Hef Mechanisch Bediend met Hefboom		M5	11.85
2038-6181	AC Micro MB 3/2 M5 NO Hef Mechanisch Bediend met Hefboom		M5	13.05

Serie 120 - 1/8"



Maximale werkdruk:
Zonder hulplucht 0 - 10 bar
Met hulplucht 1 - 10 bar



1 Richting

3/2 mechanisch bediend ventiel - 1/8" BSP female

VEN		Funcie	Lucht	€
2038-6751	AC MB 3/2 1/8" NC SB Mechanisch, Stiftbediend		1/8"	25.15
2038-6769	AC MB 3/2 1/8" NO SB Mechanisch, Stiftbediend		1/8"	25.15
2038-6777	AC MB 3/2 1/8" NC SB-HL Mechanisch, Stiftbediend, Hulplucht		1/8"	32.00
2038-6785	AC MB 3/2 1/8" NO SB-HL Mechanisch, Stiftbediend, Hulplucht		1/8"	32.00
2038-6793	AC MB120 3/2 1/8" NC SB-HL Pan Mechanisch, Stiftbediend, Hulplucht, Paneelmontage		1/8"	34.10
2038-6819	AC MB 3/2 1/8" NO SB-HL Pan Mechanisch, Stiftbediend, Hulplucht, Paneelmontage		1/8"	34.10
2038-6827	AC MB 3/2 1/8" NC VRA Mechanisch, Verlengde Rolarm Bediend		1/8"	33.65
2038-6835	AC MB 3/2 1/8" NO VRA Mechanisch, Verlengde Rolarm Bediend		1/8"	33.65
2038-6868	AC MB 3/2 1/8" NC RA-HL Mechanisch, Rolarm Bediend, Hulplucht		1/8"	38.05
2038-6876	AC MB 3/2 1/8" NO RA-HL Mechanisch, Rolarm Bediend, Hulplucht		1/8"	38.05
2038-6843	AC MB 3/2 1/8" NC RA1 Mechanisch, Rolarm Bediend, 1 Richting		1/8"	36.20
2038-6850	AC MB 3/2 1/8" NO RA1 Mechanisch, Rolarm Bediend, 1 Richting		1/8"	36.20
2038-6884	AC MB 3/2 1/8" NC RA1-HL, Mechanisch, Rolarm Bediend, 1 Richting, Hulplucht		1/8"	40.25
2038-6892	AC MB 3/2 1/8" NO RA1-HL, Mechanisch, Rolarm Bediend, 1 Richting, Hulplucht		1/8"	40.25
2038-6900	AC MB 3/2 1/8" NC HEF-HL Mechanisch, Hefboom Bediend, Hulplucht		1/8"	35.50
2038-6918	AC MB 3/2 1/8" NO HEF-HL Mechanisch, Hefboom Bediend, Hulplucht		1/8"	35.50
2038-6926	AC MB 3/2 1/8" NC ANT Mechanisch, Antenne Bediend		1/8"	37.15
2038-6934	AC MB 3/2 1/8" NO ANT Mechanisch, Antenne Bediend		1/8"	37.15

KELM™
pneumatiek

Hydrauliek

Snel-
koppelingen

Afsluiters

Roestvast
staal

Fittingen

Lucht-
conditionering

Gereedschap

Pneumatiek

Diversen

Malleabele
fittings &
staal

Ringleiding-
systemen

Slangen

Compressoren

Mechanisch bediende ventielen



Serie 120 - 1/8"



Maximale werkdruk:
Zonder hulplucht 0 - 10 bar
Met hulplucht 1 - 10 bar



1 Richting

5/2 mechanisch bediend ventiel - 1/8" BSP female

VEN		Functie	Lucht	€
2038-6975	AC MB 5/2 1/8" SB Veerr Mechanisch, Stiftbediend		1/8"	28.90
2038-6983	AC MB 5/2 1/8" SB-HL Veerr Mechanisch, Stiftbediend, Hulplucht		1/8"	35.50
2038-6991	AC MB 5/2 1/8" SB-HL Pan Veerr Mechanisch, Stiftbediend, Hulplucht, Paneelmontage		1/8"	42.30
2038-7007	AC MB 5/2 1/8" RA Veerr Mechanisch, Verlengde Rolarm Bediend		1/8"	37.85
2038-7023	AC MB 5/2 1/8" RA-HL Veerr Mechanisch, Rolarm Bediend, Hulplucht		1/8"	42.20
2038-7015	AC MB 5/2 1/8" RA1 Veerr Mechanisch, Rolarm Bediend, 1 Richting		1/8"	40.60
2038-7031	AC MB 5/2 1/8" RA1-HL Veerr Mechanisch, Rolarm Bediend, 1 Richting, Hulplucht		1/8"	44.50
2038-7049	AC MB 5/2 1/8" HEF-HL Veerr Mechanisch, hefboom Bediend, Hulplucht		1/8"	39.00
2038-7056	AC MB120 5/2 1/8" ANT-HL Veerr Mechanisch, Antenne Bediend, Hulplucht		1/8"	40.40

Serie 125 - 1/4"



Maximale werkdruk:
Zonder hulplucht 0 - 10 bar
Met hulplucht 1 - 10 bar



1 Richting

5/2 mechanisch bediend ventiel - 1/4" BSP female

VEN		Functie	Lucht	€
1252435001	AC MB 5/2 1/4" SB Veerr Mechanisch, Stiftbediend		1/4"	31.75
1252535001	AC MB 5/2 1/4" SB-HL Veerr Mechanisch, Stiftbediend, Hulplucht		1/4"	39.10
1252535004	AC MB 5/2 1/4" SB-HL Pan Veerr Mechanisch, Stiftbediend, Hulplucht, Paneelmontage		1/4"	44.10
1252435002	AC MB 5/2 1/4" RA Veerr Mechanisch, Rolarm Bediend		1/4"	38.65
1252535002	AC MB 5/2 1/4" RA-HL Veerr Mechanisch, Rolarm Bediend, Hulplucht		1/4"	46.25
1252435003	AC MB 5/2 1/4" RA1 Veerr Mechanisch, Rolarm Bediend, 1 Richting		1/4"	40.75
1252535003	AC MB 5/2 1/4" RA1-HL Veerr Mechanisch, Rolarm Bediend, 1 Richting, Hulplucht		1/4"	48.90
1252435006	AC MB 5/2 1/4" BA Veerr Mechanisch, Balarm Bediend		1/4"	40.40
1252435007	AC MB 5/2 1/4" BA1 Veerr Mechanisch, Balarm Bediend, 1 Richting		1/4"	42.50
1252535006	AC MB 5/2 1/4" HEF-HL Veerr Mechanisch, hefboom Bediend, Hulplucht		1/4"	42.70
1252535007	AC MB 5/2 1/4" ANT Veerr Mechanisch, Antenne Bediend		1/4"	39.75

Voor



FRL's

zie hoofdstuk 7



Voetbediende ventielen



Temperatuur:
-10°C t/m 50°C

Maximale werkdruk:
2 - 10 bar

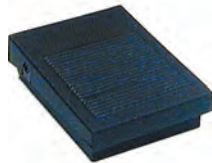
Serie 140 - 4mm push-in



3/2 voetbediend micro ventiel - monostabiel - zonder beschermkap - 4mm push-in

				
PED304M	AC Micro VB 3/2 4mm MS Voetbediend, Monostabiel		4mm Push-in	44.20



3/2 voetbediend ventiel - monostabiel - 4mm push-in

				
1407493001	AC VB 3/2 4mm BK MS Voetbediend, Beschermkap, Monostabiel		4mm Push-in	44.75

3/2 voetbediend ventiel - bistabiel - 4mm push-in

				
1407493003	AC VB 3/2 4mm BK BS Voetbediend, Beschermkap, Bistabiel		4mm Push-in	47.65

Serie 140 - 1/4"



5/2 voetbediend ventiel - monostabiel - zonder beschermkap - 1/4" BSP female

				
PED5502M	AC VB 5/2 1/4" MS Voetbediend, Monostabiel		1/4"	58.85

5/2 voetbediend ventiel - bistabiel - zonder beschermkap - 1/4" BSP female

				
1407535005	AC VB 5/2 1/4" BS Voetbediend, Bistabiel		1/4"	62.35



5/2 voetbediend ventiel - monostabiel - 1/4" BSP female

				
PED502S	AC VB 5/2 1/4" BK MS Voetbediend, Beschermkap, Monostabiel		1/4"	65.90

5/2 voetbediend ventiel - bistabiel - 1/4" BSP female

				
PED502B	AC VB 5/2 1/4" BK BS Voetbediend, Beschermkap, Bistabiel		1/4"	69.55



Serie 140 - elektrische schakelaar 24/230V

Temperatuur:
-25°C t/m 70°C

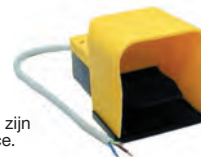
Verschillende uitvoeringen zijn leverbaar met safety device.



Voetbediend ventiel - elektrische schakelaar 24/230V - monostabiel - levering met kabel

		
1407660801	AC VB Elektr Schak BK MS Voetbediend, Beschermkap, Monostabiel	43.40

Voor



terugslagkleppen
zie hoofdstuk 4



KELM™
pneumatiek

Hydrauliek

Snel-
koppelingen

Afsluiters

Roestvast
staal

Fittingen

Lucht-
conditionering

Gereedschap

Pneumatiek

Diversen

Malleabele
fittings
& staal

Ringleiding-
systemen

Slangen

Compressoren

Luchtbediende ventielen



Medium:

Gesmeerde of ongesmeerde geconditioneerde perslucht



Temperatuur:
-5°C tot 50°C



FLOW Serie 120: 490 L/min bij 6 bar /ΔP 1
Serie 125: 800 L/min bij 6 bar /ΔP 1



Huis Kunststof (technopolymeer)
Delen, messing en RVS



NBR

Serie 120 - 1/8"



Maximale werkdruk:

Werkdruk: 0 - 10 bar
Stuurdruk: Monostabiel: 1 - 10. bar
Bistabiel: 0,5 - 10 bar

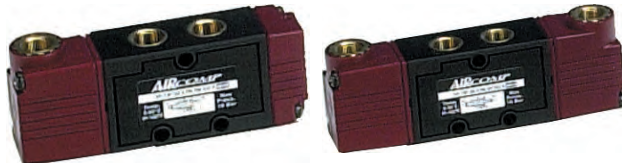

3/2 luchtbediend ventiel - 1/8" BSP female

VEN		Functie	Lucht	€
2038-6371	AC LB 3/2 1/8" HL NC Lucht - Veer, Hulplucht		1/8"	25.90
2038-6389	AC LB 3/2 1/8" HL NO Lucht - Veer, Hulplucht		1/8"	25.90
2038-6397	AC LB 3/2 1/8" Bistabiel Lucht - Lucht		1/8"	30.20
2038-6405	AC LB 3/2 1/8" Differentieel Lucht - Lucht, Luchtretour		1/8"	31.15

5/2 luchtbediend ventiel - 1/8" BSP female

VEN		Functie	Lucht	€
2038-6413	AC LB 5/2 1/8" HL Veerretour Lucht - Veer, Hulplucht		1/8"	29.00
2038-6421	AC LB 5/2 1/8" Bistabiel Lucht - Lucht		1/8"	31.65
2038-6439	AC LB 5/2 1/8" Differentieel Lucht - Lucht, Luchtretour		1/8"	35.20

5/3 luchtbediend ventiel - 1/8" BSP female

VEN		Functie	Lucht	€
2038-6447	AC LB 5/3 1/8" Midden Gesloten RTC Lucht - Lucht, Return to Centre		1/8"	48.25
2038-6454	AC LB 5/3 1/8" Midden Geopend RTC Lucht - Lucht, Return to Centre		1/8"	48.25
2038-6462	AC LB 5/3 1/8" Midden Druk RTC Lucht - Lucht, Return to Centre		1/8"	48.25

Serie 125 - 8mm push-in



Maximale werkdruk:

Werkdruk: 0 - 10 bar
Stuurdruk: 5/2 Monostabiel: 1 - 10. 5/2 bar
Bistabiel/differentieel: 0,5 - 10. 5/3 bar
Bistabiel: 2,1 - 10 bar



5/2 luchtbediend ventiel - 8mm push-in

VEN		Functie	Lucht	€
1252295001	Ac Lb 5/2 8mm Veerr Lucht - Veer, Hulplucht		8mm Push-in	31.35
1252295002	Ac Lb 5/2 8mm Bistabiel Lucht - Lucht		8mm Push-in	34.00
1252295003	Ac Lb 5/2 8mm Differentieel Lucht - Lucht, Luchtretour		8mm Push-in	37.75

5/3 luchtbediend ventiel - 8mm push-in

VEN		Functie	Lucht	€
1252296001	Ac Lb 5/3 8mm Midden Gesloten Rtc Lucht - Lucht, Return To Centre		8mm Push-in	48.70
1252296002	Ac Lb 5/3 8mm Midden Geopend Rtc Lucht - Lucht, Return To Centre		8mm Push-in	48.70
1252296003	Ac Lb 5/3 8mm Midden Druk Rtc Lucht - Lucht, Return To Centre		8mm Push-in	48.70

Serie 125 - 1/4"



5/2 luchtbediend ventiel - 1/4" BSP female

VEN		Functie	Lucht	€
1252235001	AC LB 5/2 1/4" Veerr Lucht - Veer, Hulplucht		1/4"	31.65
1252235002	AC LB 5/2 1/4" Bistabiel Lucht - Lucht		1/4"	35.20
1252235003	AC LB 5/2 1/4" Differentieel Lucht - Lucht, Luchtretour		1/4"	39.70

5/3 luchtbediend ventiel - 1/4" BSP female

VEN		Functie	Lucht	€
1252236001	AC LB 5/3 1/4" Midden Gesloten RTC Lucht - Lucht, Return To Centre		1/4"	51.60
1252236002	AC LB 5/3 1/4" Midden Geopend RTC Lucht - Lucht, Return To Centre		1/4"	51.60
1252236003	AC LB 5/3 1/4" Midden Druk RTC Lucht - Lucht, Return To Centre		1/4"	51.60

Elektropneumatische schuifventielen



Isolatie klasse (IP) IP65 **Temperatuur:** -5°C tot 50°C **Type manual override:** Monostabiel

EM120
120 serie = SINGLE USE

Huis Kunststof (technopolymeer) Delen, messing en RVB **SEAL** NBR

FLOW Serie 20: 490 L/min bij 6 bar /ΔP 1
Serie 125: 800 L/min bij 6 bar /ΔP 1

spoel Type spoel = 22 mm **WATT** DC = 3 watt
AC = 7,5 VA



Serie 120 - 1/8"

Maximale werkdruk:
Werkdruk: Monostabiel: 1 - 10 bar
Bistabiel: 0,5 - 10 bar

3/2 schuifventiel - 1/8" BSP female - met manual override - zonder spoel en stekker

VEN		Functie	Lucht	€
1202123001	AC EPV- 120 3/2 1/8" NC Elek/Pneu - Veer (Interne Hulplucht)		1/8"	38.20
1202123002	AC EPV-120 3/2 1/8" NO Elek/Pneu - Veer (Interne Hulplucht)		1/8"	38.20
1202123003	AC EPV-120 3/2 1/8" Elek/Pneu - Elec/pneu		1/8"	57.35

Maximale werkdruk:
Monostabiel: 1 - 10 bar
Bistabiel: 0 - 10 bar

5/2 schuifventiel - 1/8" BSP female - met manual override - zonder spoel en stekker

VEN		Functie	Lucht	€
1202125001	AC EPV-120 5/2 1/8" VEERR Elek-Pneu - Veer (Interne Hulplucht)		1/8"	41.05
1202125002	AC EPV-120 5/2 1/8" Elek-Pneu - Elek-Pneu		1/8"	60.00

5/3 schuifventiel - 1/8" BSP female - met manual override - zonder spoel en stekker

VEN		Functie	Lucht	€
1202126001	AC EPV-120 5/3 1/8" MC - RTC Elek-Pneu - Elek-Pneu / Middenstand Gesloten / Return to Centre		1/8"	75.40
1202126002	AC EPV-120 5/3 1/8" MO - RTC Elek-Pneu - Elek-Pneu / Middenstand Geopend / Return to Centre		1/8"	75.40
1202126003	AC EPV-120 5/3 1/8" MD - RTC Elek-Pneu - Elek-Pneu / Middenstand Onder Druk / Return to Centre		1/8"	75.40

Serie 120 - 1/8" - pilot

Maximale werkdruk:
Werkdruk: 0 - 10 bar
Stuurdruk: Monostabiel: 1 - 10 bar
Bistabiel: 0,5 - 10 bar

3/2 pilot schuifventiel - 1/8" BSP female - met manual override - zonder spoel en stekker

VEN		Functie	Lucht	€
1202123004	AC EPV-120 3/2 1/8" AM5- NC Elek/Pneu / Pilot - Veer (Interne Hulplucht) Aansluiting Pilot: M5		1/8"	42.70
1202123007	AC EPV-120 3/2 1/8" A4MM-NC Elek/Pneu / Pilot - Veer (Interne Hulplucht) Aansluiting Pilot: 4mm Push-in		1/8"	43.70
1202123005	AC EPV-120 3/2 1/8" AM5-NO Elek/Pneu / Pilot - Veer (Interne Hulplucht) Aansluiting Pilot: M5		1/8"	42.70
1202123008	AC EPV-120 3/2 1/8" A4MM-NO Elek/Pneu / Pilot - Veer (Interne Hulplucht) Aansluiting Pilot: 4mm Push-in		1/8"	43.70
1202123006	AC EPV-120 3/2 1/8" AM5 Elek/Pneu / Pilot - Elek/Pneu / Pilot Aansluiting Pilot: M5		1/8"	65.10
1202123009	AC EPV-120 3/2 1/8" A4MM Elek/Pneu / Pilot - Elek/Pneu / Pilot Aansluiting Pilot: 4mm Push-in		1/8"	67.25



KELM™ pneumatiek

Hydrauliek

Snelkoppelingen

Afsluiters

Roestvast staal

Fittingen

Luchtconditionering

Gereedschap

Pneumatiek

Diversen

Malleabele fittingen & staal

Ringleidingssystemen

Slangen

Compressoren

Elektropneumatische schuifventielen



EM120
120 serie = SINGLE USE



Serie 120 - 1/8" - pilot

Maximale werkdruk:
Werkdruk: 0 - 10 bar
Stuurdruk: 5/2: 0,5 - 10 bar. 5/3: 2,1 - 10 bar

5/2 pilot schuifventiel - 1/8" BSP female - met manual override - zonder spoel en stekker

VEN		Functie	Lucht	€
1202125003	AC EPV-120 5/2 1/8" AM5 VEERR Elek-Pneu / Pilot - Veer (Interne Hulplucht) Aansluiting Pilot: M5		1/8"	46.25
1202125005	AC EPV-120 5/2 1/8" A4MM VEERR Elek-Pneu / Pilot - Veer (Interne Hulplucht) Aansluiting Pilot: 4mm Push-in		1/8"	47.10
1202125004	AC EPV-120 5/2 1/8" AM5 Elek-Pneu / Pilot - Elek-Pneu / Pilot Aansluiting Pilot: M5		1/8"	67.25
1202125006	AC EPV-120 5/2 1/8" A4MM Elek-Pneu / Pilot - Elek-Pneu / Pilot Aansluiting Pilot: 4mm Push-in		1/8"	68.60

5/3 pilot schuifventiel - 1/8" BSP female - met manual override - zonder spoel en stekker

VEN		Functie	Lucht	€
1202126004	AC EPV-120 5/3 1/8" AM5 MC - RTC Elek-Pneu / Pilot - Elek-Pneu / Pilot / Middenstand Gesloten/Return to Centre Aansluiting Pilot: M5		1/8"	81.35
1202126007	AC EPV-120 5/3 1/8" A4MM MC - RTC Elek-Pneu / Pilot - Elek-Pneu / Pilot / Middenstand Gesloten/Return to Centre Aansluiting Pilot: 4mm Push-in		1/8"	83.00
1202126005	AC EPV-120 5/3 1/8" AM5 MO - RTC Elek-Pneu / Pilot - Elek-Pneu / Pilot / Middenstand Geopend/Return to Centre Aansluiting Pilot: M5		1/8"	81.35
1202126008	AC EPV-120 5/3 1/8" A4MM MO - RTC Elek-Pneu / Pilot - Elek-Pneu / Pilot / Middenstand Geopend/Return to Centre Aansluiting Pilot: 4mm Push-in		1/8"	83.00
1202126006	AC EPV-120 5/3 1/8" AM5 MD - RTC Elek-Pneu / Pilot - Elek-Pneu / Pilot / Middenstand Druk/Return to Centre Aansluiting Pilot: M5		1/8"	81.35
1202126009	AC EPV-120 5/3 1/8" A4MM MD - RTC Elek-Pneu / Pilot - Elek-Pneu / Pilot / Middenstand Druk/Return to Centre Aansluiting Pilot: 4mm Push-in		1/8"	83.00

EM125
125 serie = SINGLE USE
& BATTERY ASSEMBLY



Serie 125 - 1/4"

Maximale werkdruk:
Werkdruk: 5/2 met veerretour: 1 - 10 bar
5/2 zonder veerretour en 5/3: 0 - 10 bar

5/2 schuifventiel - 1/4" BSP female - met manual override - zonder spoel en stekker

VEN		Functie	Lucht	€
1252135001	AC EPV-125 5/2 1/4" VEERR Elek-Pneu - Veer (Interne Hulplucht)		1/4"	46.25
1252135002	AC EPV-125 5/2 1/4" Elek-Pneu - Elek-Pneu		1/4"	67.25

5/3 schuifventiel - 1/4" BSP female - met manual override - zonder spoel en stekker

VEN		Functie	Lucht	€
1252136001	AC EPV-125 5/3 1/4" MC - RTC Elek-Pneu - Elek-Pneu / Middenstand Gesloten/Return to Centre		1/4"	84.00
1252136002	AC EPV-125 5/3 1/4" MO - RTC Elek-Pneu - Elek-Pneu / Middenstand Geopend/Return to Centre		1/4"	84.00
1252136003	AC EPV-125 5/3 1/4" MD - RTC Elek-Pneu - Elek-Pneu / Middenstand Onder Druk/Return to Centre		1/4"	84.00

Serie 125 - 1/4" - pilot

5/2 pilot schuifventiel - 1/4" BSP female - met manual override - zonder spoel en stekker

VEN		Functie	Lucht	€
1252135003	AC EPV-125 5/2 1/4" ACTM5-VEERR Elek-Pneu / Pilot - Veer (interne hulplucht) Aansluiting Pilot: M5		1/4"	51.95
1252135004	AC EPV-125 5/2 1/4" ACTM5 Elek-Pneu / Pilot - Elek-Pneu / Pilot Aansluiting Pilot: M5		1/4"	75.05

5/3 pilot schuifventiel - 1/4" BSP female - met manual override - zonder spoel en stekker

VEN		Functie	Lucht	€
1252136004	AC EPV-125 5/3 1/4" ACTM5 MC - RTC Elek-Pneu / Pilot - Elek-Pneu / Pilot / Middenstand Gesloten/Return to Centre Aansluiting Pilot: M5		1/4"	91.25
1252136005	AC EPV-125 5/3 1/4" ACTM5 MO - RTC Elek-Pneu / Pilot - Elek-Pneu / Pilot / Middenstand Geopend/Return to Centre Aansluiting Pilot: M5		1/4"	91.25
1252136006	AC EPV-125 5/3 1/4" ACTM5 MD - RTC Elek-Pneu / Pilot - Elek-Pneu / Pilot / Middenstand Druk/Return to Centre Aansluiting Pilot: M5		1/4"	91.25

Spoelen en stekkers



22mm spoel - voor ventielen serie 120, 125 en EM110

VEN		€
A502600018	12V DC	6.15
2039-7238	24V DC	5.65
2039-7253	24V/50-60Hz AC	5.65
2039-7279	110V/50-60Hz AC	5.65
2039-7287	220V/50-60Hz AC	5.65
1341A00001	24DC EXPLOSIEVEILIG	64.30



22mm stekker

VEN	€
2039-7205	1.70

Basisplaat



Basisplaat - voor ventielen serie 125

VEN		€
2039-6727	AC Basisplaat 125, 2 Posities	15.65
2039-6735	AC Basisplaat 125, 3 Posities	21.50
2039-6743	AC Basisplaat 125, 4 Posities	27.40
2039-6750	AC Basisplaat 125, 5 Posities	33.35
2039-6768	AC Basisplaat 125, 6 Posities	39.25
2039-6776	AC Basisplaat 125, 7 Posities	44.85
2039-6784	AC Basisplaat 125, 8 Posities	50.90
2039-6792	AC Basisplaat 125, 9 Posities	56.75
2039-6800	AC Basisplaat 125, 10 Posities	62.65
2039-7932	AC Blindplaat V Basisplaat 125	1.00

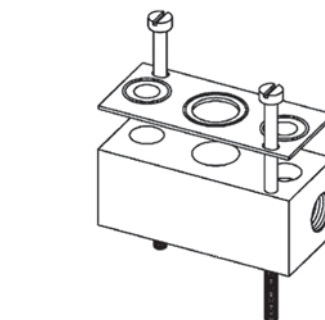

Drukscheidingskit - voor bevestiging van ventielen serie 125 op basisplaat (verschillende werkdrukken)

VEN	€
1325C00001	25.65

Serie EM110 - koppeling en bevestiging



Bevestigingsmoer voor spoel - bij batterijmontage ventielen serie EM110

VEN	€
1311A00015	0.30

Magneetventielen - batterijmontage



Type manual override:
Bistabiel

Isolatie klasse (IP) IP65

Temperatuur:
-5°C tot 50°C

Werkdruk:
0 - 10

Huis Kunststof (PBT)
Delen, messing en RVS

NBR

0,08 KG

50 L/min bij 6 bar /ΔP 1

Type spoel = 22 mm

DC = 3 watt
AC = 7,5 VA

De Aircomp EM110 serie is ontwikkeld voor batterijmontage.

De magneetventielen worden met een koppelingsstuk aan elkaar verbonden en kunnen aan DIN EN50022 rails worden bevestigd. Luchtaansluiting is aan 2 zijden mogelijk (TYPE LINKS / RECHTS).

Het is ook mogelijk tegelijk aan beide kanten lucht met verschillende druk in te laten. Zie onderstaande schema.

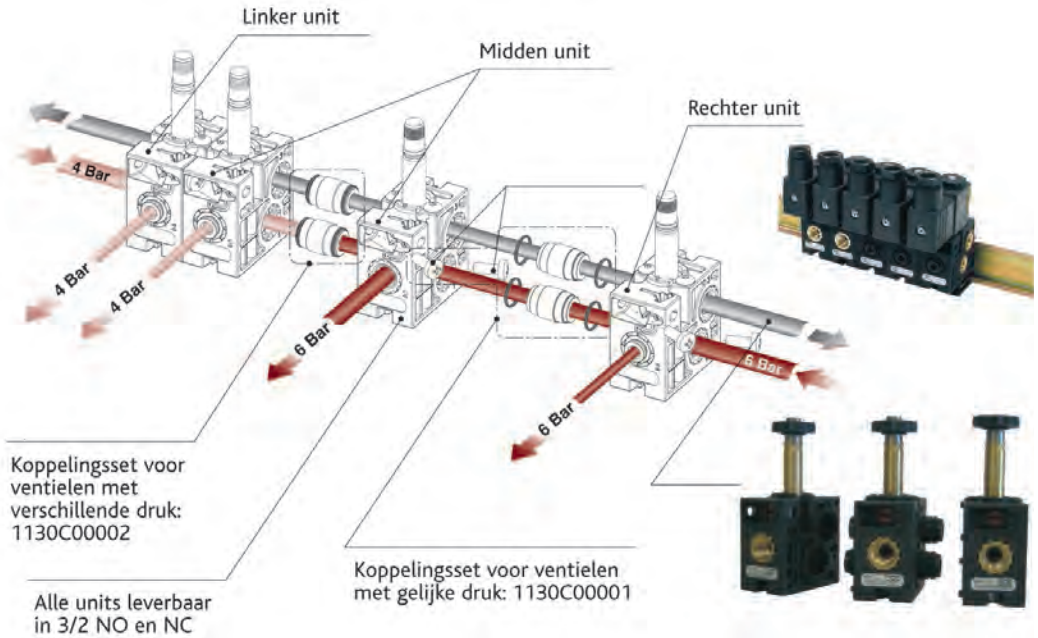

Serie EM110 - 1/8"



3/2 direct werkend magneetventiel -
1/8" BSP female - linker unit - met manual override -
zonder spoel en stekker

3/2 direct werkend magneetventiel -
1/8" BSP female - rechter unit - met manual override -
zonder spoel en stekker

VEN	Functie	Lucht	€
1103023009	AC BAT EM110 3/2 1/8" NC LI Elektrisch - Veer, Links Inlaat		22.15
1103023010	AC BAT EM110 3/2 1/8" NO LI Elektrisch - Veer, Links Inlaat		30.90
1103023013	AC BAT EM110 3/2 1/8" NC LU Elektrisch - Veer, Links Uitlaat		21.05
1103023014	AC BAT EM110 3/2 1/8" NO LU Elektrisch - Veer, Links Uitlaat		29.80

VEN	Functie	Lucht	€
1103023011	AC BAT EM110 3/2 1/8" NC RI Elektrisch - Veer - Rechts Inlaat		22.15
1103023012	AC BAT EM110 3/2 1/8" NO RI Elektrisch - Veer - Rechts Inlaat		30.90
1103023015	AC BAT EM110 3/2 1/8" NC RU Elektrisch - Veer - Rechts Uitlaat		21.05
1103023016	AC BAT EM110 3/2 1/8" NO RU Elektrisch - Veer - Rechts Uitlaat		29.80

Serie EM110 - 4mm push-in



3/2 direct werkend magneetventiel - 4mm push-in - midden unit - met manual override - zonder spoel en stekker



1103093007 AC BAT EM110 3/2 4mm NC Midden Elektrisch - Veer  4mm Push-in **22.15**

1103093008 AC BAT EM110 3/2 4mm NO Midden Elektrisch - Veer  4mm Push-in **31.15**





3/2 direct werkend magneetventiel - 4mm push-in - linker unit - met manual override - zonder spoel en stekker



1103093009 AC BAT EM110 3/2 4mm NC LI Elektrisch - Veer, Links Inlaat  4mm Push-in **23.45**

1103093010 AC BAT EM110 3/2 4mm NO LI Elektrisch - Veer, Links Inlaat  4mm Push-in **32.05**

1103093013 AC BAT EM110 3/2 4mm NC LU Elektrisch - Veer - Links Uitlaat  4mm Push-in **22.15**

1103093014 AC BAT EM110 3/2 4mm NO LU Elektrisch - Veer - Links Uitlaat  4mm Push-in **31.15**





3/2 direct werkend magneetventiel - 4mm push-in - rechter unit - met manual override - zonder spoel en stekker



1103093011 AC BAT EM110 3/2 4mm NC RI Elektrisch - Veer - Rechts Inlaat  4mm Push-in **23.45**

1103093012 AC BAT EM110 3/2 4mm NO RI Elektrisch - Veer - Rechts Inlaat  4mm Push-in **32.05**

1103093015 AC BAT EM110 3/2 4mm NC RU Elektrisch - Veer - Rechts Uitlaat  4mm Push-in **22.15**

1103093016 AC BAT EM110 3/2 4mm NO RU Elektrisch - Veer - Rechts Uitlaat  4mm Push-in **31.15**

Serie EM110 - 1/8"



3/2 direct werkend magneetventiel - 1/8" BSP female - midden unit - met manual override - zonder spoel en stekker



1103023007 AC BAT EM110 3/2 1/8" NC Midden Elektrisch - Veer  1/8" **21.05**

1103023008 AC BAT EM110 3/2 1/8" NO Midden Elektrisch - Veer  1/8" **29.80**

Serie EM110 - koppeling en bevestiging

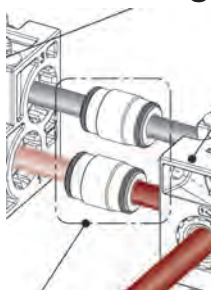

Koppelingskit - voor onderlinge koppeling van ventielen serie EM110



1130C00001 AC Bventiel Koppel Gelijke Druk **1.85**

1130C00002 AC Bventiel Koppel Ongelijke Druk **3.15**



Bevestigingsstuk - voor bevestiging ventielen serie EM110 aan DIN EN50022 (35mm) rails



1130C00003 AC ventielbevestiging V rails **2.80**

Vlakzuignap type B

Toepassing: Oppakken van gladde en vlakke producten.



Veiligheid: Het opgegeven draagvermogen is de theoretische waarde bij een bedrijfsvacuüm van 60%, zonder veiligheidsfactor.



NBR of siliconen



Type B - NBR

VAZU	H mm	kg	DIA mm	DIA mm	€
ZN3B-NBR	6	0,03	1	3	4.15
ZN6B-NBR	12	0,15	2	6	4.50
ZN10B-NBR	13	0,235	3	10	5.40
ZN16B-NBR	20	0,8	5	16	6.15
ZN25B-NBR	30	1,5	8	25	9.40



Type B - siliconen

VAZU	H mm	kg	DIA mm	DIA mm	€
ZN3B-SIL	6	0,03	1	3	5.65
ZN6B-SIL	12	0,15	2	6	6.95
ZN10B-SIL	13	0,235	3	10	7.95
ZN16B-SIL	20	0,8	5	16	9.75
ZN25B-SIL	30	1,5	8	25	11.85

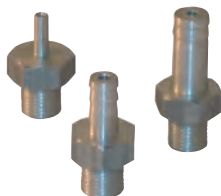

Adapters voor type B vlakke zuignappen - aluminium

VAZU	To Suit	C	H mm	BSPP	DIA mm	DIA mm	€
BSCN-A1	6B-10B	8	18	1/8"	2	3,5	6.05
BSCN-A2	16B	13	25	1/8"	4,7	9	7.60
BSCN-A3	25B	14	28	1/8"	5	9	8.35

Vlakzuignap type A

Robuuste stijve zuignappen met een relatief klein intern volume.

Toepassing: Oppakken van gladde en vlakke producten.



Veiligheid: Het opgegeven draagvermogen is de theoretische waarde bij een bedrijfsvacuüm van 60%, zonder veiligheidsfactor.



NBR of siliconen



Type A - NBR

VAZU	H mm	kg	DIA mm	DIA mm	€
ZN20A-NBR	15	1,0	4,8	20	3.25
ZN28A-NBR	15	1,8	4,8	28	3.60
ZN38A-NBR	23	3,4	8,0	38	3.95
ZN45A-NBR	26,5	4,8	9,0	45	4.40
ZN60A-NBR	25	7,9	9,0	60	5.00
ZN75A-NBR	38	10	9,0	75	6.45



Type A - siliconen

VAZU	H mm	kg	DIA mm	DIA mm	€
ZN20A-SIL	15	1,0	4,8	20	4.25
ZN28A-SIL	15	1,8	4,8	28	4.70
ZN38A-SIL	23	3,4	8,0	38	5.40
ZN45A-SIL	26,5	4,8	9,0	45	6.45
ZN60A-SIL	25	7,9	9,0	60	7.20
ZN75A-SIL	38	10	9,0	75	11.15

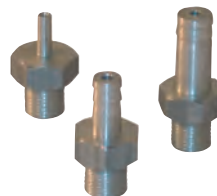

Adapters voor type A vlakke zuignappen - aluminium

VAZU	To Suit	C	H mm	BSPP	DIA mm	DIA mm	€
BSCN-A2	20A-28A	13	25	1/8"	4,7	9	7.60
BSCN-A3	38A-75A	14	28	1/8"	5	9	8.35

KELM™
pneumatiek

Hydrauliek

Snel-
koppelingen

Afsluiters

Roestvast
staal

Fittingen

Lucht-
conditionering

Gereedschap

Pneumatiek

Diversen

Malleabele
fittingen
& staal

Ringleiding-
systemen

Slangen

Compressoren

Balgzuignap type D

Flexibele constructie met 1,5 vouwen. Hierdoor past de zuignap zich aan het voorwerppoppervlak aan.

Toepassing: Palletiseer- en stapelinrichtingen.



Veiligheid: Het opgegeven draagvermogen is de theoretische waarde bij een bedrijfsvacuüm van 60%, zonder veiligheidsfactor.



NBR of siliconen



Type D - 1,5 vouwen - NBR

VAZU	H mm	kg	DIA mm	DIA mm	€
ZN11D-NBR	16	0,117	5	11	3.15
ZN16D-NBR	19	0,23	5	16	3.25
ZN20D-NBR	16	0,47	5	20	3.40
ZN22D-NBR	19	0,53	5	22	3.45
ZN25D-NBR	23	0,57	5	25	3.60
ZN37D-NBR	27	1,3	8	37	3.60
ZN43D-NBR	27	2,3	8	43	4.85
ZN53D-NBR	33	5,2	8	53	7.80
ZN80D-NBR	46	14	11,8	80	12.95



Type D - 1,5 vouwen - siliconen

VAZU	H mm	kg	DIA mm	DIA mm	€
ZN11D-SIL	16	0,117	5	11	3.30
ZN16D-SIL	19	0,23	5	16	3.45
ZN20D-SIL	16	0,47	5	20	3.60
ZN22D-SIL	19	0,53	5	22	3.75
ZN25D-SIL	23	0,57	5	25	3.85
ZN37D-SIL	27	1,3	8	37	6.45
ZN43D-SIL	27	2,3	8	43	7.60
ZN53D-SIL	33	5,2	8	53	10.45
ZN80D-SIL	46	14	11,8	80	17.35



Adapters voor type D balgzuignappen - aluminium

VAZU	BSPP	To Suit	H mm	DIA mm	€	
BSCN-E4	Male 1/4"	37D - 53D	17	32	4	7.60
BSCN-E5	Male 1/4"	78D - 80D	17	38	4	7.60
BSCN-G3	Female 1/8"	37D - 53D	14	30	4	9.15
BSCN-G4	Female 1/4"	37D - 53D	17	31	4	9.40
BSCN-G5	Female 1/4"	78D - 80D	17	38	4	9.40
BSCN-E1	Male 1/8"	11D - 25D	13	24,5	4,5	9.15
BSCN-E3	Male 1/4"	11D - 25D	17	24,5	4,5	9.40
BSCN-P4	Male 1/4"	37D - 53D	17	29,5	1	10.90

Balgzuignap type E

Zeer flexibele constructie met 2,5 vouwen, zorgt voor een uitstekende aanpassing aan het voorwerp. Tevens goede hoogteverschil vereffening.

Toepassing: Palletiseer- en stapelinrichtingen.



Veiligheid: Het opgegeven draagvermogen is de theoretische waarde bij een bedrijfsvacuüm van 60%, zonder veiligheidsfactor.



NBR of siliconen



Type E - 2,5 vouwen - siliconen

VAZU	H mm	kg	DIA mm	€
ZN7E-SIL	14	0,01	7	3.40
ZN9E-SIL	15	0,068	9	3.45
ZN14E-SIL	23	0,11	14	3.60
ZN18E-SIL	23	0,23	18	3.75
ZN20E-SIL	23	0,38	20	3.95
ZN25E-SIL	34	0,45	25	4.25
ZN32E-SIL	37,5	1,2	32	5.15
ZN42E-SIL	46	1,4	42	6.95
ZN62E-SIL	55	3,9	62	9.30
ZN88E-SIL	87,5	4,5	88	18.20



Type E - 2,5 vouwen - NBR

VAZU	H mm	kg	DIA mm	€
ZN14E-NBR	23	0,11	14	3.45
ZN18E-NBR	23	0,23	18	3.70
ZN20E-NBR	23	0,38	20	3.85
ZN25E-NBR	34	0,45	25	3.85
ZN32E-NBR	37,5	1,2	32	4.65
ZN42E-NBR	46	1,4	42	5.40
ZN62E-NBR	55	3,9	62	7.75
ZN88E-NBR	87,5	4,5	88	17.35
ZN7E-NBR	14	0,01	7	3.25
ZN9E-NBR	15	0,068	9	3.30



Adapters voor type E balgzuignappen - aluminium

VAZU	BSPP	To Suit	H mm	DIA mm	€	
BSCN-E4	Male 1/4"	32E - 62E	17	32	4	7.60
BSCN-E5	Male 1/4"	88E	17	38	4	7.60
BSCN-G3	Female 1/8"	32E - 62E	14	30	4	9.15
BSCN-G4	Female 1/4"	32E - 62E	17	31	4	9.40
BSCN-G5	Female 1/4"	88E	17	38	4	9.40
BSCN-E1	Male 1/8"	7E - 25E	13	24,5	4,5	9.15
BSCN-E3	Male 1/4"	7E - 25E	17	24,5	4,5	9.40
BSCN-P4	Male 1/4"	32E - 62E	17	29,5	1	10.90

KELM™
pneumatiek

Hydrauliek

Snel-
koppelingen

Afsluiters

Roestvast
staal

Fittingen

Lucht-
conditionering

Gereedschap

Pneumatiek

Diversen

Malleabele
fittings
& staal

Ringleiding-
systemen

Slangen

Compressoren

Balgzuignap type C

Flexibele constructie met 1,5 vouwen. Hierdoor past de zuignap zich aan het voorwerppoppervlak aan. Met 8mm gaten voor drageraansluiting.

Toepassing: Palletiseerinrichtingen en zwaardere werkstukken.



Veiligheid: Het opgegeven draagvermogen is de theoretische waarde bij een bedrijfsvacuüm van 60%, zonder veiligheidsfactor.



NBR of siliconen



Type C - 1,5 vouwen - NBR

VAZU	H mm	kg	DIA mm	€
ZN110C-NBR	58	29	110	43.40
ZN150C-NBR	70	58	150	73.75



Type C - 1,5 vouwen - siliconen

VAZU	H mm	kg	DIA mm	€
ZN110C-SIL	58	29	110	79.45
ZN150C-SIL	70	58	150	137.90

Vlakzuignap type F

Zware industriële zuignap met geprofileerde binnenzijde en 8mm gaten voor drageraansluiting.

Toepassing: Palletiseerinrichtingen en zwaardere werkstukken.



Veiligheid: Het opgegeven draagvermogen is de theoretische waarde bij een bedrijfsvacuüm van 60%, zonder veiligheidsfactor.



NBR of siliconen



Type F - NBR

VAZU	H mm	kg	DIA mm	€
ZN120F-NBR	25,5	51	120	33.25
ZN150F-NBR	32,5	65	150	36.10
ZN200F-NBR	39	141	200	47.65



Type F - siliconen

VAZU	H mm	kg	DIA mm	€
ZN120F-SIL	25,5	51	120	56.40
ZN150F-SIL	32,5	65	150	60.70
ZN200F-SIL	39	141	200	88.10



Drager voor balgzuignap type C en vlakzuignap type F

VAZU	H mm	DIA mm	€
AD106801	3/8"	13	32.95
AD106800	1/2"	13	32.95
AD106802	1/4"	13	32.95

Venturi vacuümpomp

Vacuüm creëren met Venturi pompen

Het principe van een Venturi is het omzetten van persluchtdruk in luchtsnelheid. De Venturi creëert vacuüm met als energiebron perslucht.

De luchtstroom gaat door een vernauwing en wordt daarna gecontroleerd geëxpandeerd.

Bij de expansie heeft de luchtstroom de maximale snelheid, daar treedt dan ook de maximale op (vacuüm) met als gevolg dat de atmosferische lucht wordt aangezogen in de Venturi.

Om het maximale rendement te behalen is een optimale binnen geometrie essentieel.



De icoontjes **PRES** en **VAC** geven respectievelijk de aansluitingsschroefdraad van de persluchtaanvoer en de vacuümaansluiting aan.

Toepassingen: Machinebouw, pick- en place units, verpakkingsmachines, manipulators, fixatie etc.



Aluminium St-51



50



1/4" BSP



40



28



1/2" BSP

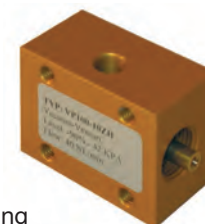
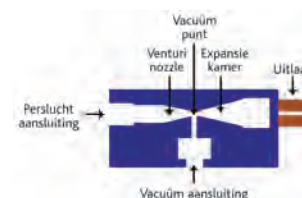

1/2" BSP female vacuümaansluiting

VACU	ID mm	bar	Lucht L/min	FLOW	Vacuüm bar	€
VENTURI-100-08ZH	0,8	5,5	40	30	-0,9	66.25
VENTURI-100-10ZH	1	4,5	55	40	-0,9	59.30
VENTURI-100-13ZH	1,3	4,5	80	65	-0,9	59.30
VENTURI-100-15ZH	1,5	4,5	135	90	-0,9	59.30
VENTURI-100-17ZH	1,7	4,5	170	110	-0,9	59.30
VENTURI-100-08ZM	0,8	5,5	44	40	-0,6	66.25
VENTURI-100-10ZM	1	5,5	55	60	-0,6	59.30
VENTURI-100-13ZM	1,3	5,5	80	90	-0,6	59.30
VENTURI-100-15ZM	1,5	5,5	130	140	-0,6	59.30



Professionals in Flow & Fluid Technology

Tel
Fax
Website
E-mail

+31(0) 499 49 10 90
+31(0) 499 49 63 70
www.aimfluid.nl
info@aimfluid.nl

aim fluid control b.v.
Ekkersrijt 7310
NL-5692 HH Son en Breugel
The Netherlands

