

2015



Professionals in
Flow & Fluid Technology

	Pneumatisch gereedschap	AEROPRO ENGINEERED FOR PROFESSIONALS	Pagina 476		Brandstofapparaat		Pagina 497
	Veerbalancers		Pagina 480		Smeernippels, vetspuiten & -slangen	CISSON	Pagina 497
	JWL blaaspistolen	JWL AIR CONTROL <i>Air Boy®</i>	Pagina 482		Verfspuiten		Pagina 499
	Rectus blaaspistolen	Parker RECTUS TEMA	Pagina 486		Jetwash hogedrukslang	HiPRHO	Pagina 501
	AIR-PRO, KELM™ & CDC blaaspistolen		Pagina 488		Jaymac spuitpistolen - lagedruk	JAYMAC Industrial Hoses & Accessories	Pagina 502
	Air Jet nozzles	KELMK Enhanced Quality Performance	Pagina 491		Hiprho spuitpistolen & lansen	HiPRHO	Pagina 504
	CEJN blaaspistolen	CEJN	Pagina 492		Watersnelkoppelingen hogedruk	HiPRHO	Pagina 510
	Bandenpompen		Pagina 494		Iride reinigingspistolen & lansen		Pagina 511
	Digitale bandenpompen	AIR-PRO	Pagina 495		Nito spuitpistolen	Nito	Pagina 515
	Hogedruk snijringkoppelingen LL	CISSON	Pagina 496		Metaal- & houtboren	Five	Pagina 516

VEILIGHEIDSTIPS:

Hieronder algemeen advies voor het gebruik van persluchtgereedschap, om schade en letsel te voorkomen op de werkplek.

(Dit is geen vervanging voor de **AEROPRO** veiligheidsvoorschriften/handleidingen).



VISUELE INSPECTIE VOOR GEBRUIK

Controleer het gereedschap, luchtslang en fittingen op tekenen van beschadiging, overmatige slijtage of defecten. Zorg ervoor dat het gereedschap is gesmeerd.

GEBRUIK DE JUISTE ACCESSOIRES

Alleen aanbevolen accessoires gebruiken met **AEROPRO** gereedschap. Gebruik bijvoorbeeld nooit handdoppen bij slagmoersleutels. Ontkoppel altijd de luchttoevoer voor het vervangen van een accessoire.

BESCHERMINGSMIDDELEN

Draag altijd noodzakelijke persoonlijke beschermingsmiddelen bij bediening van het gereedschap, zoals een veiligheidsbril en oordopjes. Draag afhankelijk van de toepassing ook handschoenen, een schort, helm & stofmasker. Zorg voor stofafzuiging bij het werken met materialen waarbij schadelijke deeltjes vrijkomen in de lucht, om blootstelling te voorkomen.

EEN VEILIGE WERKOMGEVING

Maak andere mensen bewust van uw werkgebied en zorg dat men op veilige afstand wordt gehouden. Houdt de werkomgeving schoon en verlicht en het vloeroppervlak vrij van struikelgevaar. Leidt de luchtafvoer af van uzelf en anderen. Gebruik het gereedschap niet in een explosieve atmosfeer en altijd weghouden van elektrische bedrading.

Accessoires pneumatisch gereedschap



MATISCH GEREEDSCHAP

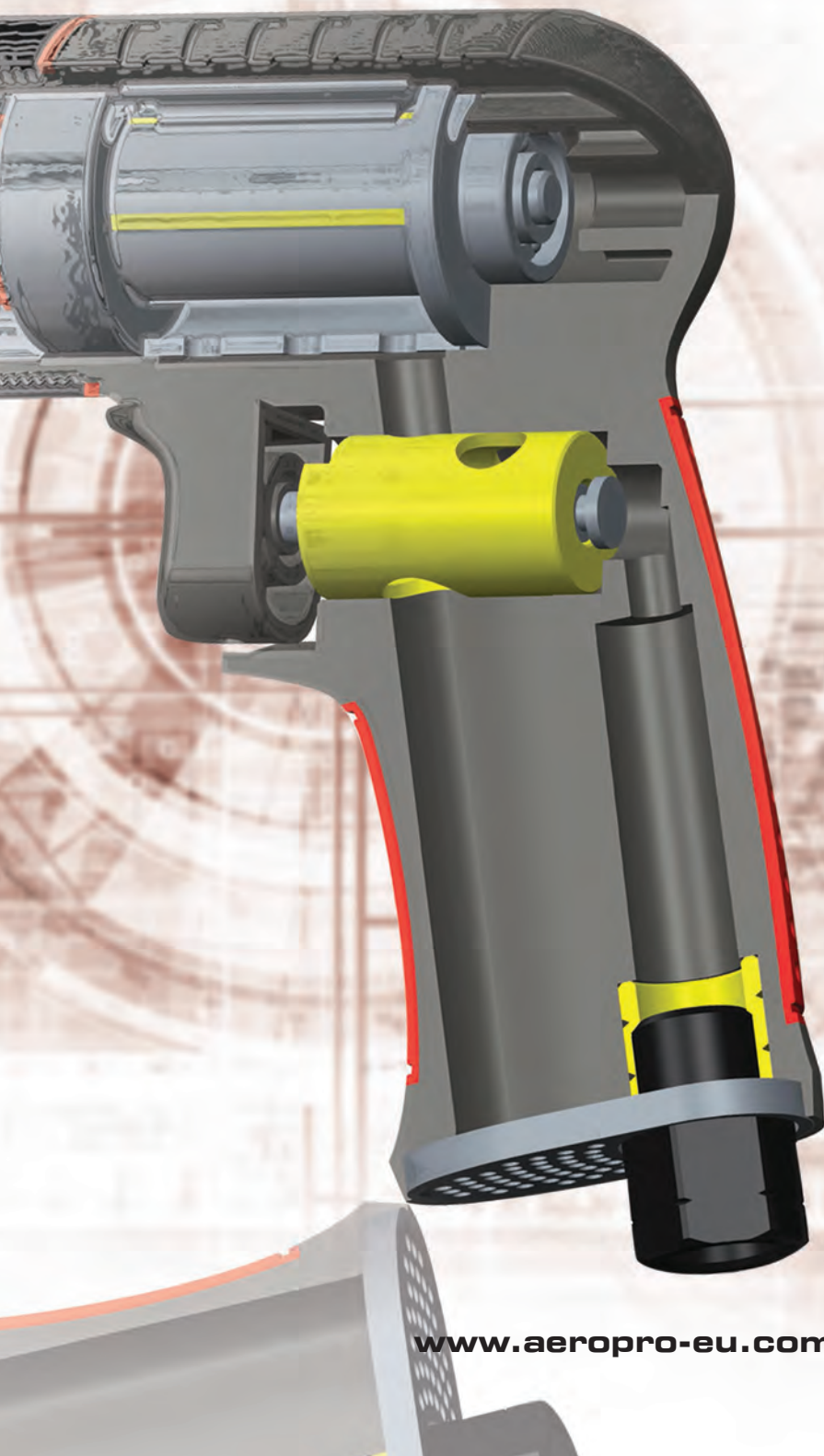

EIGENSCHAPPEN & VOORDELEN

Ontwerp:

Aantrekkelijk design,
lichtgewicht & comfortabele
composit handgreep.

Kwaliteit:

Ontworpen volgens superieure
technologie en vervaardigd met
precisie voor levering van een
groter vermogen en een langere
levensduur.

Robuust:

Volledig geharde planetaire
tandwielen verminderen wrijving
en warmtebehandelde onderdelen
zorgen voor een verhoogde
duurzaamheid.

Garantie:

12 maanden fabrieksgarantie.



www.aeropro-eu.com

Ratelsleutel

- Ontworpen volgens superieure technologie en vervaardigd met precisie voor levering van een groter vermogen en een langere levensduur.
- Volledig geharde planetaire tandwielen verminderen wrijving.
- Comfortabele handgreep.
- Eenvoudige dopwisseling.
- Warmtebehandelde onderdelen voor verhoogde duurzaamheid.
- Lichtgewicht aluminium behuizing.
- Compacte kop maakt gebruik in moeilijk bereikbare ruimtes mogelijk.
- Handige greepbediening voor het wijzigen van de draairichting.
- Luchtuitlaat: zijkant
- Aanbevolen werkdruk: 6 bar



Tech Sheet
10236

Model No.	Square Drive	Capacity Bolt Size		Free Speed RPM	Working Torque		Overall Length		Air Inlet	Air Hose (ID)	Average Air Consumption		Net Weight	
		Imp	Met mm		Ft-Lb	N.m	In	mm			cfm	l/min	Lbs	Kgs
AP17411	3/8"	1/2	13	160	50	68	10.8	275	1/4"	3/8"	3	85.5	2.5	1.15

3/8" ratelsleutel - vierkantaandrijving

0373



AP17411-3/8

55.55



Tech Sheet
10236

Model No.	Square Drive	Capacity Bolt Size		Free Speed RPM	Working Torque		Overall Length		Air Inlet	Air Hose (ID)	Average Air Consumption		Net Weight	
		Imp	Met mm		Ft-Lb	N.m	In	mm			cfm	l/min	Lbs	Kgs
AP17411	1/2"	1/2"	13	160	50	68	10	254	1/4"	3/8"	2.7	77	2.4	1.1

1/2" ratelsleutel - vierkantaandrijving

0373



AP17411-1/2

55.55

Slagmoersleutelset

- Het Twin hammer slagmechanisme heeft 2 identieke hamers die een evenwichtige klap leveren, dit vermindert trilling en de hoge energie die vrijkomt wordt direct doorgestuurd naar het aandrijfviertak voor maximaal vermogen.
- Afgeschermd luchtinlaat voorkomt beschadiging van het gereedschap door vuil en puin.
- Luchtuitlaat: achterzijde
- Aanbevolen werkdruk: 6 bar

Tech Sheet
10238

Model No.	Square Drive	Capacity Bolt Size		Free Speed RPM	Working Torque		Overall Length		Air Inlet	Air Hose (ID)	Average Air Consumption		Net Weight	
		Imp	Met mm		Ft-Lb	N.m	In	mm			cfm	l/min	Lbs	Kgs
AP17407	1/2"	5/8"	16	7,500	410	555	7.30	187.4	1/4"	3/8"	6.5	183.5	4.9	2.26

Slagmoersleutel

- Het Twin hammer slagmechanisme heeft 2 identieke hamers die een evenwichtige klap leveren, dit vermindert trilling en de hoge energie die vrijkomt wordt direct doorgestuurd naar het aandrijfviertak voor maximaal vermogen.
- Afgeschermd luchtinlaat voorkomt beschadiging van het gereedschap door vuil en puin.
- Luchtuitlaat: achterzijde
- Aanbevolen werkdruk: 6 bar



Tech Sheet
10235

Model No.	Square Drive	Capacity Bolt Size		Free Speed RPM	Working Torque		Overall Length		Air Inlet	Air Hose (ID)	Average Air Consumption		Net Weight	
		Imp	Met mm		Ft-Lb	N.m	In	mm			cfm	l/min	Lbs	Kgs
AP7451	1/2"	5/8"	16	7,500	450	610	7.48	190	1/4"	3/8"	6.5	183.9	4.2	1.9

1/2" slagmoersleutel - vierkantaandrijving

0373



AP7451

114.95



Tech Sheet
10237

Model No.	Square Drive	Capacity Bolt Size		Free Speed RPM	Working Torque		Overall Length		Air Inlet	Air Hose (ID)	Average Air Consumption		Net Weight	
		Imp	Met mm		Ft-Lb	N.m	In	mm			cfm	l/min	Lbs	Kgs
AP7460	3/4"	1"	25	7,250	1200	1627	8.2	208	3/8"	1/2"	9.5	269	7.0	3.2

3/4" slagmoersleutel - vierkantaandrijving

0373



AP7460

219.60

Inhoud:

- 1x AP17407 1/2" slagmoersleutel
- 10x slagdop (9, 10, 11, 13, 14, 17, 19, 22, 24, 27mm)
- 1x 5" verlengstuk
- 1x flesje olie
- 1x inbussleutel
- 1x mini nevelaar
- 1x insteeknippel
- 1x draagkoffer

1/2" slagmoersleutel - vierkantaandrijving - 17-delige set

0373



AP17808

123.55



Omkeerbare rechte boormachine

- Compacte en handzame boormachine.
- Precisie-bewerkte tandwielen garanderen maximale vermogensoverdracht en duurzaamheid.
- Lichtgewicht - helpt vermoeidheid bij langdurig gebruik te voorkomen.
- Ideaal voor gebruik op plaatsen waar ruimte beperkt is.
- Aanbevolen werkdruk: 6 bar



Tech Sheet
10239

Model No.	Chuck Size	Free Speed RPM	Air Inlet	Air Hose (ID)	Overall Length		Average Air Consumption		Net Weight	
					In	mm	cfm	l/min	Lbs	Kgs
AP17111	3/8"	2,600	1/4"	3/8"	8.8	225	4.0	115	1.87	0.85

3/8" boormachine - tandkransboorhouder

0373



AP17111

44.85

Hakhamer

- Ergonomische handgreep voor comfort en stabiliteit.
- Warmtebehandelde impact onderdelen voor een verhoogde duurzaamheid.
- Gasgreep en ingebouwde vermogensregelaar voor eenvoudige kracht- en snelheidscontrole.
- Afgeschermdeluchtinlaat voorkomt beschadiging door vuil en puin.
- Standaard snelwisselveer voor snelle en eenvoudige bitelwisseling.
- Luchtuitlaat: voorzijde
- Aanbevolen werkdruk: 6 bar

Inclusief 4-delige bitelset.



Tech Sheet
10242

Model No.	Chisel Shank mm	Blows per min	Air Inlet	Air Hose (ID)	Overall Length		Average Air Consumption		Net Weight	
					In	mm	cfm	l/min	Lbs	Kgs
AP17621	10.2	4,500	1/4"	3/8"	6.10	155	2.8	79.8	2.65	1.2

Heavy duty

0373



AP17621

29.95

Omkeerbare boormachine

- Compacte en handzame boormachine.
- Doseerbare gasgreep voor een makkelijke start.
- Precisie-bewerkte tandwielen garanderen maximale vermogensoverdracht en duurzaamheid.
- Handige drukknop voor verandering van draairichting
- Lichtgewicht - helpt vermoeidheid bij langdurig gebruik te voorkomen.
- Stille werking met achteruitlaat - leidt lucht weg van de werkplek.
- Constructie met kogellagers.
- Aanbevolen werkdruk: 6 bar



Tech Sheet
10240

Model No.	Chuck Size	Free Speed RPM	Air Inlet	Air Hose (ID)	Overall Length		Average Air Consumption		Net Weight	
					In	mm	cfm	l/min	Lbs	Kgs
AP17101	3/8"	1,800	1/4"	3/8"	7	180	3.7	104	1.98	0.9

3/8" boormachine - tandkransboorhouder

0373



AP17101

48.95



Tech Sheet
10241

Model No.	Chuck Size	Free Speed RPM	Air Inlet	Air Hose (ID)	Overall Length		Average Air Consumption		Net Weight	
					In	mm	cfm	l/min	Lbs	Kgs
AP17107	1/2"	700	1/4"	3/8"	7.68	195	4	115	1.18	1.19

1/2" boormachine - tandkransboorhouder

0373



AP17107

56.65

Stiftslijper

- Lichtgewicht aluminium behuizing.
- Veiligheidsgreep voorkomt onopzettelijke start.
- Luchtuitlaat: achterzijde
- Toepassing: afwerking van lasnaden, polijsten, slijpen, frezen en afbramen.
- Aanbevolen werkdruk: 6 bar

Tech Sheet
10243



Model No.	Grinder Cap	Free Speed RPM	Air Inlet	Air Hose (ID)	Average Air Consumption		Net Weight	
					cfm	l/min	Lbs	Kgs
AP17313	1/4"	20,000	1/4"	3/8"	3	86.25	0.70	0.32

1/4" stiftslijper - recht

0373



AP17313

24.20

- Haakse slijpkop biedt toegang tot moeilijk bereikbare ruimtes.
- Lichtgewicht aluminium behuizing.
- Luchtuitlaat: achterzijde
- Toepassing: afwerking van lasnaden, polijsten, slijpen, frezen en afbramen.
- Aanbevolen werkdruk: 6 bar

Tech Sheet
10244



Model No.	Grinder Cap	Free Speed RPM	Air Inlet	Air Hose (ID)	Average Air Consumption		Net Weight	
					cfm	l/min	Lbs	Kgs
AP17315	1/4"	20,000	1/4"	3/8"	2.2	62	0.99	0.45

1/4" stiftslijper - haaks

0373



AP17315

44.50

Haakse slijper

- Ingebouwde regelaar voor snelheidscontrole.
- Planetair tandwielmechanisme.
- Luchtuitlaat: zijkant
- Aanbevolen werkdruk: 6 bar

Tech Sheet
10245



Model No.	Sanding Pad In mm	Free Speed RPM	Air Inlet	Air Hose (ID)	Average Air Consumption		Net Weight	
					cfm	l/min	Lbs	Kgs
AP7319	4"	10,000	1/4"	3/8"	5	140	2.86	1.3
	5"							

4" haakse slijper - heavy duty

0373



AP7319

52.25

Pneumatische basisset

Inhoud:

- Verfspuitpistool
- Blaaspistool
- Bandenpomp
- Spuitpistool
- 5 meter PE spiraalslang met Euro snelkoppeling



5-delige set

0373



AP8031K5G

48.20

1/2" slagdopset

Bevat zeskantmaten:

11, 12, 13, 14, 16, 17, 19, 21, 22 en 24mm

Gehard staal - zeer robuust en voor intensief gebruik.

Wordt geleverd in kunststof kist.



Metrisch - 10-delige set

0373

AP7006



21.35

Bevat zeskantmaten:

3/8", 7/16", 1/2", 9/16", 5/8", 11/16", 3/4", 13/16", 7/8", 15/16" & 1"

Gehard staal - zeer robuust en voor intensief gebruik.

Wordt geleverd in stalen kist.



Imperial - 11-delige set

0373

AP7007



38.05

Snelspanboorkop



3/8" & 1/2"

0373

APKLC38
APKLC12

To
Suit

3/8"
1/2"



10.65
11.35

Veer voor hakhamer



Geschikt voor AP17621

0373

AP7001



2.25

Beitelset

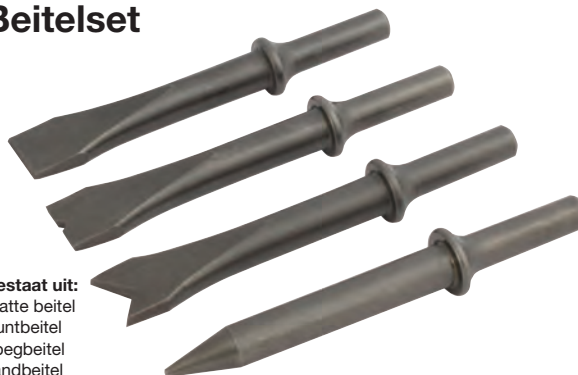

Bestaat uit:
Platte beitel
Puntbeitel
Voegbeitel
Tandbeitel

Geschikt voor AP17621 - 4-delige set

0373

AP7002-7



4.65

Veerbalancers

Veerbalancer



Airpro veerbalancers



Instelbaar

GERE	kg	L mm	€
2021-0209	0,6 - 1,5	1,6	29.15
2021-0217	1 - 2	1,6	29.15
2021-0225	1,5 - 3	1,5	45.80
2021-2030	3 - 5	1,5	61.45



Redashe

Redashe professionele veerbalancers

Verstelbare maximale lengte

Nauwkeurig verstelbare veer

Incl. veiligheidsmechanisme



Huis: Gegoten aluminium

Kabel: Roestvast staal



Heavy duty - instelbaar

GERE	kg	L mm	€
M9311	0,4 - 1	1,6	85.05
M9312	1 - 2	1,6	121.10
M9313	2 - 3	1,6	138.45
M9320	1 - 2,5	2	209.95
M9321	2 - 4	2	230.35
M9322	4 - 6	2	266.00
M9323	6 - 8	2	304.40
M9331	2 - 4	2,5	256.95
M9332	4 - 6	2,5	364.05
M9333	6 - 8	2,5	425.55
M9334	8 - 10	2,5	460.30
M9335	10 - 14	2,5	553.70

Schuifmaten

Schuifmaat - digitaal

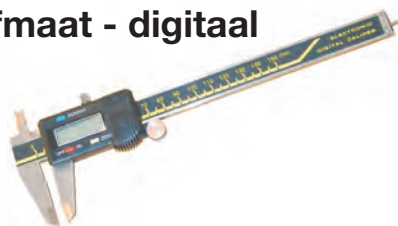

Meetbereik 0-150mm

DRIL	€
24600150	22.00

Schuifmaat



Meetbereik 0-150mm

DRIL	€
24602150	11.50

A I R C O N T R O L



Made in Denmark

Blaaspistolen

Industriële topkwaliteit, robuust en slagvast, gegarandeerd lekvrij.

Toepassingen: bouw, garages, industrie, informatie technologie, laboratoria, elektronica algemeen, voedingsindustrie.

Materiaal: huis, greep en klep: acetaal kunststof
 veer: gehard staal
 blaaspijp: verzinkt staal.
 dichting en O-ring: NBR

Temperatuur:
 -10°C tot +80°C

Maximale druk: 16 bar
Geadviseerde maximale werkdruk: 8 bar

FLOW
 Gemeten bij 8 bar

! Draag altijd een veiligheidsbril.

Air Boy® Classic blaaspistool



Tech Data
10676

Standaard - gebogen blaaspijp - BSP female

BLAA	Nozzle	BSPPP	FLOW	€
14010213	6mm gebogen	1/4"	330	15.25
14010113	8mm gebogen	1/4"	380	13.65
14012013	8mm gebogen RVS	1/4"	380	31.45



Tech Data
10676

Standaard - zonder blaaspijp - BSP female

BLAA	Nozzle	BSPPP	FLOW	€
140858-000	1/4" schroefdraad	1/4"	380	12.80



Tech Data
10677

Regelbaar - gebogen blaaspijp - BSP female

BLAA	Nozzle	BSPPP	FLOW	€
14010413	6mm gebogen	1/4"	330	26.20
14010313	8mm gebogen	1/4"	380	26.95



Tech Data
10680

Met Venturi nozzle - gebogen blaaspijp - BSP female

BLAA	Nozzle	BSPPP	FLOW	€
14011013	6mm gebogen	1/4"	300	33.45
14011113	8mm gebogen	1/4"	300	33.45



Tech Data
10678

Verlengd - rechte lange blaaspijp - BSP female

BLAA	Nozzle	BSPPP	FLOW	€
14011213	8mm recht - 300mm	1/4"	380	26.10
14011313	8mm recht - 500mm	1/4"	380	28.70
14011413	8mm recht - 1000mm	1/4"	380	33.90

Air Boy® Anti-Block blaaspistool



Tech Data
10681

Met ontluchting - gebogen blaaspijp - BSP female

BLAA	Nozzle	BSPPP	FLOW	€
140106-000	6mm gebogen	1/4"	330	22.80



Tech Data
10679

FOOD RVS POM - gebogen blaaspijp - BSP female

BLAA	Nozzle	BSPPP	FLOW	€
140120-159	8mm gebogen	1/4"	380	32.30

Air Boy® Safety blaaspistool



Tech Data
10682

Automatische drukverlaging - rechte blaaspijp - BSP female

BLAA	Nozzle	BSPPP	FLOW	€
14016013	8mm recht - max. 2 bar	1/4"	140	71.20
14017013	8mm recht - max. 3.5 bar	1/4"	220	71.20

Blaaspistolen

 **Temperatuur:**
-10°C tot +80°C

 **Maximale druk: 16 bar**
Geadviseerde maximale werkdruk: 8 bar

Air Boy® Silent blaaspistool



Tech Data
10683

Geluidgedempt -
gebogen blaaspijp - BSP female

				
14012513	8mm gebogen	1/4"	260	27.70

Geluidgedempt - rechte blaaspijp - BSP female

				
14012613	8mm recht	1/4"	260	29.90



Tech Data
10684

Geluidgedempt en regelbaar -
gebogen blaaspijp - BSP female

				
14013513	8mm gebogen	1/4"	260	38.40

Geluidgedempt en regelbaar -
rechte blaaspijp - BSP female

				
14013613	8mm recht	1/4"	260	40.45

Air Boy® Super Silent blaaspistool



Tech Data
10685

 **Maximale druk: 12 bar**
Geadviseerde maximale werkdruk: 8 bar

Geluidgedempt en hoge blaaskracht -
gebogen blaaspijp - BSP female

				
140141-000	8mm gebogen RVS	1/4"	330	30.90

Geluidgedempt en hoge blaaskracht -
rechte blaaspijp - BSP female





				
140140-000	8mm recht RVS	1/4"	330	30.90

Air Boy® pomppistool



Tech Data
10686

Met pompnaald voor o.a. voetbal
- BSP female





				
14010813	Pomppistool	1/4"	200	32.85
14010814	Losse blaasnaald	-	-	10.30

Air Boy® bandenpomppistool



Tech Data
10687

Met pompnippel - gebogen blaaspijp
- BSP female

				
14011813	8mm gebogen	1/4"	380	37.40

Bandenpompnippel



Voor auto of fiets

			
15011000	Euro profiel voor auto	300	21.00
15011100	Euro profiel voor fiets	300	21.00
15011200	Pilaar 7.9mm voor auto	300	20.55
15011300	Pilaar 7.9mm voor fiets	300	20.55

Blaaspistolen

Jet Air Boy® nozzle



Tech Data
10688

POM - luchtzuinig



14100013

1/4"

0-580

32mm

16.65



Tech Data
10688

ULTEM1000 200°C - geluidsarm



14100113

1/4"

0-580

32mm

21.55

Air Boy® nozzle



Tech Data
10689

Venturi nozzle



14011606

Bypass voor 6mm blaaspijp

9.00

14011508

Bypass voor 8mm blaaspijp

8.50

Zodra gemonteerd kan onderstaande reinigungsnozzle niet meer gedemonteerd worden



Tech Data
10690

90° reinigungsnozzle



144177

Nozzle voor 8mm blaaspijp

23.35

Sodablaster



- Voertuigen stralen kan nu snel en zonder beschadiging van de carrosserie.
- Verwijdert lak, verf en oppervlakterest binnen enkele seconden, zonder opwarming of rekking van het plaatstaal.
- Glas, rubber en kunststof beschadigen niet bij gebruik van de Sodablaster.
- Tevens geschikt voor het reinigen van o.a. velgen, kleppen, zuigers en andere onderdelen.
- Niet alleen toepasbaar bij voertuigen, maar bijvoorbeeld ook verf van kozijnen en vernis van houten meubilair.
- Door gebruik van soda zeer mild en milieuvriendelijk; soda is een natuurlijk oplosbaar product.



Tech Data
10287

**Maximale
werkdruk:
6 tot 12 bar**

Met 1,2 liter reservoir - BSP female



145150-000

1/4"

180

123.40



Tech Data
10287

Soda - 5 liter



320103-000

28.70

Blaaspistolen

Reinigingspistool



Maximale werkdruk:
6 tot 12 bar



Tech Data
10691

Met 1,2 liter reservoir - rechte blaaspijp - BSP female

BLAA	Nozzle	BSPP	FLOW	€
14210013	Met messing nozzle - 260mm	1/4"	100	62.10
14210113	Met messing nozzle - 145mm	1/4"	100	61.05
14211013	Met messing nozzle - 1000mm	1/4"	100	68.55
14213513	Met POM nozzle - 200mm	1/4"	100	52.40

Waspistool



Maximale werkdruk:
6 tot 10 bar



Tech Data
10692

Met Gardena nippel - rechte blaaspijp - BSP female

BLAA	Nozzle	FLOW	BSPP	€
14218013	Met POM nozzle	380	1/4"	56.85

Remontluchter



Maximale werkdruk:
6 tot 12 bar



Tech Data
10693

Compleet met slang, nippel en 1,2 liter reservoir - BSP female

BLAA		FLOW	BSPP	€
14310013	Remontluchter compleet	180	1/4"	110.20
14320500	Losse rubber nippel	-	-	13.95

Zandstraalpistool

Tech Data
10694



Met zuigbuis - BSP female

BLAA		BSPP	FLOW	€
14510200	Zandstraalpistool met zuigbuis	1/4"	450	147.30
14521900	Losse nozzle voor 14510200	-	-	17.45

De JWL gritstraalpistolen zijn geschikt voor korrelgroottes tussen 0,3 en 0,6 mm



Tech Data
10695

Met 1,2 liter reservoir - BSP female

BLAA		BSPP	FLOW	€
14510013	Zandstraalpistool 1.2L	1/4"	450	64.20
14520200	Losse nozzle voor 14510013	-	-	10.95

Tectyleerpistool

Tech Data
10696



Voor vloeistof op water- en oliebasis - BSP female

BLAA		BSPP	FLOW	€
14613413	Pistool - met plastic zuigbuis	1/4"	180-380	56.75
14610113	Pistool - met metalen zuigbuis	1/4"	180-380	62.80
14610813	Pistool - met 2 zuigbuizen en verlengslang	1/4"	180-380	119.15
14610013	Pistool - met 1,2 liter reservoir	1/4"	180-380	61.05
14611090	Verlengslang ø8 x 900mm	1/4"	100	20.15

KELM™
pneumatiek

Hydrauliek

Snel-
koppelingen

Afsluiters

Roestvast
staal

Fittingen

Lucht-
conditionering

Gereedschap

Pneumatiek

Diversen

Malleabele
fittings
& staal

Ringleiding-
systemen

Slangen

Compressoren

Blaaspistolen



Blaaspistolen types AJ-AV

Toepassingen: Bouw, garages, hobby, industrie, installateurs, landbouw, motoren revisie, productie, scheepsbouw, textiel, voedingsmiddelen.

Nozzles: kort, lang, vast of verwisselbaar. Verwisselbare spuitmond M12x1,25.

Venturi nozzles zuigen 2/3 omgevingslucht mee waardoor maximale airflow is gegarandeerd.

Laag geluidsniveau: 63 tot 73 dB.



Temperatuur:
-20°C tot 70°C



Maximale werkdruk:
6 bar



Max. 380 L/min



Aluminium of slagvast kunststof

Hoofdstuk 8 – Gereedschap

Blaaspistool - box van 10 stuks



Type AJ 13 - gebogen aluminium blaaspip - rood slagvast kunststof

BLAA	OD mm	€
29020613	6	190.50
29020813	8	196.15



Type AK 13 - gebogen aluminium blaaspip - blauw slagvast kunststof

BLAA	OD mm	€
29020013	8	178.55

Type AK 13 heeft een niet verwisselbare nozzle

Blaaspistool - aluminium



Type AA - standaard nozzle - BSP female

BLAA	BSPP	€
29030013	1/4"	23.45



Type AS - veiligheidsnozzle (verwisselbaar) - BSP female

BLAA	BSPP	€
29040013	1/4"	33.55



Type AR - gesinterde metalen nozzle (verwisselbaar) - BSP female

BLAA	BSPP	€
29050013	1/4"	30.65



Type AV - verlengde gebogen metalen blaaspip (verwisselbaar) - BSP female

BLAA	BSPP	€
29060013	1/4"	37.85



Type AT - Venturi nozzle (verwisselbaar) - BSP female

BLAA	BSPP	€
29070013	1/4"	35.25

KELM™ pneumatiek

Hydrauliek

Snelkoppelingen

Afsluiters

Roestvast staal

Fittingen

Luchtconditionering

Gereedschap

Pneumatiek

Diversen

Malleabele fittingen & staal

Ringleidingssystemen

Slangen

Compressoren

Blaaspistool - slagvast kunststof



Type AN - standaard nozzle - BSP female



29080013

1/4"

17.95



Type AC - gebogen messing vernikkelde blaaspijp - BSP female



29220013

1/4"

21.25



Type AM - zonder nozzle - M12 x 1,25 female nozzleaansluiting - BSP female



29250013

M12 x 1.25

18.25



Type AK - gebogen aluminium blaaspijp - BSP female



29200013

1/4"

17.80



Type AX - Venturi nozzle (verwisselbaar) - BSP female



29230013

1/4"

29.85



Type AZ - messing vernikkelde Star-Tip OSHA veiligheidsnozzle - BSP female



29210013

1/4"

23.80



Type AI - zonder nozzle - 1/8" BSPT female nozzleaansluiting - BSP female



29240013

1/4"

17.75

KELM™
pneumatiek

Hydrauliek

Snel-
koppelingen

Afsluiters

Roestvast
staal

Fittingen

Lucht-
conditionering

Gereedschap

Pneumatiek

Diversen

Malleabele
fittingen
& staal

Ringleiding-
systemen

Slangen

Compressoren

Blaaspistolen



Nozzles



Type KD - standaard nozzle voor aluminium blaaspistool - M12 x 1,25 male



29000012

M12 x 1.25

1.45



Type AR - nozzle met gesinterde metalen insert - laag geluidsniveau (63-73 dB) en goede blaaseffectiviteit



29040012

M12 x 1.25

380

63-73

7.35



Type SD - veiligheidsnozzle voor aluminium blaaspistool - anti-spat en geluiddempend - M12 x 1,25 male



29010012

M12 x 1.25

11.20



Type AT - Venturi nozzle - energiebesparend en breed uitblaaseffect



29030012

M12 x 1.25

11.30



Type VR - verlengde gebogen blaaspijp voor aluminium blaaspistool - lengte 150mm



29020012

M12 x 1.25

15.20

Spatscherm



Type ST



29050000

5.20

Blaaspistool - kunststof



Temperatuur: 0°C tot +60°C



Maximale werkdruk: 10 bar



Gebogen blaaspijp - BSP female



CB01-100GF

1/4"

8.75



Rechte blaaspijp - BSP female



CB01-200GF

1/4"

200

11.25

CB01-300GF

1/4"

300

12.10

ASG-1 veiligheidsblaaspistool



Temperatuur:
0°C tot 60°C



Maximale werkdruk:
10 bar

Materiaal: huis: verchromde zinklegering.
nozzle: OSHA-USA messing.
handgreep: verchromd staal met vinyl cover.



Met nozzle



29090013



1/4"



310



9.50



OSHA veiligheidsstandaard: waarschuwing - perslucht kan niet worden gebruikt voor schoonmaak-/reinigingsdoeleinden mits de werkdruk gereduceerd is naar minder dan 30 psi (2 bar) en in combinatie met effectieve persoonlijke beschermingsmiddelen.

ASG-1 veiligheidsblaaspistool - accessoires

• Tot 33% verhoging van het luchtvolume, maar voldoet alsnog aan OSHA veiligheidsstandaard

NEW

Safety Booster nozzle

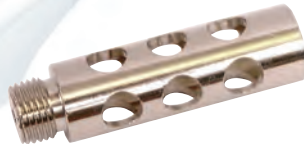

BLAA



ST11

7.20

- Geen veiligheidsnozzle
- Voor gevoelige oppervlakken die door het gebruik van messing nozzles kunnen beschadigen

NEW

Rubber nozzle



BLAA



SAT13

4.50

NEW

Verlengde nozzle

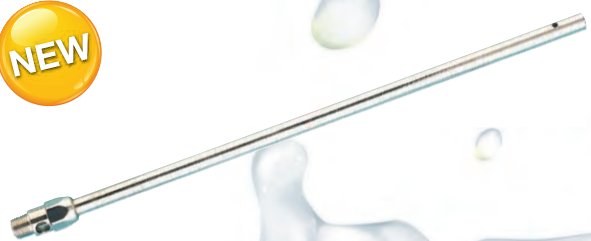

BLAA



BLAA	L	L mm	€
ST203	3"	76	9.60
ST206	6"	152.4	9.85
ST208	8"	203.2	12.40
ST210	10"	254.0	14.75
ST212	12"	304.8	15.30
ST216	16"	406.4	24.65
ST218	18"	457.2	33.05
ST224	24"	609.6	27.45
ST230	30"	762.0	30.70
ST236	36"	914.4	36.90

KELMK™
pneumatiek

Hydrauliek

Snel-
koppelingen

Afsluiters

Roestvast
staal

Fittingen

Lucht-
conditionering

Gereedschap

Pneumatiek

Diversen

Malleabele
fittings
& staal

Ringleiding-
systemen

Slangen

Compressoren

Blaaspistolen

Blaaspistool - kunststof

 **Temperatuur:**
0°C tot 60°C

 **Maximale
werkdruk:**
10 bar



AIRPRO

Gebogen blaaspijp - BSP female

29120013 1/4" 280 6.05





 **Maximale
werkdruk:**
6 bar

 **Huis:** ABS
Nozzle: Staal



AIRPRO

Gebogen blaaspijp - BSP female

			
LD04-1	1/4"	100	6.55
LD10-1	1/4"	250	10.00
LD13-1	1/4"	330	11.00
LD20-1	1/4"	500	13.05
LD40-1	1/4"	1000	18.35

Blaaspistool - aluminium





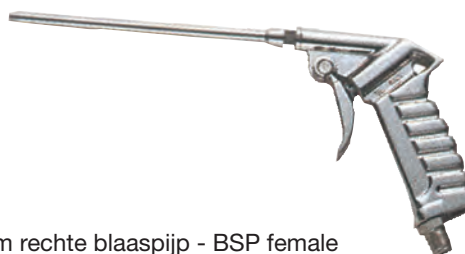

Met nozzle - BSP female

29101300 1/4" 300 11.65



150mm rechte blaaspijp - BSP female

29111300 150 1/4" 300 15.40

Materiaal huis: geanodiseerd aluminium.
Medium: lucht, water & reinigingsmiddel

 **Temperatuur:**
0°C tot 60°C

 **Maximale
werkdruk:**
10 bar



AIRPRO

Met nozzle - BSPT male

29130013 1/4" 350 11.95

Heavy duty blaaspistool - messing

Materiaal huis: messing
Medium: lucht en water

 **Maximale
werkdruk:**
10 bar

AIRPRO



Met nozzle

BG-718 1/4" 12.55

Blaaspistolen

Airsaver mini blaaspistool



Maximale
werkdruk:
6 bar



BSP female



29051300

1/4"

280

15.85

Profi blaaspistool



Maximale
werkdruk:
6 bar



150mm gebogen blaaspijp - BSP male draaibaar



29151300

Doseerpistool

1/4"

50-250

20.55

Professionele kitspuit

Aluminium - inclusief 3
verschillende messing
vernikkelde nozzles



50253A

1,02

2-5

137.65

Waspistool

Pistool: aluminium
Onderbeker: geverfd staal, 1000cc
Nozzle: messing



Maximale
werkdruk:
2-8 bar

Verstelbare nozzle



2900507

300

22.60

Pistool: aluminium
Onderbeker: aluminium, 1000cc met grote vulopening
Nozzle: messing



Maximale
werkdruk:
2-8 bar

Verstelbare nozzle



2900510

300

25.55



Air Jet nozzle

Toepassing:

- Drogen en/of verwijderen van vloeibare film van oppervlaktes
- Beheersen van oppervlaktecoating
- Afblazen en/of verwijderen van stof en vuil
- Koelen of verwijderen van materialen
- Scheiden van verschillende maten en gewichten

BSP male

AFFN-1/4	1/4"	Aluminium	4.60
PFFN-1/4	1/4"	Kunststof	2.25



Hoofdstuk 8 - Gereedschap

KELM™ pneumatiek
 Hydrauliek
 Snelkoppelingen
 Afsluiters
 Roestvast staal
 Fittingen
 Luchtconditionering
Gereedschap
 Pneumatiek
 Diversen
 Malleabele fittingen & staal
 Ringleidingssystemen
 Slangen
 Compressoren

491



MultiFLOW

– The Professional's Must-Have Air & Fluid Gun



Flow lucht:
200-1200 l/min

Flow vloeistof:
5-25 l/min

Barstdruk:
64 bar

Materiaal:
POM, TPE & aluminium

Dichting:
NBR (nitril)

Media:
Lucht en vloeistoffen
op waterbasis

Genoemde flow capaciteit is
gemeten bij een inlaatdruk van 6 bar



Temperatuurbereik bij 16 bar: -20°C tot +60°C
Temperatuurbereik bij 10 bar: -20°C tot +80°C



Maximale werkdruk:
16 bar

CEJN 320 insteeknippel aansluiting



112100400



320 insteek



74.35

Gardena insteeknippel aansluiting



112100430



Gardena



79.65

1/4" female aansluiting



112100450



1/4"



74.35

Blaaspistolen



Het universele modulaire systeem

Temperatuur: -20°C tot +60°C



Huis: POM
Blaaspijp: Messing vernikkeld

Serie 208 blaaspistool

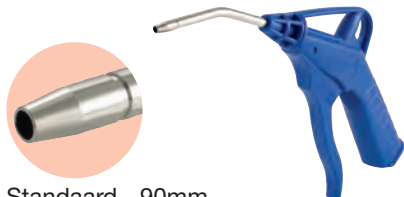

Standaard - 90mm gebogen blaaspijp - BSP female

112080100	1/4"	500	16	24.75

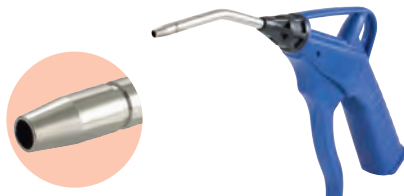

Standaard - 90mm blaaspijp (verwisselbaar) - BSP female

112080200	1/4"	500	16	25.85



Regelbaar - 90mm blaaspijp (verwisselbaar) - BSP female

112080300	1/4"	250	8	50.90



Geluidgedempt - 90mm gebogen blaaspijp met Star-Tip OSHA veiligheidsnozzle (verwisselbaar) - BSP female

112083200	1/4"	190	16	28.60



Geluidgedempt - 90mm gebogen blaaspijp met Star-Tip OSHA veiligheidsnozzle - BSP female

112083100	1/4"	190	16	25.90



Standaard - zonder blaaspijp - BSP female

112080000	1/4"	500	19.85

Serie 208 blaaspijp



Standaard - 90mm gebogen blaaspijp

112080215	90	500	6.40

Geluidgedempt - 90mm gebogen blaaspijp met Star-Tip OSHA veiligheidsnozzle

112083215	90	190	10.95



Flexibel - 400mm blaaspijp - op deze blaaspijp kunnen geen nozzles worden gemonteerd

112080222	400	120	46.55

Serie 208 spatscherm



Spatscherm - diameter 100mm

112089955	Nitriël	100	9.85

Serie 208 nozzles



Afneembaar - flexibel kliksysteem - eenvoudig te verwisselen

112089956	Rubber 14mm dia.	300	13.10
112089957	Rubber 25mm dia.	300	15.35
112089958	Rubber 34mm dia.	300	16.70
112089954	Side curtain	500	15.65

Side curtain nozzle: creëert een beschermend luchtgordijn zodat het weggeblazen materiaal zoveel mogelijk van u af beweegt. Veilig werken!



Niet afneembaar - vast kliksysteem - eenmalig op de blaaspijp te monteren

112089951	By-pass nozzle	500	14.35
112089952	Geluiddempende nozzle	370	14.35
112089953	Venturi nozzle	500	14.35

By-pass nozzle: ontluicht via zijuitgangen bij blokkade
Venturi nozzle: omgevingslucht wordt gebruikt voor toename tot 100% van de flow

Bandenpompen

Standaard bandenpomp



Maximale werkdruk:
1-6 bar



Slang 80cm - manometer Ø-63 - 0-10 bar



2900503

1/4"

250

33.75

CEE gekeurde bandenpomp



Maximale werkdruk:
1-6 bar



Slang 80cm - manometer Ø-63 - 0-10 bar



2900502

1/4"

250

46.30

CEE gekeurde bandenpomp - vrachtwagen



Maximale werkdruk:
1-6 bar



Slang 80cm - manometer Ø-63 - 0-10 bar - dubbelzijdige pompnippel (30cm)



2900505

1/4"

300

70.85

Beschermrubber voor manometer



Ø 63mm



15022063

8.25

3-delige pompnippelset



Voor boot, fiets en voetbal - blister



2900504

50-250

11.15

Bandenpompnippel

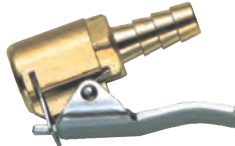

6mm slangpilaar



2900506

6.05

Dubbelzijdige pompnippel - vrachtwagen



Lengte 30cm - 6 en 8mm slangpilaar



2900501

22.50

Standaard bandenpomp



Slang 50cm - manometer Ø-63 & 80 - 0-12 bar



150120-134

1/4"

63

83.90

150130-134

1/4"

80

93.60

CEE gekeurde bandenpomp



Slang 50cm - manometer Ø-80 - 0-12 bar - CEE 86/217/EØF



150102-134

1/4"

80

255.25

Standaard bandenpomp - vrachtwagen



Slang 50cm - manometer Ø-63 & 80 - 0-12 bar - dubbelzijdige pompnippel



150123-134

1/4"

63

110.60

150131-134

1/4"

80

121.50

Heavy duty bandenpomp

Lengte slang: 85cm

Toepassing: Vrachtwagen, auto, fiets, motor



Maximale werkdruk:
15 bar



Manometer Ø-90



LB2000

1/4"

51.65

Huis: Verzinkt staal en aluminium

Zeer stootvast

Slang: Rubber

Slanglengte: 33cm

Tech Data
1948



Benzinepompmodel - 0-10 bar



LZN313

1/4"

91.40

Digitale bandenpomp

Huis: Verzinkt staal

Slang: Rubber

Slanglengte: 33cm

Dubbelzijdige nippel met W/kwik batterij

Meetbereik:

0,34 tot 13,6 bar



Manometer Ø-63



LEDT102

1/4"

75.90

Huis: Verzinkt staal

Slang: Rubber

Slanglengte: 33cm

Dubbelzijdige nippel met W/kwik batterij

Meetbereik:

0,34 tot 8,1 bar

Automatische uitschakeling na 45 seconden zonder gebruik



Manometer Ø-50



LEDT103

1/4"

55.90

Huis: Kunststof

Met W/kwik batterij

Ergonomische handgreep

Meetbereik:

0,34 tot 8,1 bar



Manometer Ø-50



LEDT104

1/4"

52.50

KELM™
pneumatiek

Hydrauliek

Snel-
koppelingen

Afsluiters

Roestvast
staal

Fittingen

Lucht-
conditionering

Gereedschap

Pneumatiek

Diversen

Malleabele
fittingen &
staal

Ringleiding-
systemen

Slangen

Compressoren

Snijringkoppelingen LL



Maximale werkdruk: 100 bar
Geschikt voor olie en smeertoepassingen



Rechte inschroefkoppeling -
staal verzinkt

0382



LU-1130	4	M6 x 1	5.40
LU-1140	4	M8 x 1	5.40
LU-1150	4	M10 x 1	5.40
LU-1160	4	1/8"	5.40
LU-1170	6	M6 x 1	4.25
LU-1180	6	M8 x 1	4.25
LU-1190	6	M10 x 1	4.25
LU-1200	6	1/8"	4.25
LU-1210	6	1/4"	8.95

RVS



Rechte inschroefkoppeling -
RVS AISI-304

0382



LU-1220SS	6	M6 x 1	27.65
LU-1230SS	6	M8 x 1	27.70
LU-1240SS	6	M10 x 1	27.70
LU-1250SS	6	1/8"	27.70



Knie inschroefkoppeling -
staal verzinkt

0382



LU-1000	4	M6 x 1	8.85
LU-1010	4	M8 x 1	8.85
LU-1020	4	M10 x 1	8.85
LU-1030	4	1/8"	8.85
LU-1040	6	M6 x 1	8.85
LU-1050	6	M8 x 1	8.85
LU-1060	6	M10 x 1	8.85
LU-1070	6	1/8"	8.85
LU-1080	6	1/4"	14.35

RVS



Knie inschroefkoppeling -
RVS AISI-304

0382



LU-1090SS	6	M6 x 1	18.00
LU-1100SS	6	M8 x 1	34.70
LU-1110SS	6	M10 x 1	34.70
LU-1120SS	6	1/8"	34.70



Rechte koppeling - staal verzinkt

0382



LU-1260	4	9.20
LU-1270	6	7.40

RVS



Rechte koppeling - RVS AISI-304

0382



LU-1290SS	6	33.80
-----------	---	-------



Wartelmoer - staal verzinkt

0382



LU-1300	4	1.00
LU-1310	6	1.00

RVS



Wartelmoer - RVS AISI-304

0382



LU-1340SS	6	9.85
-----------	---	------



Snijring - staal verzinkt

0382



LU-1320	4	0.90
LU-1330	6	0.90

RVS



Snijring - RVS AISI-304

0382



LU-1350SS	6	6.50
-----------	---	------

Brandstofapparatuur



Vatpomp

Gietijzeren handpomp met vuilvanger en 2" BSP vat aansluiting. Voor olie en benzine.

Tech Data
1172



Manueel - 2" adapter en 1 meter zuigpijp



2042-5658



Tot 25 l/min



47.80

Sifonpomp

Geschikt voor het pompen van de meeste vloeistoffen: zuren, alkaline, antivries, ontvetter, gedistilleerd water, diesel, benzine, lichte oliën en oplossingen.



Manueel



HPS25
HPS205



Voor 5-25 liter vat
Voor 205 liter vat



6.85
29.40

Smeerapparatuur

CISSON

Vetspuitslang



Maximale werkdruk:
400 bar
Barstdruk:
900 bar



Rubber slang met staalinlage -
BSP male



2017-3654
2017-3662



1/8"



300mm (12")
450mm (18")



6.40
7.65



Maximale werkdruk:
400 bar
Barstdruk:
900 bar



Polyamide gecoate slang met nylon
textielinlage - BSP male



2017-3670
2017-3688



1/8"



300mm (12")
450mm (18")



5.80
6.40



Vast verlengstuk met
4-beks mondstuk



2017-3720



10.70

Vetpatroon

Multi purpose lagervet voor
conventionele toepassingen.



Lithium No.2



2017-6780



400



5.45

Smeernippels

80-delige assortimentsbox met rechte
smeernippels en bochtstukken



NEW

Assortimentsbox - 80 stuks



J9130/80
J9131/80



BSP/BSF/UNF
M6/M8/M10



63.85
63.85

KELM™
pneumatiek

Hydrauliek

Snel-
koppelingen

Afsluiters

Roestvast
staal

Fittingen

Lucht-
conditionering

Gereedschap

Pneumatiek

Diversen

Malleabele
fittingen
& staal

Ringleiding-
systemen

Slangen

Compressoren

Kegelsmeernippel



Bochtstuk - DIN 71412 - BSPT male

0088			€
2017-3829	45ø	1/8"	1.20
2017-3845	45ø	1/4"	2.25
2017-3811	65ø	1/8"	0.90
2017-3787	90ø	1/8"	1.20
2017-3795	90ø	1/4"	2.25



Recht - DIN 71412 - BSPT male

0088		€
2017-3738	1/8"	0.70
2017-3746	1/4"	1.40

Vlakmeernippel 16mm



Zeskantkop (15mm A/F) - DIN 3404 - BSP male

0088		€
2017-3860	1/8"	1.05
2017-3878	1/4"	1.20



Ronde kop - DIN 3404 - BSP male

0088		€
2017-3886	1/8"	1.05
2017-3894	1/4"	1.20

Mondstuk

Voor gebruik met kegelsmeernippels DIN 71412. Bekjes van gehard staal voor een langere levensduur.



0088		€
2017-3621	37 (met klep)	6.25
2017-3639	37 (zonder klep)	4.35

Voor gebruik met vlakmeernippels (ronde en zeskantkop).



0088	€
2017-3647	10.50

Voor gebruik met vlakmeernippels (ronde en zeskantkop).



0088	€
2017-3696	10.50

Voor gebruik met vlakmeernippels (ronde en zeskantkop).



0088	€
2017-3712	18.15

Vetspuiten

- Universele spuit voor gebruik met 400cc cartridges of 500cc bulk vet



BLAA	€
2017-3506	20.35

- Universele spuit voor gebruik met 400cc cartridges of 500cc bulk vet
- Vaste uitloop en borgmoer, 4-bekks connector & vul- en ontluchtingsnippel



0088	€
2017-3514	61.05

- Universele spuit voor gebruik met 400cc cartridges of 500cc bulk vet
- Vaste tuit en borgmoer, 4-bekks connector



0088	€
2017-3555	48.20

- Universele spuit voor gebruik met 400cc cartridges of 500cc bulk vet
- Maximale druk 10 bar
- Luchtinlaat 1/4" BSP female



0088	€
2020-7312	47.15

Verfspuiten

Verfspuit

Toepassing: algemene toepassingen in automotive, bouw, hobby, industrie en scheepsbouw



Belangrijk! Na gebruik zeer grondig reinigen.

Materiaal:

- Nozzle:** 1.8mm
- Aansluiting:** 1/4" male
- Slangadvies:** Min. doorlaat 3/8" = 9.5mm
- Flow systeem:** Suction
- Onderbeker:** aluminium 1000 cc met camlock snelsluiting
- Lucht L/mm:** Gemiddeld 10 cfm. = 280 L/min

Temperatuur:
Advies +20°C tot 30°C



Type W-97 - 3.5-5 bar - aluminium 1000cc onderbeker



W-97

280

94.55

Geschikt voor alle soorten verf. Eenvoudig te bedienen en te reinigen. Unieke inlaat flowregelaar.



Belangrijk! Na gebruik zeer grondig reinigen.

Materiaal:

- Regelnaald:** messing
- Huis:** vernikkeld aluminium
- Bovenbeker:** nylon 680 cc
- Nozzle:** standaard 1,5mm



Type Prima - 2-3.5 bar - nylon 680cc bovenbeker



2900511

80-200

48.80

Professionele verfspuit

Voor alle soorten verf. Eenvoudig te bedienen en te reinigen. Met grote interne doorlaat waardoor beter fijnregeling bij een relatief lage druk mogelijk is.



Belangrijk! Na gebruik zeer grondig reinigen.

Materiaal:

- Regelnaald:** messing
- Nozzle:** 1,4mm. compleet met regelnaald
- Bovenbeker:** nylon 680 cc



Type UR/S PLUS - 3-3.5 bar - nylon 680cc bovenbeker



2900529

180-330

74.50



Nozzle set voor verfspuit type UR/S PLUS



2900117S

Nozzle-Sup.ex/MS 1.7mm

36.95

2900122S

Nozzle-Sup.ex/MS 2.2mm

36.95

Voor snelkoppelingen
zie hoofdstuk 3



KELM™
pneumatiek

Hydrauliek

Snel-
koppelingen

Afsluiters

Roestvast
staal

Fittingen

Lucht-
conditionering

Gereedschap

Pneumatiek

Diversen

Malleabele
fittingen &
staal

Ringleiding-
systemen

Slangen

Compressoren

Verfspuiten

Professionele verfspuit

Industriële verfspuit voor alle soorten verf. Eenvoudig te bedienen en te reinigen. Met grote interne doorlaat waardoor beter fijnregeling bij een relatief lage druk mogelijk is.



Belangrijk! Na gebruik zeer grondig reinigen.

Materiaal:

Regelnaald: messing

Nozzle: 1,7mm compleet met regelnaald

Onderbeker: Aluminium 1000 cc



Type UR-Plus-1000 - 3-4.5 bar - aluminium 1000cc onderbeker



2900509

200-350

99.80

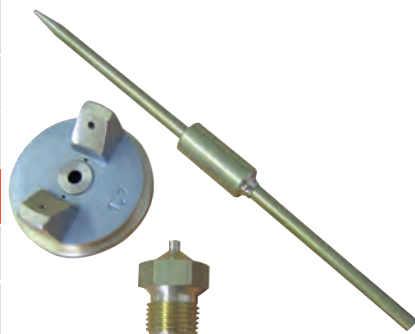

Nozzleset voor verfspuit type UR-Plus-1000



2900114

Nozzle-SUP.EX/MS 1.4mm

37.85

2900119

Nozzle-SUP.EX/MS 1.9mm

37.85

2900122

Nozzle-SUP.EX/MS 2.2mm

37.85

2900130

Nozzle-SUP.EX/MS 3mm

37.85

Industriële verfspuitkit

Geschikt voor alle soorten verf. Bijzonder geschikt voor verven op waterbasis. Dit innovatieve professionele verfpistool is voorzien van het HVLP (High Volume, Low Pressure) energiebesparende lagedruk systeem. Hierdoor werkt het pistool zeer goed bij een relatief lage druk, waardoor minder verf verloren gaat.

Gebruikt minder energie, werkt kostenbesparend en is minder milieubelastend.

Ergonomisch lichtgewicht ontwerp.

Inclusief manometer. Punt- of vlakstraal instelbaar. Zeer goede fijnregeling.



Belangrijk! Na gebruik zeer grondig reinigen.

Materiaal:

Spuitmond: RVS-AISI-303

Fijnregelnaald: RVS-AISI-303

Veren: RVS

Seals: PTFE

Huis: chemisch vernikkeld aluminium

Bovenbeker: nylon 680 cc

Nozzle: standaard 1,5mm

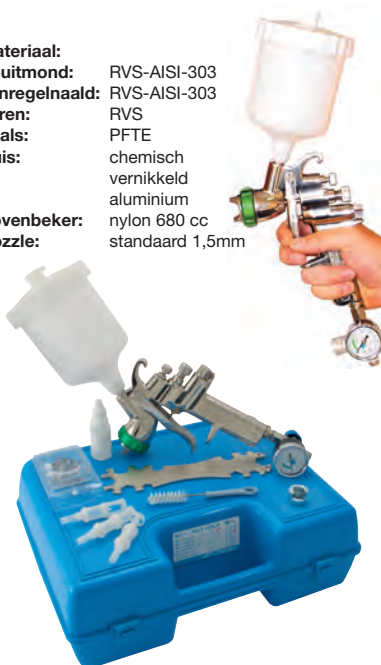

Type 9011 HVLP - 2 bar - nylon 680cc bovenbeker - inclusief drukregelaar met manometer, koffer en div. onderdelen



2900530

200-270

251.05

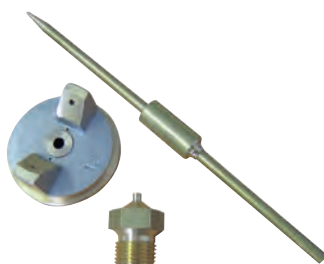

Nozzleset voor verfspuit type 9011 HVLP



2900215

Nozzle-RVS/SET-530-1.5mm

82.85

2900217

Nozzle-RVS/SET-530-1.7mm

82.85

2900219

Nozzle-RVS/SET-530-1.9mm

82.85

Materiaal:

Spuitmond: RVS-AISI-303.

Fijnregelnaald: RVS-AISI-303.

Veren: RVS.

Seals: PTFE.

Huis: chemisch vernikkeld aluminium.

Onderbeker: aluminium gecoat

1000 cc. met camlock snelsluiting.

standaard 1,7 mm.

Nozzle:



Type 9010 HVLP - 2 bar - aluminium 1000cc onderbeker - inclusief drukregelaar met manometer, koffer en div. onderdelen



2900532

301.80

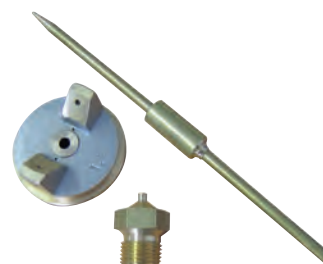

Nozzleset voor verfspuit type 9010 HVLP



2900415

Nozzle-RVS/SET-532-1.5mm

88.10

2900417

Nozzle-RVS/SET-532-1.7mm

88.10

2900419

Nozzle-RVS/SET-532-1.9mm

88.10



Hogedrukreiniging

Tech Data
3105

• Olie-, slijtage-, ozon- en weerbestendig synthetisch gepinrikt rubber.
Staaldraadinlagen met hoge treksterkte.

Jetwash hogedrukslang - blauw



1 staaldraad inlage - 10 meter rol

0303				
PWBLUE-04-10-R1	900	225	1/4"	38.80
PWBLUE-05-10-R1	860	215	5/16"	47.40
PWBLUE-06-10-R1	720	180	3/8"	65.70

1 staaldraad inlage - 25 meter rol

0303				
PWBLUE-04-25-R1	900	225	1/4"	147.30
PWBLUE-05-25-R1	860	215	5/16"	180.00
PWBLUE-06-25-R1	720	180	3/8"	212.50

2 staaldraad inlagen - 100 meter rol

0303				
PWBLUE-04-100-R2	1600	400	1/4"	742.30
PWBLUE-05-100-R2	1400	350	5/16"	978.75
PWBLUE-06-100-R2	1320	330	3/8"	1117.35

Slangpilaar



M22x1,5 female

0303	Size		
JWF-22-04	DN6	1/4"	3.65
JWF-22-05	DN8	5/16"	2.95
JWF-22-06	DN10	3/8"	3.85

Jetwash hogedrukslang - zwart



1 staaldraad inlage - 10 meter rol

0303				
PWBLACK-04-10-R1	900	225	1/4"	58.60
PWBLACK-05-10-R1	860	215	5/16"	73.35
PWBLACK-06-10-R1	720	180	3/8"	84.10

1 staaldraad inlage - 25 meter rol

0303				
PWBLACK-04-25-R1	900	225	1/4"	141.15
PWBLACK-05-25-R1	860	215	5/16"	172.10
PWBLACK-06-25-R1	720	180	3/8"	203.20

2 staaldraad inlagen - 100 meter rol

0303				
PWBLACK-04-100R2	1600	400	1/4"	703.50
PWBLACK-05-100R2	1400	350	5/16"	876.10
PWBLACK-06-100R2	1320	330	3/8"	1009.95

Knikbeschermers

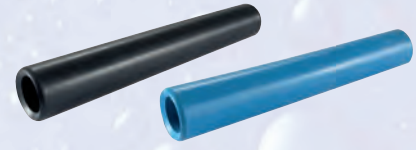

Geschikt voor 3/8" slang (1 of 2 staaldraad inlagen)

0303		To Suit Hose I.D.	
3/8-BLUE-CUFF	Blauw	3/8"	0.90
3/8-BLACK-CUFF	Zwart	3/8"	0.95

Jetwash hogedrukslang - geassembleerd



- Olie-, slijtage-, ozon- en weerbestendig synthetisch gepinrikt rubber. Staaldraadinlagen met hoge treksterkte.
- Speciaal synthetisch rubber voor hoge temperaturen.
- Blauwe slang is geschikt voor omgevingen waar non-marking slang een vereiste is (zoals zuivelomgeving)
- Zwarte slang is geschikt voor standaard reinigingstoepassingen (zoals autowasstraat)

10 meter 2 staaldraad inlagen 3/8 ID - M22x1,5 female

0303					
2PWLA-K-K-38B	Blauw	1320	330	3/8"	128.60
2PWLA-K-K-38N	Zwart	1320	330	3/8"	119.00

10 meter 2 staaldraad inlagen 3/8 ID - M22x1,5 female x 3/8" BSP female

0303					
2PWLA-K-F-38B	Blauw	1320	330	3/8"	90.55
2PWLA-K-F-38N	Zwart	1320	330	3/8"	86.75

10 meter 2 staaldraad inlagen 3/8 ID - M22x1,5 female x 3/8" BSP male



0303					
2PWLA-K-M-38B	Blauw	1320	330	3/8"	125.80
2PWLA-K-M-38N	Zwart	1320	330	3/8"	87.30

JAYMAC

Industrial Hose & Accessories

- Inlaat: 1/2" BSP
- Automatische uitschakeling
- Instelbaar spuitpatroon
- Het rubber geïsoleerde huis en greep laat geen strepen of krassen achter
- Vergrendelbare trekker
- Niet geschikt voor gebruik met stoom

1/2" BSP female inlaat

1369				€
WASH-GUN	1/2"	25	Blauw Rood	42.80
REDWASH-GUN	1/2"	25	Rood	43.40

 **Temperatuur:** +50°C

 **Maximale werkdruk:** 25 bar



Heavy Duty messing spuitpistolen

Heavy Duty RVS

hygiënische spuitpistolen

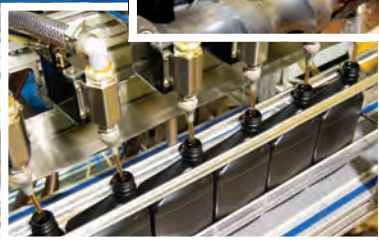

- Inlaat: 1/2" BSP female
- Automatische uitschakeling
- Instelbaar spuitpatroon
- Het rubber geïsoleerde huis en greep laat geen strepen of krassen achter
- Vergrendelbare trekker

1/2" BSP female inlaat

1369	BSPP	bar		€
HYGWASH-GUNR	1/2"	25	Rood	120.40
HYGWASH-GUNG	1/2"	25	Groen	120.40
HYGWASH-GUN	1/2"	25	Wit	120.40



Temperatuur:
+90°C



Maximale
werkdruk:
25 bar

SPUITPISTOLEN MET LANS

- Inlaat: 3/8" BSP
- Maximale flow: 25 l/min
- Dichte isolatie
- Nozzlehouder en beschermer
- 25° spuitpatroon
- Diverse lanslengtes

Temperatuur: 150°C
 Maximale werkdruk: Max. 250 bar

Rechte lans - 3/8" BSP inlaat

1369

 €

PRESSURE-LANCE 3/8" 900 250 45.95

15° gebogen lans - 3/8" BSP inlaat

1369

 €

PRESSURE-LANCE15 3/8" 900 250 59.65

Rechte korte lans - 3/8" BSP inlaat

1369

 €

PRESSURE-LANCESH 3/8" 430 250 59.00

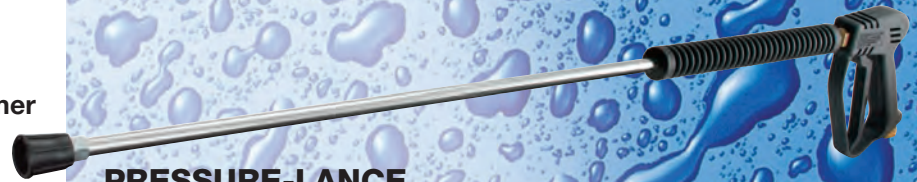

PRESSURE-LANCE

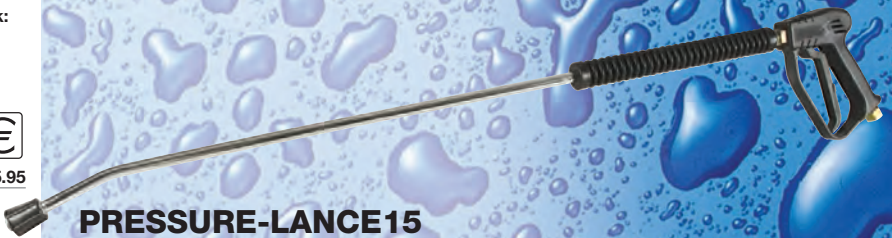

PRESSURE-LANCE15



PRESSURE-LANCESH

- Inlaat: 3/8" BSP
- Maximale flow: 40 l/min
- Open of dichte isolatie
- Nozzlehouder en beschermer
- 25° spuitpatroon
- 900mm lans
- Verstelbare lage-/hogedruknozzle
- Extra handgreep zorgt voor meer controle

Temperatuur: 150°C
 Maximale werkdruk: Max. 280 bar

Rechte lans - dichte isolatie - 3/8" BSP inlaat

1369

 €

CD-2502 3/8" 900 280 85.90

Rechte lans - open isolatie - 3/8" BSP inlaat

1369

 €

CD-2501 3/8" 900 280 87.55

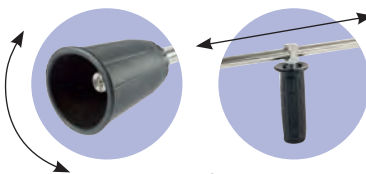

Verstelbaar

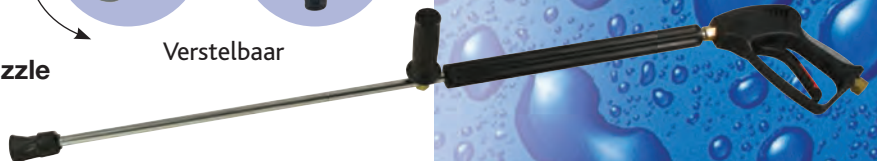

CD-2502



CD-2501

Hogedrukreiniging



Spuitpistolen met lans

FLOW 40 l/min



Rechte korte lans - hoge flow - 3/8" BSP inlaat

1369 **BSPP** **L** **bar** **€**
PWLA1 3/8" 400 250 76.60

FLOW 40 l/min



Rechte lans - hoge flow - BSP inlaat - 3/8" BSP inlaat

1369 **BSPP** **L** **bar** **€**
PWLA2 3/8" 900 250 73.50

FLOW 25 l/min

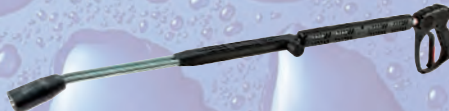

Gebogen dubbele lans - lage flow - 3/8" BSP inlaat

1369 **BSPP** **L** **bar** **€**
PWLA3 3/8" 1060 280 95.45

FLOW 40 l/min

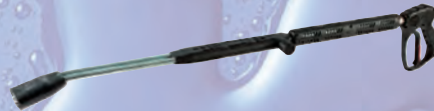

Gebogen dubbele lans - hoge flow - 3/8" BSP inlaat

1369 **BSPP** **L** **bar** **€**
PWLA4 3/8" 1060 250 94.50

FLOW 25 l/min

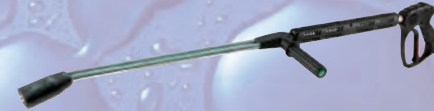

Gebogen dubbele lans met handgreep - lage flow - 3/8" BSP inlaat

1369 **BSPP** **L** **bar** **€**
PWLA5 3/8" 1060 280 89.95

FLOW 40 l/min



Gebogen dubbele lans met handgreep - hoge flow - 3/8" BSP inlaat

1369 **BSPP** **L** **bar** **€**
PWLA6 3/8" 1060 250 107.70

Algemene max. temperatuur: 150°C

Samengesteld spuitpistool met 900mm verzinkte rechte lans. Inclusief dicht isolatiedeel, nozzlehouder en beschermer.

FLOW 40 l/min



Rechte lans - hoge flow en hogedruk - 3/8" BSP inlaat

1369 **BSPP** **L** **bar** **€**
1002-0038 3/8" 900 310 83.95

Hogedruknozzles



1/4" NPT male

MTWK		bar	@50bar LPM	@100bar LPM	@150bar LPM	€
HPN3015	15° Straal	500	5.3	6.8	8.3	13.85
HPN3515	15° Straal	500	6	7.8	9.5	13.85
HPN4015	15° Straal	500	7.3	9.4	11.5	13.85
HPN4515	15° Straal	500	7.1	10.2	12.2	13.85
HPN5015	15° Straal	500	8.7	11.3	13.8	13.85
HPN5515	15° Straal	500	9.6	12.4	15.2	13.85
HPN6015	15° Straal	500	10.4	13.6	16.7	13.85
HPN6515	15° Straal	500	11.3	14.7	17.4	13.85
HPN3025	25° Straal	500	5.3	6.8	8.3	13.85
HPN3525	25° Straal	500	6	7.8	9.5	13.85
HPN4025	25° Straal	500	7.3	9.4	11.5	13.85
HPN4525	25° Straal	500	7.1	10.2	12.2	13.85
HPN5025	25° Straal	500	8.7	11.3	13.8	13.85
HPN5525	25° Straal	500	9.6	12.4	15.2	13.85
HPN6025	25° Straal	500	10.4	13.6	16.7	13.85
HPN6525	25° Straal	500	11.3	14.7	17.4	13.85

Hogedruk watersnelkoppeling

Maximale werkdruk: 210 bar

Uitwisselbaar met: Nito hogedruk watersnelkoppelingen 40 serie watersnelkoppelingen



Snelkoppeling - BSP female

1369 **€**
PWQRC-38 3/8" 16.40



Insteeknippel - BSP female

1369 **€**
PWQRP-38 3/8" 7.95



Spuitpistolen met lans

FLOW 25 l/min

RVS

Gebogen dubbele RVS lans - lage flow - 3/8" BSP inlaat

1369 **BSPP** **bar** €

PWLA7 3/8" 280 132.25

FLOW 40 l/min

RVS

Gebogen dubbele RVS lans - hoge flow - 3/8" BSP inlaat

1369 **BSPP** **bar** €

PWLA8 3/8" 250 145.10

FLOW 25 l/min

RVS

Gebogen dubbele RVS lans met handgreep - lage flow - 3/8" BSP inlaat

1369 **BSPP** **bar** €

PWLA9 3/8" 280 139.45

FLOW 40 l/min

RVS

Gebogen dubbele RVS lans met handgreep - hoge flow - 3/8" BSP inlaat

1369 **BSPP** **bar** €

PWLA10 3/8" 250 133.55

Hogedrukpistolen

Max. temperatuur: 150°C

Max. werkdruk: 280 bar

3/8" BSP inlaat - 30 l/min

1369 **Inlet** **Outlet** €

ST900 3/8" 1/4" 27.50

Max. temperatuur: 150°C

Max. werkdruk: 280 bar

Soft grip - 3/8" BSP inlaat - 40 l/min

1369 **Inlet** **Outlet** €

CDQ1500 3/8" 1/4" 43.40

Max. temperatuur: 100°C

Max. werkdruk: 190 bar

3/8" BSP inlaat - 32 l/min

1369 **Inlet** **Outlet** €

ST-2 3/8" 1/4" 36.10

Max. temperatuur: 150°C

Max. werkdruk: 310 bar

3/8" BSP inlaat - 30 l/min

1369 **Inlet** **Outlet** €

ST-5 3/8" 1/4" 32.00

Max. temperatuur: 150°C

Max. werkdruk: 280 bar

3/8" BSP inlaat - 25 l/min

1369 **Inlet** **Outlet** €

CDQ1900 3/8" 1/4" 39.30

Max. temperatuur: 150°C

Max. werkdruk: 345 bar

In-line - 3/8" BSP inlaat - 45 l/min

1369 **Inlet** **Outlet** €

CDQ2100 3/8" 1/4" 53.95

Max. temperatuur: 150°C

Max. werkdruk: 345 bar

3/8" BSP inlaat - 45 l/min

1369 **Inlet** **Outlet** €

CDQ1600 3/8" 1/4" 47.60

KELM™
pneumatiek

Hydrauliek

Snel-
koppelingen

Afsluiters

Roestvast
staal

Fittingen

Lucht-
conditionering

Gereedschap

Pneumatiek

Diversen

Malleabele
fittings &
staal

Ringleiding-
systemen

Slangen

Compressoren

Spuitlansen

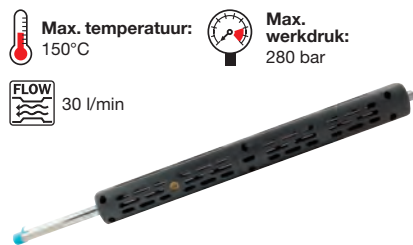

Rechte lans - open isolatie - 1/4" BSPT inlaat/uitlaat

1369		€
BD-20	500	15.15
BD-25	635	16.30
BD-30	760	17.65
BD-36	900	19.50



Gebogen lans - open isolatie - 1/4" BSPT inlaat/uitlaat

1369		€
CDBB-20	500	15.15
CDBB-25	635	16.65
CDBB-30	760	17.95
CDBB-36	900	19.85



Rechte lans - dichte isolatie - 1/4" BSPT inlaat/uitlaat

1369		€
BMG-20	500	10.55
BMG-25	635	11.95
BMG-30	760	13.50
BMG-36	900	15.35

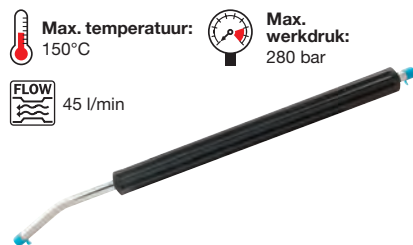

Gebogen lans - dichte isolatie - 1/4" BSPT inlaat/uitlaat

1369		€
CDBJ-20	500	12.40
CDBJ-25	635	13.85
CDBJ-30	760	15.45
CDBJ-36	900	17.35

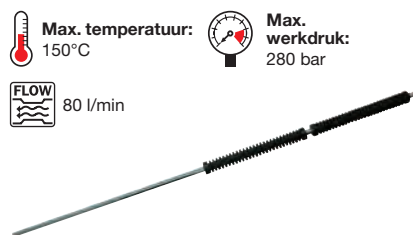

Dubbele rechte lans - dichte isolatie - 1/4" BSPT inlaat/uitlaat

1369		€
CDBU-42	1065	24.40
CDBU-47	1190	25.95
CDBU-50	1270	27.15



Dubbele gebogen lans - dichte isolatie - 1/4" BSPT inlaat/uitlaat

1369		€
CDBV-42	1065	20.45
CDBV-47	1190	22.05
CDBV-50	1270	22.90

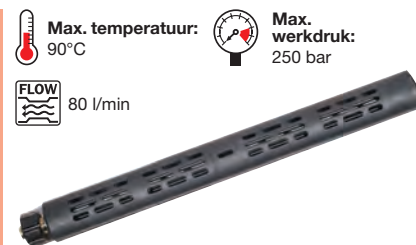

Rechte lans - open isolatie - 1/4" BSPT inlaat/M22 uitlaat

1369		€
BA-16	405	19.10
BA-18	457	19.85
BA-20	508	20.45



Rechte lans - dichte isolatie - 1/4" BSPT inlaat/M22 uitlaat

1369		€
BC-13	330	13.85
BC-15	380	14.60
BC-18	457	15.45
BC-20	508	16.05

Extensie M22 & nozzle

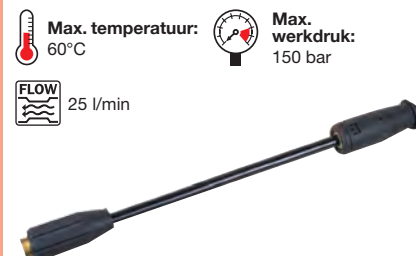

Verstelbare M22 male extensie

1369		€
CDBL-15	375	19.50

KELM™
pneumatiek

Hydrauliek

Snel-
koppelingen

Afsluiters

Roestvast
staal

Fittingen

Lucht-
conditionering

Gereedschap

Pneumatiek

Diversen

Malleabele
fittings
& staal

Ringleiding-
systemen

Slangen

Compressoren

Dubbele spuitlansen

Max. temperatuur: 60°C

Max. werkdruk: 250 bar

45 l/min



RVS

Dubbele gebogen RVS lans

1369
SSTLTC 1/4" 101.10



RVS

Dubbele gebogen RVS lans met handgreep

1369
SSTLH 1/4" 107.35



Dubbele gebogen verzinkte lans met handgreep

1369
ZPTLH 1/4" 69.50



Dubbele gebogen verzinkte lans

1369
ZPTLTC 1/4" 63.20

Spuitlansen

Standaard geleverd met 1/4" BSP female nozzlehouder & beschermer. Inlaat 1/4" BSP male.

Max. temperatuur: +150°C

Max. werkdruk: 250 bar

40 l/min



Rechte verzinkte lans - dichte isolatie

1369		No. of Grips			
SL-2	900	1	280	40	16.15



Gebogen verzinkte lans - dichte isolatie

1369		No. of Grips			
SL-3	900	1	280	40	26.10
SL-4	1200	2	280	40	37.70



Gebogen verzinkte lans - holle isolatie

1369		No. of Grips			
SL-5	700	1	280	40	30.70



Gebogen verzinkte lans - open isolatie

1369		No. of Grips			
SL-7	900	1	280	40	20.65
SL-8	900	2	280	40	40.05



RVS

Gebogen RVS lans - dichte isolatie

1369		No. of Grips			
SL-10	900	1	280	40	42.20
SL-11	1200	1	280	40	42.20



RVS

Rechte RVS lans - dichte isolatie

1369		No. of Grips			
SL-12	Schroefbev. 900	1	280	40	49.00
SL-13	Schuifbev. 900	1	280	40	23.90

Heavy duty schuimplans

- Eenvoudig aan te sluiten op een hogedrukpistool of lans
- Creëert een egale schuimplaag op het te reinigen object
- 1/4" BSP male aansluiting
- 1 liter reservoir
- Nozzle met variabele spuithoek
- Met doseerknop

Temperatuur: +60°C

Maximale werkdruk: 275 bar

BSP male

1369
FGB-1 1/4" 48.95



NEW

Nozzlehouders

Max. temperatuur: 60°C
Max. werkdruk: 250 bar

FLOW 36 l/min



Staal - 1/4" female

1369
CDH005 1/4" 3.65

Max. temperatuur: 90°C
Max. werkdruk: 250 bar

FLOW 36 l/min



Staal - 1/4" female -
verstelbaar met beschermer

1369
CDH004 1/4" 6.85

Max. temperatuur: 90°C
Max. werkdruk: 250 bar

FLOW 36 l/min



Messing - 1/4" female

1369
CDH002 1/4" 22.90

Max. temperatuur: 90°C
Max. werkdruk: 250 bar

FLOW 36 l/min



Messing - 1/4" female -
verstelbaar met beschermer

1369
CDH006 1/4" 25.95

Max. temperatuur: 90°C
Max. werkdruk: 250 bar

FLOW 36 l/min



Messing - 1/4" female - kort

1369
CDH001 1/4" 4.40

Turbo nozzles - roterend

Max. temperatuur: 90°C
Max. werkdruk: 345 bar

FLOW 45 l/min



1/4" BSP female

1369
9202L 1/4" 97.60

Max. temperatuur: 90°C
Max. werkdruk: 280 bar

FLOW 45 l/min



1/4" BSP female

1369
9203L 1/4" 70.00

Hogedruknozzles - quick release



1/4" aansluiting

1369		@50bar LPM	@100bar LPM	@150bar LPM	€
A00050	0°	8	11.3	13.8	4.40
A00055	0°	8.7	12.4	15.2	4.40
A00060	0°	9.6	13.6	16.7	4.40
A15050	15°	8	11.3	13.8	4.40
A15055	15°	8.7	12.4	15.2	4.40
A15060	15°	9.6	13.6	16.7	4.40
A25050	25°	8	11.3	13.8	4.40
A25055	25°	8.7	12.4	15.2	4.40
A25060	25°	9.6	13.6	16.7	4.40
A40050	40°	8	11.3	13.8	4.40
A40055	40°	8.7	12.4	15.2	4.40
A40060	40°	9.6	13.6	16.7	4.40

Snelkoppelingen t.b.v. serie A hogedruknozzles



BSP female

1369
CDC-14F-14M-B 1/4" 6.50



BSP male

1369
CDC-14M-14M-B 1/4" 6.50

KELM™
pneumatiek

Hydrauliek

Snel-
koppelingen

Afsluiters

Roestvast
staal

Fittingen

Lucht-
conditionering

Gereedschap

Pneumatiek

Diversen

Malleabele
fittingen
& staal

Ringleiding-
systemen

Slangen

Compressoren

Topkwaliteit componenten voor hogedrukreinigers en de autowasindustrie

Snelkoppeling

Temperatuur: 150°C

Maximale werkdruk: 250 bar

FLOW 55 L/min



Messing vernikkeld - Kew profiel - BSP female

MTMK BSPP € C390-17 3/8" 15.50

Insteeknippel



Staal verzinkt - Kew profiel - BSP female

MTMK BSPP € HPN390-17 3/8" 5.30

Temperatuur: 90°C

Maximale werkdruk: 390 bar

FLOW 55 L/min



RVS - Kew profiel - BSP female

MTMK BSPP € CSS390-17 3/8" 55.45

RVS



RVS - Kew profiel - BSP female

MTMK BSPP € HPN390-17 3/8" 14.75

Temperatuur: 150°C

Maximale werkdruk: 310 bar

FLOW 55 L/min



Messing/RVS spigot - Kew profiel - BSP male

MTMK € KEWQRC310 1/4" 39.05

RVS



Messing/RVS spigot - Kew profiel - BSP male

MTMK € KEWQN310 1/4" 25.20

Schroefsnelkoppeling

Temperatuur: 160°C

Maximale werkdruk: 280 bar

FLOW 55 L/min



Messing - BSP/metrisch female - zuiger diameter 14mm

MTMK € SQ22F17GF M22 x 1.5 - 3/8" 7.50



Messing - BSP/metrisch male

MTMK € SQ22M17GM M22 x 1.5 - 3/8" 3.80



Messing - tweedelig - BSP/metrisch female

MTMK € QS22F13F M22 x 1.5 - 1/4" 310 7.10

KELM™ pneumatiek

Hydrauliek

Snelkoppelingen

Afsluiters

Roestvast staal

Fittingen

Luchtconditionering

Gereedschap

Pneumatiek

Diversen

Malleabele fittingen & staal

Ringleidingssystemen

Slangen

Compressoren

Iride hogedruk reinigingspistolen

Topkwaliteit componenten voor hogedrukreinigers en de autowasindustrie.

Het productieproces en kwaliteitscontroletraject voldoet aan zeer hoge eisen.

De opgenomen onderdelen zijn uitwisselbaar met de meeste merken hogedrukreinigers.

Toepasbaar in autowasstraten en industriële reinigingsprocessen.

Max temperatuur:
150°C



Standaard - inlaat/uitlaat BSP female

WG280-10	3/8"	1/4"	280	30	41.20

Standaard - swivel inlaat/
BSP female uitlaat

WG280-13	3/8"	1/4"	280	30	59.55
WG280-12	M22	1/4"	280	30	59.55



Met vorstbeveiliging (continu)-
swivel inlaat/BSP female uitlaat -
lekwaarde 0.6 l/min

WG280-14	3/8"	1/4"	280	30	63.50



Met vorstbeveiliging (lagedruk -
continu) - swivel inlaat/BSP female
uitlaat - lekwaarde 0.6 l/min

WG280-16	3/8"	1/4"	280	30	73.15



Standaard - swivel inlaat/spigot KW
kogelsnelkoppeling uitlaat

WG280-17	3/8"	SK	280	30	106.45
WG280-18	M22	SK	280	30	106.45



Standaard - Kärcher M22x1.5
swivel inlaat/Kärcher M22x1.5
(dubbele O-ring) uitlaat

WG280-19	M22	M22	280	30	68.30

KELM™
pneumatiek

Hydrauliek

Snel-
koppelingen

Afsluiters

Roestvast
staal

Fittingen

Lucht-
conditionering

Gereedschap

Pneumatiek

Diversen

Malleabele
fittingen
& staal

Ringleiding-
systemen

Slangen

Compressoren

Hogedrukreiniging



Schuimlans



Met 0,5 liter onderbeker

FOAM-1	M22 x 1,5	1,85mm	0,5	39.85

Hogedruk reinigungs-slang voor buisreiniging

Max temperatuur: 150°C



8 meter - compleet met messing nozzle

H1-210	M22	280	6mm	8	85.90

RVS spuitlans (underbody) - zonder isolatie

Max temperatuur: 150°C



M22x1.5 inlaat - 1/4" NPT female uitlaat

UBL-1	M22 x 1,5	1/4"	280	1	39.85

Nozzlehouder (retainer)



Messing - versterkt kunststof (voor Kärcher spuitlans)

TIP18	M18 Fem	3.15

MT2 spuitlans - met open isolatie

Max temperatuur: 150°C



RVS lans - inlaat 1/4" BSP male - uitlaat 1/4" NPT female

LGV1-700	700	280	40	22.80
LGV1-1500	1500	280	40	38.15

Andere lengtes tot 2000 mm zijn op aanvraag leverbaar.



RVS lans - inlaat RVS spigot KW insteeknippel - uitlaat 1/4" NPT female

KEW2-700	700	280	40	46.10
KEW2-1500	1500	280	40	62.10

Andere lengtes tot 2000 mm zijn op aanvraag leverbaar.

MT3 spuitlans - met dichte isolatie

Max temperatuur: 150°C



RVS lans - inlaat 1/4" BSP male - uitlaat 1/4" NPT female

KAMT3-700	700	280	40	18.70

Andere lengtes tot 2000 mm zijn op aanvraag leverbaar.



Dubbele RVS lans - inlaat 1/4" BSP male - uitlaat 1/4" NPT female

DLMT2H-1060	1060	280	40	69.50

Dubbele spuitlans - met open isolatie en greep

Max temperatuur: 150°C



RVS lans - inlaat RVS spigot KW insteeknippel - uitlaat 1/4" NPT female

KEWDLH-1200	1200	280	40	95.30

Max temperatuur: 150°C



RVS lans - swivel inlaat Kärcher M22x1.5 - uitlaat 1/4" NPT female

KADLH-1200	1100	280	40	89.05

Andere doorlaten op aanvraag: 030, 035, 040, 050, 055, 060, 065, 070

Schuimverbeteraar voor borstels



Inlaat 1/4" BSP male - uitlaat 1/4" NPT female - opening 2,5mm



FT13

280

39.85

Borstellans - met dichte isolatie



Max
temperatuur:
150°C



Zonder borstel - inlaat/uitlaat 1/4" BSP male



LB13-700

700

280

41.30

Autowasborstel



Max
temperatuur:
80°C



Natuurlijk chinees varkenshaar - 1/4" BSP female



CWB-13F
CWB1-13F

1/4"
1/4"

60
90

65.10
90.60

Max
temperatuur:
80°C



Nylon borstelhaar - 1/4" BSP female



RF80-13

1/4"

Nylon

19.10

Turbo nozzle - 045



Max
temperatuur:
60°C



Inlaat 1/4" BSP female



TN160-1345

160

42.95

Andere doorlaten zijn op aanvraag leverbaar: 025, 030, 035, 040.



Max
temperatuur:
100°C



Inlaat 1/4" BSP female - lagedruk chemicaliën nozzle, ook te gebruiken als hogedruk 15° turbo nozzle



TN210-1345

210

189.15

Andere doorlaten zijn op aanvraag leverbaar: 035, 040, 050, 0,55



Max
temperatuur:
100°C



Inlaat 1/4" BSP female



TRN210-1345

210

100.25

Andere doorlaten zijn op aanvraag leverbaar: 020, 025, 030, 035, 040, 050, 055, 060, 065.



Max
temperatuur:
100°C



Inlaat 1/4" BSP female



TN280-1345

280

123.90

Andere doorlaten zijn op aanvraag leverbaar: 030, 035, 040, 050, 0,55, 060, 065, 070.



Max
temperatuur:
100°C



Inlaat 1/4" BSP female



TN350-1345

350

218.20

Andere doorlaten zijn op aanvraag leverbaar: 030, 035, 040, 050, 0,55, 060, 065, 070, 075, 080, 90, 10, 11, 12.

Waterfilter - 300 micron



Aluminium - inlaat 1/2" BSP female - uitlaat 1/2" BSP male



AWF300-21

1/2" fem x 1/2" male

24.15

Inline waterfilter - 177 micron



Kunststof - inlaat en uitlaat 1/2" BSP female



ILWF300-21

1/2" fem x 1/2" fem

19.10

KELM™
pneumatiek

Hydrauliek

Snel-
koppelingen

Afsluiters

Roestvast
staal

Fittingen

Lucht-
conditionering

Gereedschap

Pneumatiek

Diversen

Malleabele
fittingen
& staal

Ringleiding-
systemen

Slangen

Compressoren

Hyperjet-Plus instelbare spuitkop

Max
temperatuur:
150°C



Inlaat 1/4" BSP female - uitlaat 1/4" NPT female - geschikt voor de RVS HPN nozzles, HPN serie 80 - 210 bar



HJ250-1313 250 17.60

Meest gevraagde type!

Hogedruknozzle voor buisreiniging

Max
temperatuur:
150°C



RVS - inlaat 1/4" BSP female



NPC210-6513 3+1 x 0,8mm - 055 12.20

KELM™
pneumatiek

Hydrauliek

Snel-
koppelingen

Afsluiters

Roestvast
staal

Fittingen

Lucht-
conditionering

Gereedschap

Pneumatiek

Diversen

Malleabele
fittingen
& staal

Ringleiding-
systemen

Slangen

Compressoren

Roterende nozzle voor buisreiniging

Max
temperatuur:
130°C



Inlaat 1/4" BSP female



RN-1308 250 3 x 0,8mm - 045 23.55

Lagedruknozzle

Max
temperatuur:
100°C

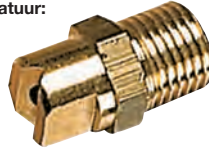

Messing - inlaat 1/4" NPT male



LPN50-13 50 4.05

BP9 instelbare ontlastklep met by-pass

Max
temperatuur:
90°C



Inlaat, uitlaat en by-pass 3/8" BSP female - paneelmontage



ULV200-1 200 30 80.15

210 & 350 bar kleppen zijn op aanvraag leverbaar

CK500 hogedruk terugslagklep

Max
temperatuur:
90°C



Messing - BSP female



CKV310-13	1/4"	310	20	20.80
CKV310-17	3/8"	310	40	20.75
CKV250-21	1/2"	250	60	22.15

SL swivel koppeling

Max
temperatuur:
150°C



Maximale
werkdruk:
280 bar



Rechte rotatiekoppeling



SWL1717 3/8" fem x 3/8" male 40 22.15

Hogedruk knikvrije 5/16" reinigungs slang

Max
temperatuur:
150°C



Maximale
werkdruk:
210 bar



Voor heet water - R1 lengte 5 meter - met knikbeschermers en 3/8" male/female koppelingen



CW85-38FM 3/8" fem x 3/8" male 30 75.35

Max
temperatuur:
150°C



Maximale
werkdruk:
400 bar

Voor heet water - R2 lengte 10 meter - met knikbeschermers en 3/8" male/female koppelingen



HPCW810-38M 3/8" fem x 3/8" male 10 163.30

Spuitpistolen



Europees fabriekaart

Ergonomisch:

De waterpistolen zijn zeer gebruiksvriendelijk, vooral bij professioneel langdurig gebruik. Ze hebben een uitstekende ergonomische vormgeving. Maximale flow door VOLLE doorlaat.

Toepassing:

Algemene industrie, voedingsmiddelenindustrie, schepen & zeer professioneel privé gebruik. Water, chemicaliën, voedingsmiddelen, perslucht, zuren & logen, enz.

Garantie:

5 jaar.

Advies:

Door te reinigen met hoge druk wordt vaak het vuil verplaatst (tegen de wand, het plafond enz.) Bij middendruk & lagedruk is de tijd de positieve factor die het vuil afvoert.

Nito snelkoppelingen: Dit uitgebreide watersnelkoppelingen assortiment in messing en roestvast staal vindt u in hoofdstuk 3.

Nito II heavy duty spuitpistool

Max
temperatuur:
90°C



3/4" BSP female - EPDM dichting

30550A3 3/4" 25 60 208.55

Nito I spuitpistool

Max
temperatuur:
60°C



1/2" insteeknippel - EPDM dichting

53800A1 1/2" 6 11 62.25

3/4" insteeknippel - EPDM dichting

63820A1 3/4" 6 11 62.25

Nito instelbare spuitkop



1/2" en 3/4" slangpilaar aansluiting

20000A4 15 en 20 21.85



3/4" BSP female aansluiting

20300A9 35.25

KELM™
pneumatiek

Hydrauliek

Snel-
koppelingen

Afsluiters

Roestvast
staal

Fittingen

Lucht-
conditionering

Gereedschap

Pneumatiek

Diversen

Malleabele
fittingen
& staal

Ringleiding-
systemen

Slangen

Compressoren

Betaalbare kwaliteit door grootschalige productie en efficiëntie met als resultaat de best mogelijke prijs / kwaliteit verhouding.

Hoofdstuk 8 – Gereedschap

Gerolde metaalborensset

Inhoud set:
1 x 1-10mm
(elke 0,5mm)



19-delig - HSS DIN 334 -
in metalen cassette



1900019



7.40

Geslepen metaalborensset

Inhoud set:
1 x 1-10mm
(elke 0,5mm)



19-delig - HSS DIN 338RN splitpoint -
in metalen cassette



1900029



23.00

Houtspeedborensset

Inhoud set:
6, 8, 10, 12, 13, 14, 16, 17, 18, 19, 20, 22, 25mm



13-delig - zeskant opname -
in een houten kist



14291513



10.05

- KELM™ pneumatiek
- Hydrauliek
- Snel-koppelingen
- Afsluiters
- Roestvast staal
- Fittingen
- Lucht-conditionering
- Gereedschap**
- Pneumatiek
- Diversen
- Malleabele fittingen & staal
- Ringleiding-systemen
- Slangen
- Compressoren

Metaalverzinkborensset

Inhoud set:
6,3mm 8,3mm, 12,4mm,
16,5mm & 20,5mm



6-delig - HSS - zeskant opname -
in metalen cassette



C119-006S



29.90

Universele borensset

Voor gebruik met o.a.kunststof, keramiek, steen,
beton, hout, glas en metaal.

Inhoud set:
4, 5, 6 en 8mm



Met hardmetalen plaat - geschikt
voor gebruik in alle materiaalsoorten -
in kunststof cassette



190004



5.40



Professionals in Flow & Fluid Technology

Tel +31(0) 499 49 10 90
Fax +31(0) 499 49 63 70
Website www.aimfluid.nl
E-mail info@aimfluid.nl

aim fluid control b.v.
Ekkersrijt 7310
NL-5692 HH Son en Breugel
The Netherlands

