



2014

Professionals in
Flow & Fluid Technology





KELM ISO 6432 RVS
rondcilinders



Pagina 470



KELM ISO 15552
cilinders



Pagina 476



KELM
compactcilinders



Pagina 483



KELM hand- en
mechanisch bediende
ventielen



Pagina 488



KELM luchtbediende
ventielen



Pagina 493



KELM elektrisch
bediende ventielen



Pagina 495



KELM logic en
specialist ventielen



Pagina 500



KELM pneumatische
vibratoren



Pagina 501



Flowregelaars

Pagina 502



Aignep
elektropneumatische
ventielen



Pagina 508



Aignep
luchtbediende
ventielen



Pagina 509



Aignep
handbediende
ventielen



Pagina 510



Aignep
magneetventielen



Pagina 513



Aircomp hand-
en mechanisch
bediende ventielen



Pagina 514



Aircomp
luchtbediende
ventielen



Pagina 520



Aircomp
elektropneumatische
schuifventielen



Pagina 521



Vacuümtechniek

Pagina 526



Camozzi cilinders,
ventielen,
persluchtverzorging
en aansluitmateriaal



Pagina 529

KA serie

CA type

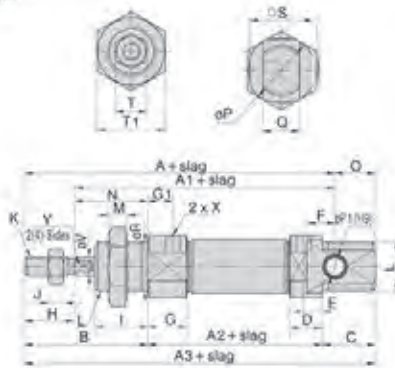

Boring	A	A1	A2	A3	A4	A5	A6	B	C	G1	G2	D	E	F	G	G1	H	I
8	76	86	46	86	74	-	-	28	12	9.5	5	9.5	5	6	11.5	7	12	12
10	76	86	46	86	74	-	-	28	12	9.5	5	9.5	5	6	11.5	7	12	12
12	91	75	50	105	88	-	-	38	17	10.5	6	10.5	6	9	12.5	8	16	17
16	98	82	56	111	94	111	94	38	17	10.5	6	10.5	6	9	12.5	8	16	17
20	115	95	62	129	100	126	106	44	20	14.5	7.5	14.5	7.5	12	14.5	7.5	20	20
25	126	104	65	137	114.5	137	115	40	22	16	8	16	8	10	16	8	22	22
32	-	-	-	-	125	140	126	58	14	16.5	9	-	-	-	16.5	9	20	20
40	-	-	-	-	158	174	158	69	16	22	12	-	-	-	22	12	24	24

Boring	J	K	L	M	N	D	P	P1	D	H	S	F	T1	X	V	W	Y
8	2.5	M6x0.7	M12x1.25	6	16	10	17	4	8	12	15	2	12	M5x0.8	4	-	-
10	2.5	M6x0.7	M12x1.25	6	16	10	17	4	8	12	15	2	12	M5x0.8	4	-	-
12	5	M6x1.0	M16x1.5	6	22	14	20	6	12	16	18	10	22	M5x0.8	6	-	5
16	5	M6x1.0	M16x1.5	6	22	13	22	6	12	16	20	10	22	M5x0.8	6	13.5	5
20	6	M8x1.25	M22x1.5	7	24	11	29	8	18	22	25	12	29	1/8"	8	16.5	6
25	6	M10x1.25	M22x1.5	7	28	11	32.5	8	16	22	30	17	29	1/8"	10	16.5	8
32	6	M10x1.25	M30x1.5	7	38	-	37.5	-	-	30	34.5	17	36	1/8"	12	16.5	10
40	7	M12x1.25	M38x1.5	8	45	-	46.5	-	-	38	42.5	17	46	1/8"	16	12.5	14

KB serie

ø16-ø25

Boring	A	A1	A2	A3	A4	A5	B	C	D
16	98	82	56	111	94	111	98	17	12.1
20	115	95	62	129	106	126	114	20	14.5
25	126	104	65	137	113.5	137	114	23	16

Boring	H	J	K	L	M	O	N	
16	16	17	5	M6x1.0	M16x1.5	6	13	22
20	20	20	6	M8x1.25	M22x1.5	7	11	29
25	22	22	6	M10x1.25	M22x1.5	7	11	29

ø32-ø40

Boring	A2	A4	A5	B	C	D	D1	D2	D3	D4
32	68	124	140	58	14	16.5	9	11.5	14.5	7.5
40	69	157.5	174	69	16	22	12	12	21.5	11.5

Boring	D5	G	G1	G2	H	I	J	K
32	11	56.5	9	14.8	20	30	8	M10x1.25
40	14	22	12	12	24	26	7	M12x1.25

Boring	L	M	N	P	S	T	T1	V	W	X
32	M30x1.5	7	36	37.5	34.5	17	36	12	10.5	1/8"
40	M30x1.5	8	45	46.5	42.5	17	46	16	12.5	1/8"

KC serie

CA type

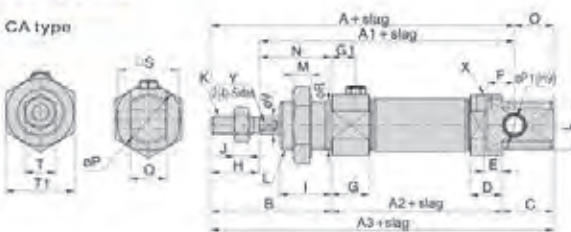

Binnenstructuur



Nr.	Omschrijving	Aanpak
1	130kg	SP4
2	Zuigertrommel	Aluminium
3	Plaatring las uitvoering	SP4
4	Alu verbindings	Aluminium
5	Omsluiting	Aluminium
6	Kay voorzet	Aluminiumlegering
7	Ring	SP4
8	Sluis	SP4
9	Zuiger	SP4 Aluminiumlegering
10	130kg slag	SP4
11	130kg	Alu verbindings
12	Sluis	Aluminium
13	Alu verbindings	Aluminiumlegering

CM type

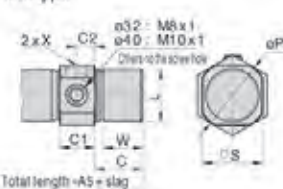

Boring	A			A1		
	0-50	51-100	101-150	0-50	51-100	101-150
8	101	-	-	89	-	-
10	101	-	-	89	-	-
12	116	-	-	100	-	-
16	123	148	-	107	132	-
20	140	165	190	120	145	176
25	151	178	201	129	154	179
32	-	-	-	-	-	-
40	-	-	-	-	-	-

Boring	A2			A5		
	0-50	51-100	101-150	0-50	51-100	101-150
8	89	-	-	-	-	-
10	99	-	-	-	-	-
12	113	-	-	-	-	-
16	119	144	-	136	161	-
20	131	156	181	151	176	205
25	139.5	164.5	189.5	162	187	212
32	150	175	200	165	190	215
40	183	208	233	199	224	249

Boring	A2			A5		
	0-50	51-100	101-150	0-50	51-100	101-150
8	71	-	-	111	-	-
10	71	-	-	111	-	-
12	75	-	-	130	-	-
16	81	108	-	136	161	-
20	87	112	137	151	176	201
25	90	115	140	162	187	212
32	-	-	-	-	-	-
40	-	-	-	-	-	-

Boring	A2			C	C1	C2	
	0-50	51-100	101-150				
8	-	-	-	26	12	9.5	5
10	-	-	-	26	12	9.5	5
12	-	-	-	38	17	10.5	6
16	119	144	-	38	17	10.5	6
20	131	156	181	44	20	14.5	7.5
25	140	166	190	50	22	16	8
32	151	176	201	56	24	16.5	9
40	183	208	233	69	26	22	12

KELM™
pneumatiek

Hydrauliek

Snel-
koppelingen

Afsluiters

Roestvast
staal

Fittingen

Lucht-
conditionering

Gereedschap

Pneumatiek

Diversen

Malleabele
fittingen
& staal

Ringleiding-
systemen

Slangen

Compressoren

PERSLUCHTCILINDERS



ISO 6432 RVS rondcilinders

Werktemperatuur:
-20°C tot +70°C

Werkdruk:
2 tot 10 bar

Medium:
Geconditioneerde perslucht, gefilterd (40µm) en gesmeerd.
Met kunststof buffers
Volledige technische specificaties worden op aanvraag verstrekt

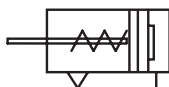

Tech Data
3000

Magnetisch - enkelwerkend

0334	mm	mm			Rod Thread	€
KC-8X10-S-CA	8	10	M5	M12 x 1,25	M4 x 0,7	27.95
KC-8X15-S-CA	8	15	M5	M12 x 1,25	M4 x 0,7	27.95
KC-8X20-S-CA	8	20	M5	M12 x 1,25	M4 x 0,7	27.95
KC-8X25-S-CA	8	25	M5	M12 x 1,25	M4 x 0,7	27.95
KC-8X30-S-CA	8	30	M5	M12 x 1,25	M4 x 0,7	29.00
KC-8X40-S-CA	8	40	M5	M12 x 1,25	M4 x 0,7	29.00
KC-8X50-S-CA	8	50	M5	M12 x 1,25	M4 x 0,7	29.00
KC-10X10-S-CA	10	10	M5	M12 x 1,25	M4 x 0,7	29.00
KC-10X15-S-CA	10	15	M5	M12 x 1,25	M4 x 0,7	29.00
KC-10X20-S-CA	10	20	M5	M12 x 1,25	M4 x 0,7	29.00
KC-10X25-S-CA	10	25	M5	M12 x 1,25	M4 x 0,7	29.00
KC-10X30-S-CA	10	30	M5	M12 x 1,25	M4 x 0,7	30.65
KC-10X40-S-CA	10	40	M5	M12 x 1,25	M4 x 0,7	30.65
KC-10X50-S-CA	10	50	M5	M12 x 1,25	M4 x 0,7	30.65
KC-12X10-S-CA	12	10	M5	M16 x 1,5	M6 x 1,0	33.90
KC-12X15-S-CA	12	15	M5	M16 x 1,5	M6 x 1,0	33.90
KC-12X20-S-CA	12	20	M5	M16 x 1,5	M6 x 1,0	33.90
KC-12X25-S-CA	12	25	M5	M16 x 1,5	M6 x 1,0	33.90
KC-12X30-S-CA	12	30	M5	M16 x 1,5	M6 x 1,0	35.60
KC-12X40-S-CA	12	40	M5	M16 x 1,5	M6 x 1,0	35.60
KC-12X50-S-CA	12	50	M5	M16 x 1,5	M6 x 1,0	35.60
KC-16X10-S-CA	16	10	M5	M16 x 1,5	M6 x 1,0	40.00
KC-16X15-S-CA	16	15	M5	M16 x 1,5	M6 x 1,0	41.70
KC-16X20-S-CA	16	20	M5	M16 x 1,5	M6 x 1,0	41.70
KC-16X25-S-CA	16	25	M5	M16 x 1,5	M6 x 1,0	41.70
KC-16X30-S-CA	16	30	M5	M16 x 1,5	M6 x 1,0	43.15
KC-16X40-S-CA	16	40	M5	M16 x 1,5	M6 x 1,0	44.55
KC-16X50-S-CA	16	50	M5	M16 x 1,5	M6 x 1,0	44.55
KC-16X60-S-CA	16	60	M5	M16 x 1,5	M6 x 1,0	45.95
KC-16X75-S-CA	16	75	M5	M16 x 1,5	M6 x 1,0	45.95
KC-16X80-S-CA	16	80	M5	M16 x 1,5	M6 x 1,0	48.80
KC-16X100-S-CA	16	100	M5	M16 x 1,5	M6 x 1,0	48.80
KC-20X10-S-CA	20	10	1/8"	M22 x 1,5	M8 x 1,25	45.90
KC-20X15-S-CA	20	15	1/8"	M22 x 1,5	M8 x 1,25	45.90
KC-20X20-S-CA	20	20	1/8"	M22 x 1,5	M8 x 1,25	48.05
KC-20X25-S-CA	20	25	1/8"	M22 x 1,5	M8 x 1,25	48.05
KC-20X30-S-CA	20	30	1/8"	M22 x 1,5	M8 x 1,25	48.65
KC-20X40-S-CA	20	40	1/8"	M22 x 1,5	M8 x 1,25	48.65
KC-20X50-S-CA	20	50	1/8"	M22 x 1,5	M8 x 1,25	48.65
KC-20X60-S-CA	20	60	1/8"	M22 x 1,5	M8 x 1,25	51.65
KC-20X75-S-CA	20	75	1/8"	M22 x 1,5	M8 x 1,25	51.65
KC-20X80-S-CA	20	80	1/8"	M22 x 1,5	M8 x 1,25	56.20

0334	mm	mm			Rod Thread	€
KC-20X100-S-CA	20	100	1/8"	M22 x 1,5	M8 x 1,25	56.20
KC-20X125-S-CA	20	125	1/8"	M22 x 1,5	M8 x 1,25	57.40
KC-20X150-S-CA	20	150	1/8"	M22 x 1,5	M8 x 1,25	60.15
KC-25X10-S-CA	25	10	1/8"	M22 x 1,5	M10 x 1,25	52.00
KC-25X15-S-CA	25	15	1/8"	M22 x 1,5	M10 x 1,25	52.00
KC-25X20-S-CA	25	20	1/8"	M22 x 1,5	M10 x 1,25	52.00
KC-25X25-S-CA	25	25	1/8"	M22 x 1,5	M10 x 1,25	52.00
KC-25X30-S-CA	25	30	1/8"	M22 x 1,5	M10 x 1,25	55.95
KC-25X40-S-CA	25	40	1/8"	M22 x 1,5	M10 x 1,25	55.95
KC-25X50-S-CA	25	50	1/8"	M22 x 1,5	M10 x 1,25	55.95
KC-25X60-S-CA	25	60	1/8"	M22 x 1,5	M10 x 1,25	58.75
KC-25X75-S-CA	25	75	1/8"	M22 x 1,5	M10 x 1,25	58.75
KC-25X80-S-CA	25	80	1/8"	M22 x 1,5	M10 x 1,25	63.75
KC-25X100-S-CA	25	100	1/8"	M22 x 1,5	M10 x 1,25	63.75
KC-25X125-S-CA	25	125	1/8"	M22 x 1,5	M10 x 1,25	64.05
KC-25X150-S-CA	25	150	1/8"	M22 x 1,5	M10 x 1,25	67.15
KC-32X10-S-CM	32	10	1/8"	M30 x 1,5	M10 x 1,25	70.65
KC-32X15-S-CM	32	15	1/8"	M30 x 1,5	M10 x 1,25	70.65
KC-32X20-S-CM	32	20	1/8"	M30 x 1,5	M10 x 1,25	70.65
KC-32X25-S-CM	32	25	1/8"	M30 x 1,5	M10 x 1,25	70.65
KC-32X30-S-CM	32	30	1/8"	M30 x 1,5	M10 x 1,25	75.55
KC-32X40-S-CM	32	40	1/8"	M30 x 1,5	M10 x 1,25	75.55
KC-32X50-S-CM	32	50	1/8"	M30 x 1,5	M10 x 1,25	75.55
KC-32X60-S-CM	32	60	1/8"	M30 x 1,5	M10 x 1,25	80.65
KC-32X75-S-CM	32	75	1/8"	M30 x 1,5	M10 x 1,25	80.65
KC-32X80-S-CM	32	80	1/8"	M30 x 1,5	M10 x 1,25	85.50
KC-32X100-S-CM	32	100	1/8"	M30 x 1,5	M10 x 1,25	85.50
KC-32X125-S-CM	32	125	1/8"	M30 x 1,5	M10 x 1,25	90.40
KC-32X150-S-CM	32	150	1/8"	M30 x 1,5	M10 x 1,25	95.15
KC-40X10-S-CM	40	10	1/4"	M38 x 1,5	M12 x 1,25	85.80
KC-40X15-S-CM	40	15	1/4"	M38 x 1,5	M12 x 1,25	85.80
KC-40X20-S-CM	40	20	1/4"	M38 x 1,5	M12 x 1,25	85.80
KC-40X25-S-CM	40	25	1/4"	M38 x 1,5	M12 x 1,25	85.80
KC-40X30-S-CM	40	30	1/4"	M38 x 1,5	M12 x 1,25	91.95
KC-40X40-S-CM	40	40	1/4"	M38 x 1,5	M12 x 1,25	91.95
KC-40X50-S-CM	40	50	1/4"	M38 x 1,5	M12 x 1,25	91.95
KC-40X60-S-CM	40	60	1/4"	M38 x 1,5	M12 x 1,25	98.55
KC-40X75-S-CM	40	75	1/4"	M38 x 1,5	M12 x 1,25	98.55
KC-40X80-S-CM	40	80	1/4"	M38 x 1,5	M12 x 1,25	104.85
KC-40X100-S-CM	40	100	1/4"	M38 x 1,5	M12 x 1,25	104.85
KC-40X125-S-CM	40	125	1/4"	M38 x 1,5	M12 x 1,25	111.10
KC-40X150-S-CM	40	150	1/4"	M38 x 1,5	M12 x 1,25	117.60

ISO 6432 RVS rondcilinders

Werktemperatuur:
-20°C tot +70°C

Werkdruk:
1 tot 10 bar

Medium:

Geconditioneerde perslucht, gefilterd (40µm) en gesmeerd.

Type KA: met kunststof buffers

Type KB: met instelbare buffering

Volledige technische specificaties worden op aanvraag verstrekt

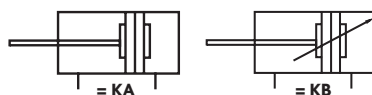

Tech Data
3001

Magnetisch - dubbelwerkend

Raadpleeg de volgende pagina voor andere maten in deze reeks

0334	mm	mm		A	Rod Thread	€
KA-8X10-S-CA	8	10	M5	M12 x 1,25	M4 x 0,7	23.70
KA-8X15-S-CA	8	15	M5	M12 x 1,25	M4 x 0,7	23.70
KA-8X20-S-CA	8	20	M5	M12 x 1,25	M4 x 0,7	23.70
KA-8X25-S-CA	8	25	M5	M12 x 1,25	M4 x 0,7	23.70
KA-8X30-S-CA	8	30	M5	M12 x 1,25	M4 x 0,7	24.70
KA-8X40-S-CA	8	40	M5	M12 x 1,25	M4 x 0,7	24.70
KA-8X50-S-CA	8	50	M5	M12 x 1,25	M4 x 0,7	24.70
KA-8X60-S-CA	8	60	M5	M12 x 1,25	M4 x 0,7	25.65
KA-8X75-S-CA	8	75	M5	M12 x 1,25	M4 x 0,7	25.65
KA-8X80-S-CA	8	80	M5	M12 x 1,25	M4 x 0,7	26.75
KA-8X100-S-CA	8	100	M5	M12 x 1,25	M4 x 0,7	26.75
KA-8X125-S-CA	8	125	M5	M12 x 1,25	M4 x 0,7	28.05
KA-8X150-S-CA	8	150	M5	M12 x 1,25	M4 x 0,7	29.20
KA-10X10-S-CA	10	10	M5	M12 x 1,25	M4 x 0,7	24.70
KA-10X15-S-CA	10	15	M5	M12 x 1,25	M4 x 0,7	24.70
KA-10X20-S-CA	10	20	M5	M12 x 1,25	M4 x 0,7	24.70
KA-10X25-S-CA	10	25	M5	M12 x 1,25	M4 x 0,7	24.70
KA-10X30-S-CA	10	30	M5	M12 x 1,25	M4 x 0,7	25.80
KA-10X40-S-CA	10	40	M5	M12 x 1,25	M4 x 0,7	25.80
KA-10X50-S-CA	10	50	M5	M12 x 1,25	M4 x 0,7	25.80
KA-10X60-S-CA	10	60	M5	M12 x 1,25	M4 x 0,7	27.55
KA-10X75-S-CA	10	75	M5	M12 x 1,25	M4 x 0,7	27.55
KA-10X80-S-CA	10	80	M5	M12 x 1,25	M4 x 0,7	28.80
KA-10X100-S-CA	10	100	M5	M12 x 1,25	M4 x 0,7	28.80
KA-10X125-S-CA	10	125	M5	M12 x 1,25	M4 x 0,7	30.70
KA-10X150-S-CA	10	150	M5	M12 x 1,25	M4 x 0,7	32.35
KA-10X160-S-CA	10	160	M5	M12 x 1,25	M4 x 0,7	33.75
KA-10X175-S-CA	10	175	M5	M12 x 1,25	M4 x 0,7	33.75
KA-10X200-S-CA	10	200	M5	M12 x 1,25	M4 x 0,7	35.45
KA-12X10-S-CA	12	10	M5	M16 x 1,5	M6 x 1,0	29.05
KA-12X15-S-CA	12	15	M5	M16 x 1,5	M6 x 1,0	29.05
KA-12X20-S-CA	12	20	M5	M16 x 1,5	M6 x 1,0	29.05
KA-12X25-S-CA	12	25	M5	M16 x 1,5	M6 x 1,0	29.70
KA-12X30-S-CA	12	30	M5	M16 x 1,5	M6 x 1,0	30.45
KA-12X40-S-CA	12	40	M5	M16 x 1,5	M6 x 1,0	30.45
KA-12X50-S-CA	12	50	M5	M16 x 1,5	M6 x 1,0	30.45
KA-12X60-S-CA	12	60	M5	M16 x 1,5	M6 x 1,0	32.35
KA-12X75-S-CA	12	75	M5	M16 x 1,5	M6 x 1,0	32.35
KA-12X80-S-CA	12	80	M5	M16 x 1,5	M6 x 1,0	33.75
KA-12X100-S-CA	12	100	M5	M16 x 1,5	M6 x 1,0	33.75
KA-12X125-S-CA	12	125	M5	M16 x 1,5	M6 x 1,0	35.05
KA-12X150-S-CA	12	150	M5	M16 x 1,5	M6 x 1,0	37.35
KA-12X160-S-CA	12	160	M5	M16 x 1,5	M6 x 1,0	40.25
KA-12X175-S-CA	12	175	M5	M16 x 1,5	M6 x 1,0	40.25
KA-12X200-S-CA	12	200	M5	M16 x 1,5	M6 x 1,0	40.80
KA-12X250-S-CA	12	250	M5	M16 x 1,5	M6 x 1,0	44.65
KB-16X10-S-CA	16	10	M5	M16 x 1,5	M6 x 1,0	46.75
KB-16X15-S-CA	16	15	M5	M16 x 1,5	M6 x 1,0	46.75
KB-16X20-S-CA	16	20	M5	M16 x 1,5	M6 x 1,0	46.75
KB-16X25-S-CA	16	25	M5	M16 x 1,5	M6 x 1,0	46.75

0334	mm	mm		A	Rod Thread	€
KB-16X30-S-CA	16	30	M5	M16 x 1,5	M6 x 1,0	48.90
KB-16X40-S-CA	16	40	M5	M16 x 1,5	M6 x 1,0	48.90
KB-16X50-S-CA	16	50	M5	M16 x 1,5	M6 x 1,0	50.85
KB-16X60-S-CA	16	60	M5	M16 x 1,5	M6 x 1,0	50.85
KB-16X75-S-CA	16	75	M5	M16 x 1,5	M6 x 1,0	50.85
KB-16X80-S-CA	16	80	M5	M16 x 1,5	M6 x 1,0	54.00
KB-16X100-S-CA	16	100	M5	M16 x 1,5	M6 x 1,0	54.00
KB-16X125-S-CA	16	125	M5	M16 x 1,5	M6 x 1,0	53.75
KB-16X150-S-CA	16	150	M5	M16 x 1,5	M6 x 1,0	58.20
KB-16X160-S-CA	16	160	M5	M16 x 1,5	M6 x 1,0	59.50
KB-16X175-S-CA	16	175	M5	M16 x 1,5	M6 x 1,0	59.50
KB-16X200-S-CA	16	200	M5	M16 x 1,5	M6 x 1,0	59.85
KB-16X250-S-CA	16	250	M5	M16 x 1,5	M6 x 1,0	64.75
KB-16X300-S-CA	16	300	M5	M16 x 1,5	M6 x 1,0	69.05
KB-20X10-S-CA	20	10	1/8"	M22 x 1,5	M8 x 1,25	52.25
KB-20X15-S-CA	20	15	1/8"	M22 x 1,5	M8 x 1,25	52.25
KB-20X20-S-CA	20	20	1/8"	M22 x 1,5	M8 x 1,25	52.25
KB-20X25-S-CA	20	25	1/8"	M22 x 1,5	M8 x 1,25	53.55
KB-20X30-S-CA	20	30	1/8"	M22 x 1,5	M8 x 1,25	56.00
KB-20X40-S-CA	20	40	1/8"	M22 x 1,5	M8 x 1,25	56.00
KB-20X50-S-CA	20	50	1/8"	M22 x 1,5	M8 x 1,25	56.00
KB-20X60-S-CA	20	60	1/8"	M22 x 1,5	M8 x 1,25	59.00
KB-20X75-S-CA	20	75	1/8"	M22 x 1,5	M8 x 1,25	59.00
KB-20X80-S-CA	20	80	1/8"	M22 x 1,5	M8 x 1,25	59.00
KB-20X100-S-CA	20	100	1/8"	M22 x 1,5	M8 x 1,25	61.20
KB-20X125-S-CA	20	125	1/8"	M22 x 1,5	M8 x 1,25	64.75
KB-20X150-S-CA	20	150	1/8"	M22 x 1,5	M8 x 1,25	64.75
KB-20X160-S-CA	20	160	1/8"	M22 x 1,5	M8 x 1,25	67.30
KB-20X175-S-CA	20	175	1/8"	M22 x 1,5	M8 x 1,25	67.30
KB-20X200-S-CA	20	200	1/8"	M22 x 1,5	M8 x 1,25	68.80
KB-20X250-S-CA	20	250	1/8"	M22 x 1,5	M8 x 1,25	75.00
KB-20X300-S-CA	20	300	1/8"	M22 x 1,5	M8 x 1,25	80.35
KB-20X350-S-CA	20	350	1/8"	M22 x 1,5	M8 x 1,25	87.30
KB-20X400-S-CA	20	400	1/8"	M22 x 1,5	M8 x 1,25	93.55
KB-20X450-S-CA	20	450	1/8"	M22 x 1,5	M8 x 1,25	99.50
KB-20X500-S-CA	20	500	1/8"	M22 x 1,5	M8 x 1,25	105.55
KB-25X10-S-CA	25	10	1/8"	M22 x 1,5	M10 x 1,25	58.25
KB-25X15-S-CA	25	15	1/8"	M22 x 1,5	M10 x 1,25	58.25
KB-25X20-S-CA	25	20	1/8"	M22 x 1,5	M10 x 1,25	58.25
KB-25X25-S-CA	25	25	1/8"	M22 x 1,5	M10 x 1,25	58.25
KB-25X30-S-CA	25	30	1/8"	M22 x 1,5	M10 x 1,25	62.60
KB-25X40-S-CA	25	40	1/8"	M22 x 1,5	M10 x 1,25	62.60
KB-25X50-S-CA	25	50	1/8"	M22 x 1,5	M10 x 1,25	63.75
KB-25X60-S-CA	25	60	1/8"	M22 x 1,5	M10 x 1,25	63.75
KB-25X75-S-CA	25	75	1/8"	M22 x 1,5	M10 x 1,25	66.60
KB-25X80-S-CA	25	80	1/8"	M22 x 1,5	M10 x 1,25	66.60
KB-25X100-S-CA	25	100	1/8"	M22 x 1,5	M10 x 1,25	66.80

KELM™
pneumatiek

Hydrauliek

Snel-
koppelingen

Afsluiters

Roestvast
staal

Fittingen

Lucht-
conditionering

Gereedschap

Pneumatiek

Diversen

Malleabele
fittings
& staal

Ringleiding-
systemen

Slangen

Compressoren

ISO 6432 RVS rondcilinders

Werktemperatuur:
-20°C tot +70°C

Werkdruk:
1 tot 10 bar

Medium:

Geconditioneerde perslucht, gefilterd (40µm) en gesmeerd.

Type KA: met kunststof buffers

Type KB: met instelbare buffering

Volledige technische specificaties worden op aanvraag verstrekt

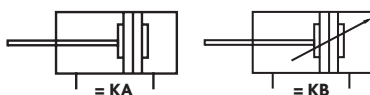

Tech Data
3001

Magnetisch - dubbelwerkend

0334	mm	mm	mm	A	Rod Thread	€
KB-25X125-S-CA	25	125	1/8"	M22 x 1,5	M10 x 1,25	71.15
KB-25X150-S-CA	25	150	1/8"	M22 x 1,5	M10 x 1,25	73.30
KB-25X160-S-CA	25	160	1/8"	M22 x 1,5	M10 x 1,25	77.30
KB-25X175-S-CA	25	175	1/8"	M22 x 1,5	M10 x 1,25	75.25
KB-25X200-S-CA	25	200	1/8"	M22 x 1,5	M10 x 1,25	80.25
KB-25X250-S-CA	25	250	1/8"	M22 x 1,5	M10 x 1,25	89.65
KB-25X300-S-CA	25	300	1/8"	M22 x 1,5	M10 x 1,25	89.35
KB-25X350-S-CA	25	350	1/8"	M22 x 1,5	M10 x 1,25	96.25
KB-25X400-S-CA	25	400	1/8"	M22 x 1,5	M10 x 1,25	100.00
KB-25X450-S-CA	25	450	1/8"	M22 x 1,5	M10 x 1,25	107.15
KB-25X500-S-CA	25	500	1/8"	M22 x 1,5	M10 x 1,25	117.00
KB-25X600-S-CA	25	600	1/8"	M22 x 1,5	M10 x 1,25	128.70
KB-32X10-S-CM	32	10	1/8"	M30 x 1,5	M10 x 1,25	77.35
KB-32X15-S-CM	32	15	1/8"	M30 x 1,5	M10 x 1,25	77.35
KB-32X20-S-CM	32	20	1/8"	M30 x 1,5	M10 x 1,25	77.35
KB-32X25-S-CM	32	25	1/8"	M30 x 1,5	M10 x 1,25	77.35
KB-32X30-S-CM	32	30	1/8"	M30 x 1,5	M10 x 1,25	81.50
KB-32X40-S-CM	32	40	1/8"	M30 x 1,5	M10 x 1,25	81.50
KB-32X50-S-CM	32	50	1/8"	M30 x 1,5	M10 x 1,25	81.50
KB-32X60-S-CM	32	60	1/8"	M30 x 1,5	M10 x 1,25	85.70
KB-32X75-S-CM	32	75	1/8"	M30 x 1,5	M10 x 1,25	85.70
KB-32X80-S-CM	32	80	1/8"	M30 x 1,5	M10 x 1,25	90.10
KB-32X100-S-CM	32	100	1/8"	M30 x 1,5	M10 x 1,25	90.10
KB-32X125-S-CM	32	125	1/8"	M30 x 1,5	M10 x 1,25	94.30
KB-32X150-S-CM	32	150	1/8"	M30 x 1,5	M10 x 1,25	98.55
KB-32X160-S-CM	32	160	1/8"	M30 x 1,5	M10 x 1,25	102.80
KB-32X175-S-CM	32	175	1/8"	M30 x 1,5	M10 x 1,25	102.80
KB-32X200-S-CM	32	200	1/8"	M30 x 1,5	M10 x 1,25	106.90
KB-32X250-S-CM	32	250	1/8"	M30 x 1,5	M10 x 1,25	115.25

0334	mm	mm	mm	A	Rod Thread	€
KB-32X300-S-CM	32	300	1/8"	M30 x 1,5	M10 x 1,25	124.30
KB-32X350-S-CM	32	350	1/8"	M30 x 1,5	M10 x 1,25	132.90
KB-32X400-S-CM	32	400	1/8"	M30 x 1,5	M10 x 1,25	142.05
KB-32X450-S-CM	32	450	1/8"	M30 x 1,5	M10 x 1,25	151.20
KB-32X500-S-CM	32	500	1/8"	M30 x 1,5	M10 x 1,25	160.25
KB-32X600-S-CM	32	600	1/8"	M30 x 1,5	M10 x 1,25	178.05
KB-40X10-S-CM	40	10	1/4"	M38 x 1,5	M12 x 1,25	91.80
KB-40X15-S-CM	40	15	1/4"	M38 x 1,5	M12 x 1,25	91.80
KB-40X20-S-CM	40	20	1/4"	M38 x 1,5	M12 x 1,25	91.80
KB-40X25-S-CM	40	25	1/4"	M38 x 1,5	M12 x 1,25	91.80
KB-40X30-S-CM	40	30	1/4"	M38 x 1,5	M12 x 1,25	97.50
KB-40X40-S-CM	40	40	1/4"	M38 x 1,5	M12 x 1,25	97.50
KB-40X50-S-CM	40	50	1/4"	M38 x 1,5	M12 x 1,25	97.50
KB-40X60-S-CM	40	60	1/4"	M38 x 1,5	M12 x 1,25	103.00
KB-40X75-S-CM	40	75	1/4"	M38 x 1,5	M12 x 1,25	103.00
KB-40X80-S-CM	40	80	1/4"	M38 x 1,5	M12 x 1,25	108.65
KB-40X100-S-CM	40	100	1/4"	M38 x 1,5	M12 x 1,25	108.65
KB-40X125-S-CM	40	125	1/4"	M38 x 1,5	M12 x 1,25	114.10
KB-40X150-S-CM	40	150	1/4"	M38 x 1,5	M12 x 1,25	118.85
KB-40X160-S-CM	40	160	1/4"	M38 x 1,5	M12 x 1,25	125.15
KB-40X175-S-CM	40	175	1/4"	M38 x 1,5	M12 x 1,25	125.15
KB-40X200-S-CM	40	200	1/4"	M38 x 1,5	M12 x 1,25	130.65
KB-40X250-S-CM	40	250	1/4"	M38 x 1,5	M12 x 1,25	147.45
KB-40X300-S-CM	40	300	1/4"	M38 x 1,5	M12 x 1,25	158.75
KB-40X350-S-CM	40	350	1/4"	M38 x 1,5	M12 x 1,25	170.35
KB-40X400-S-CM	40	400	1/4"	M38 x 1,5	M12 x 1,25	181.95
KB-40X450-S-CM	40	450	1/4"	M38 x 1,5	M12 x 1,25	193.60
KB-40X500-S-CM	40	500	1/4"	M38 x 1,5	M12 x 1,25	205.70
KB-40X600-S-CM	40	600	1/4"	M38 x 1,5	M12 x 1,25	229.40

ISO 6432 bevestigingen

Tech Data
3002



Flensbevestiging voor 'FA'

0334	mm	€
F-KA8FA	8/10	1.55
F-KA12FA	12/16	1.70
F-KA20FA	20/25	2.45

Tech Data
3003



Zwenktapbevestiging voor 'TC'

0334	mm	€
F-KA8TC	8/10	4.55
F-KA12TC	12/16	5.65
F-KA20TC	20/25	6.35
F-KA32TC	32	8.25
F-KA40TC	40	12.65

ISO 6432 bevestigingen

Tech Data
3004



Scharnierbevestiging achter 'SDB'

0334	Ø mm	€
F-KA8SDB	8/10	3.50
F-KA12SDB	12/16	5.20
F-KA20SDB	20/25	5.65
F-KA32SDB	32	6.40
F-KA40SDB	40	7.05

Tech Data
3005



Bevestigingsvoet 'LB' (paar)

0334	Ø mm	€
F-KA8LB	8/10	3.55
F-KA12LB	12/16	5.15
F-KA20LB	20/25	6.40
F-KA32LB	32	7.55
F-KA40LB	40	9.55

Tech Data
3006



Zuigerstang gaffel 'Y'

0334	Ø mm	€	
F-M04070YE	8/10	M4 x 0,7	4.55
F-M06100YE	12/16	M6 x 1	6.40
F-M08125YE	20	M8 x 1,25	6.65
F-M1025YE	25/32	M10 x 1,25	8.45

Tech Data
3007



Zuigerstang gaffel 'I'

0334	Ø mm	€	
F-M06100II	12/16	M6 x 1	4.55
F-M08125II	20	M8 x 1,25	5.00
F-M10125II	25/32	M10 x 1,25	6.20
F-M12125II	40	M12 x 1,25	8.20

Tech Data
3008



Uitlijncop 'F'

0334	Ø mm	€	
F-M08125F	20	M8 x 1,25	16.30
F-M10125F	25/32	M10 x 1,25	18.40
F-M12125F	40	M12 x 1,25	19.90

Tech Data
3009



Universele kogelstangkop 'U'

0334	Ø mm	€	
F-M04070U	8/10	M4 x 0,7	7.60
F-M06100U	12/16	M6 x 1	7.80
F-M08125U	20	M8 x 1,25	7.90
F-M10125U	25/32	M10 x 1,25	9.65
F-M12125U	40	M12 x 1,25	11.35

ISO 6432 magneetschakelaars

Tech Data
3010



Tweepolig - NO met LED

0334	Ø mm	€	
CS1-M-8	8	5-240V AC/DC	20.65
CS1-M-10	10	5-240V AC/DC	20.65
CS1-M-12	12	5-240V AC/DC	20.65
CS1-M-16	16	5-240V AC/DC	20.65
CS1-M-20	20	5-240V AC/DC	20.65
CS1-M-25	25	5-240V AC/DC	20.65
CS1-M-32	32	5-240V AC/DC	20.65
CS1-M-40	40	5-240V AC/DC	20.65

KELM™
pneumatiek

Hydrauliek

Snel-
koppelingen

Afsluiters

Roestvast
staal

Fittingen

Lucht-
conditionering

Gereedschap

Pneumatiek

Diversen

Malleabele
fittingen
& staal

Ringleiding-
systemen

Slangen

Compressoren

ISO 15552 PERSLUCHTCILINDER



ACCESSOIRES & BEVESTIGING SELECTIE

Voor regelkoppelingen
zie pagina 504

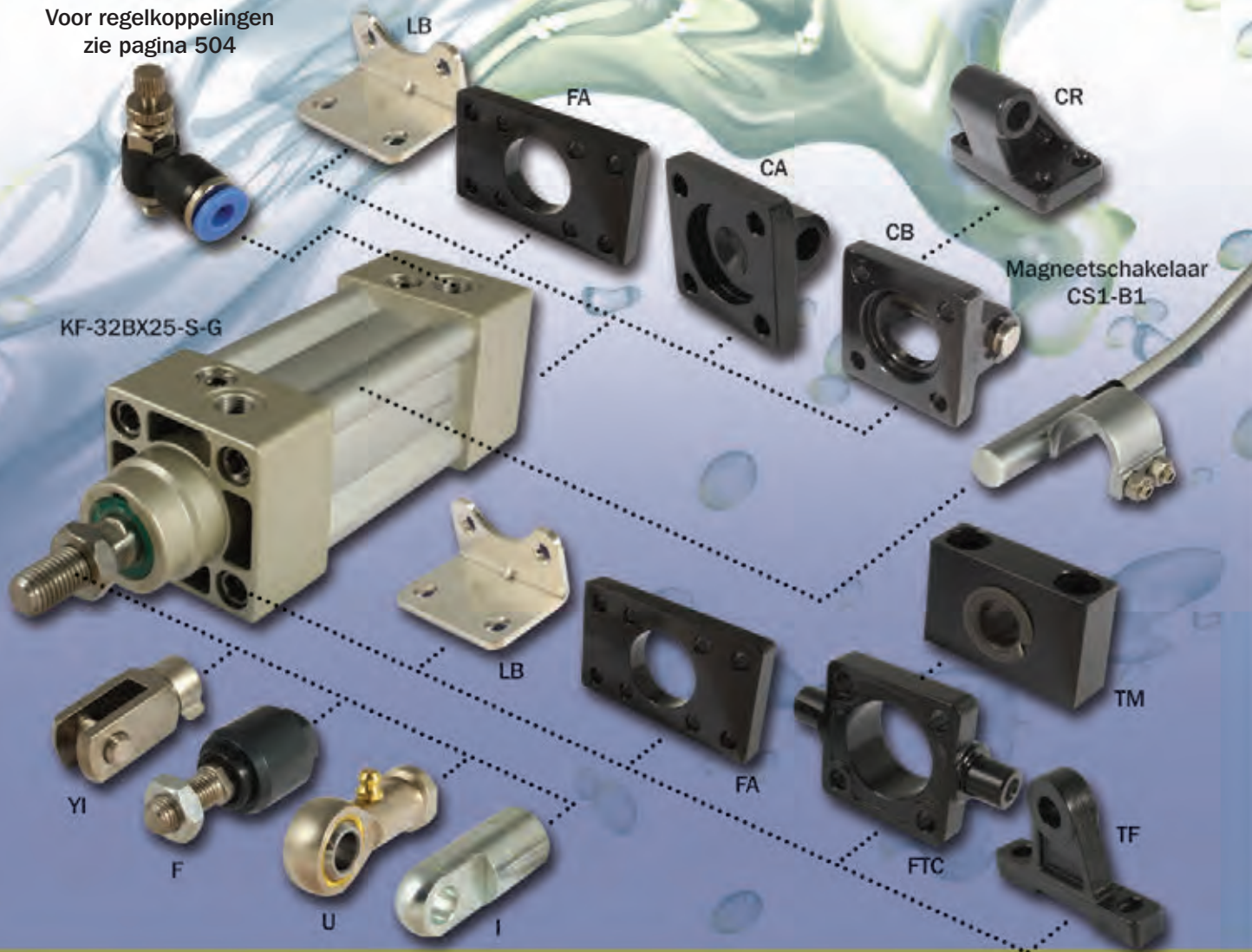

ISO15552 Cilinders

FA - Flensbevestiging voor/achter

FTC - Zwenktapbevestiging voor

TF - Zwenktap/gaffelbevestiging voor

TM - Zwenktapsteun

CA - Enkel achterscharnier

CB - Dubbel achterscharnier

CR - Bevestigingssteun achter

LB - Bevestigingsvoet (paar)

YI - Zuigerstang gaffel

I - Zuigerstang gaffel

F - Uitlijnkop

U - Universele kogelstangkop

Tweepolige magneetschakelaars
N/O met LED

Driepolige magneetschakelaars
N/O met NPN of PNP stroming

Cilinders op pagina 476

Bevestigingen op pagina 478

Magneetschakelaars op pagina 480

KF serie

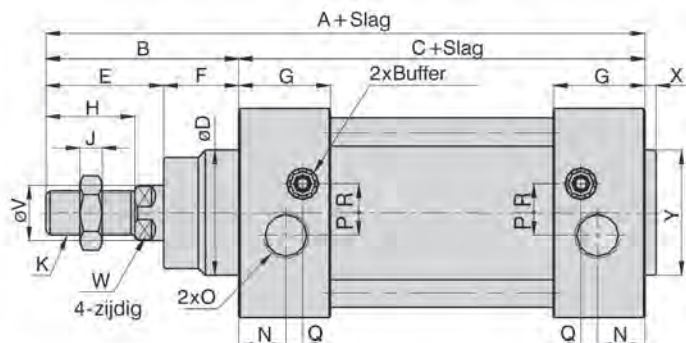
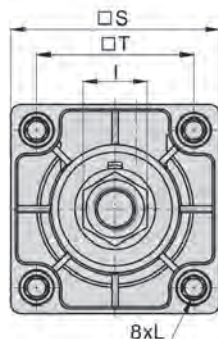

Boring	A	B	G	D	E	F	G	H	I	J	K	L	N	O	P	Q	R	S	T	V	W	X	Y
32	142	48	94	30	29	19	27.5	22	17	6	M10 x 1.25	M6	13	1/8"	5.5	6	6	4.7	32.5	12	10	3	30
40	159	54	105	35	33	21	32	24	17	7	M12 x 1.25	M6	17	1/4"	6	7.5	8.5	5.3	38	16	13	3.5	35
50	175	69	106	40	42	27	31	32	23	8	M16 x 1.5	M8	15.5	1/4"	7.5	6.5	9.5	6.5	46.5	20	17	3.5	40
63	190	69	121	45	42	27	33	32	23	8	M16 x 1.5	M8	16.5	3/8"	7.5	7.5	11.5	7.5	56.5	20	17	4	45
80	214	86	128	45	50	33	33	40	26	10	M20 x 1.5	M10	16.5	3/8"	9	7.5	13.5	9.5	72	25	22	4	45
100	229	91	138	55	55	36	37	40	26	10	M20 x 1.5	M10	18.5	1/2"	9.5	8.5	13.5	11.5	89	25	22	4	55
125	279	119	160	60	74	45	46	54	41	13.5	M27 x 2	M12	23	1/2"	14	12	14	140	110	32	27	4	60
160	332	152	180	65	94	58	50	72	55	18	M36 x 2	M16	25	3/4"	15	12	20	180	140	40	36	4	65
200	347	167	180	75	100	67	50	72	55	18	M36 x 2	M16	25	3/4"	15	12	20	220	175	40	36	5	75

Binnenstructuur

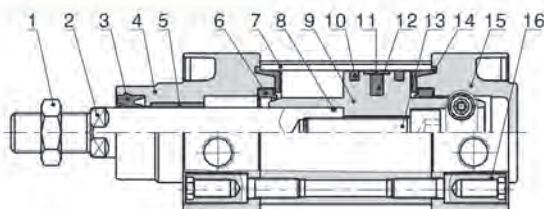

Nr.	Onderdeel	Materiaal	Nr.	Onderdeel	Materiaal
1	Zuigerstangmoer	Koolstofstaal	9	Zuiger	Aluminiumlegering
2	Zuigerstang	Roestvast staal	10	O-ring zuiger	TPU
3	Pakking kap voorzijde	TPU	11	Slijtring	Slijtvast materiaal
4	Kap voorzijde	Aluminiumlegering	12	Magneet	Boring < ø100: Plastic Overige: Rubber
5	Geleider	Slijtvast materiaal	13	Bout	Koolstofstaal
6	O-ring buffer	TPU	14	Buffer pakking	TPU
7	Buis	Aluminiumlegering	15	Kap achterzijde	Aluminiumlegering
8	O-ring stang	NBR	16	Moer trekstang	Koolstofstaal

PERSLUCHTCILINDERS

ISO 15552 cilinders

Werktemperatuur:
-20°C tot +80°C

Werkdruk:
1 tot 10 bar

Medium:
Geconditioneerde perslucht, gefilterd (40µm) en gesmeerd.
Met instelbare buffering
Volledige technische specificaties worden op aanvraag verstrekt

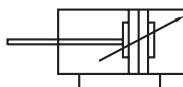

Tech Data
3011

Magnetisch - dubbelwerkend - instelbare buffering

0334	mm	mm	BSPB	Rod Thread	€
KF-32BX25-S-G	32	25	1/8"	M10 x 1,25	62.10
KF-32BX50-S-G	32	50	1/8"	M10 x 1,25	64.10
KF-32BX75-S-G	32	75	1/8"	M10 x 1,25	65.45
KF-32BX80-S-G	32	80	1/8"	M10 x 1,25	66.70
KF-32BX100-S-G	32	100	1/8"	M10 x 1,25	68.05
KF-32BX125-S-G	32	125	1/8"	M10 x 1,25	71.70
KF-32BX150-S-G	32	150	1/8"	M10 x 1,25	73.65
KF-32BX160-S-G	32	160	1/8"	M10 x 1,25	74.45
KF-32BX175-S-G	32	175	1/8"	M10 x 1,25	75.95
KF-32BX200-S-G	32	200	1/8"	M10 x 1,25	78.75
KF-32BX250-S-G	32	250	1/8"	M10 x 1,25	84.40
KF-32BX300-S-G	32	300	1/8"	M10 x 1,25	87.85
KF-32BX350-S-G	32	350	1/8"	M10 x 1,25	92.85
KF-32BX400-S-G	32	400	1/8"	M10 x 1,25	99.85
KF-32BX450-S-G	32	450	1/8"	M10 x 1,25	101.55
KF-32BX500-S-G	32	500	1/8"	M10 x 1,25	109.15
KF-40BX25-S-G	40	25	1/4"	M12 x 1,25	68.55
KF-40BX50-S-G	40	50	1/4"	M12 x 1,25	73.20
KF-40BX75-S-G	40	75	1/4"	M12 x 1,25	75.00
KF-40BX80-S-G	40	80	1/4"	M12 x 1,25	78.95
KF-40BX100-S-G	40	100	1/4"	M12 x 1,25	80.60
KF-40BX125-S-G	40	125	1/4"	M12 x 1,25	83.40
KF-40BX150-S-G	40	150	1/4"	M12 x 1,25	85.60
KF-40BX160-S-G	40	160	1/4"	M12 x 1,25	89.90
KF-40BX175-S-G	40	175	1/4"	M12 x 1,25	90.30
KF-40BX200-S-G	40	200	1/4"	M12 x 1,25	91.25
KF-40BX250-S-G	40	250	1/4"	M12 x 1,25	100.90
KF-40BX300-S-G	40	300	1/4"	M12 x 1,25	106.75
KF-40BX350-S-G	40	350	1/4"	M12 x 1,25	110.65
KF-40BX400-S-G	40	400	1/4"	M12 x 1,25	120.00
KF-40BX450-S-G	40	450	1/4"	M12 x 1,25	126.80
KF-40BX500-S-G	40	500	1/4"	M12 x 1,25	133.65
KF-40BX600-S-G	40	600	1/4"	M12 x 1,25	144.50
KF-40BX700-S-G	40	700	1/4"	M12 x 1,25	162.75
KF-40BX800-S-G	40	800	1/4"	M12 x 1,25	172.50
KF-50BX25-S-G	50	25	1/4"	M16 x 1,5	94.35
KF-50BX50-S-G	50	50	1/4"	M16 x 1,5	96.80
KF-50BX75-S-G	50	75	1/4"	M16 x 1,5	102.55
KF-50BX80-S-G	50	80	1/4"	M16 x 1,5	108.55
KF-50BX100-S-G	50	100	1/4"	M16 x 1,5	109.15
KF-50BX125-S-G	50	125	1/4"	M16 x 1,5	109.95
KF-50BX150-S-G	50	150	1/4"	M16 x 1,5	115.70
KF-50BX160-S-G	50	160	1/4"	M16 x 1,5	121.55
KF-50BX175-S-G	50	175	1/4"	M16 x 1,5	121.85
KF-50BX200-S-G	50	200	1/4"	M16 x 1,5	126.25
KF-50BX250-S-G	50	250	1/4"	M16 x 1,5	135.20
KF-50BX300-S-G	50	300	1/4"	M16 x 1,5	143.75
KF-50BX350-S-G	50	350	1/4"	M16 x 1,5	148.95

0334	mm	mm	BSPB	Rod Thread	€
KF-50BX400-S-G	50	400	1/4"	M16 x 1,5	161.55
KF-50BX450-S-G	50	450	1/4"	M16 x 1,5	170.35
KF-50BX500-S-G	50	500	1/4"	M16 x 1,5	175.10
KF-50BX600-S-G	50	600	1/4"	M16 x 1,5	193.40
KF-50BX700-S-G	50	700	1/4"	M16 x 1,5	212.25
KF-50BX800-S-G	50	800	1/4"	M16 x 1,5	230.90
KF-50BX900-S-G	50	900	1/4"	M16 x 1,5	249.50
KF-50BX1000-S-G	50	1000	1/4"	M16 x 1,5	268.05
KF-63BX25-S-G	63	25	3/8"	M16 x 1,5	108.45
KF-63BX50-S-G	63	50	3/8"	M16 x 1,5	111.45
KF-63BX75-S-G	63	75	3/8"	M16 x 1,5	117.75
KF-63BX80-S-G	63	80	3/8"	M16 x 1,5	120.80
KF-63BX100-S-G	63	100	3/8"	M16 x 1,5	121.85
KF-63BX125-S-G	63	125	3/8"	M16 x 1,5	130.25
KF-63BX150-S-G	63	150	3/8"	M16 x 1,5	135.10
KF-63BX160-S-G	63	160	3/8"	M16 x 1,5	136.65
KF-63BX175-S-G	63	175	3/8"	M16 x 1,5	140.00
KF-63BX200-S-G	63	200	3/8"	M16 x 1,5	145.85
KF-63BX250-S-G	63	250	3/8"	M16 x 1,5	154.20
KF-63BX300-S-G	63	300	3/8"	M16 x 1,5	160.10
KF-63BX350-S-G	63	350	3/8"	M16 x 1,5	171.70
KF-63BX400-S-G	63	400	3/8"	M16 x 1,5	176.60
KF-63BX450-S-G	63	450	3/8"	M16 x 1,5	188.35
KF-63BX500-S-G	63	500	3/8"	M16 x 1,5	197.80
KF-63BX600-S-G	63	600	3/8"	M16 x 1,5	217.90
KF-63BX700-S-G	63	700	3/8"	M16 x 1,5	237.90
KF-63BX800-S-G	63	800	3/8"	M16 x 1,5	258.00
KF-63BX900-S-G	63	900	3/8"	M16 x 1,5	278.05
KF-63BX1000-S-G	63	1000	3/8"	M16 x 1,5	298.10
KF-80BX25-S-G	80	25	3/8"	M20 x 1,5	154.15
KF-80BX50-S-G	80	50	3/8"	M20 x 1,5	163.95
KF-80BX75-S-G	80	75	3/8"	M20 x 1,5	167.55
KF-80BX80-S-G	80	80	3/8"	M20 x 1,5	171.85
KF-80BX100-S-G	80	100	3/8"	M20 x 1,5	180.10
KF-80BX125-S-G	80	125	3/8"	M20 x 1,5	180.35
KF-80BX150-S-G	80	150	3/8"	M20 x 1,5	191.65
KF-80BX160-S-G	80	160	3/8"	M20 x 1,5	201.95
KF-80BX175-S-G	80	175	3/8"	M20 x 1,5	202.20
KF-80BX200-S-G	80	200	3/8"	M20 x 1,5	203.60
KF-80BX250-S-G	80	250	3/8"	M20 x 1,5	223.95
KF-80BX300-S-G	80	300	3/8"	M20 x 1,5	239.40
KF-80BX350-S-G	80	350	3/8"	M20 x 1,5	254.45
KF-80BX400-S-G	80	400	3/8"	M20 x 1,5	262.45
KF-80BX450-S-G	80	450	3/8"	M20 x 1,5	286.15
KF-80BX500-S-G	80	500	3/8"	M20 x 1,5	298.75
KF-80BX600-S-G	80	600	3/8"	M20 x 1,5	322.20
KF-80BX700-S-G	80	700	3/8"	M20 x 1,5	362.65
KF-80BX800-S-G	80	800	3/8"	M20 x 1,5	383.75

ISO 15552 cilinders

Werktemperatuur:
-20°C tot +80°C

Werkdruk:
1 tot 10 bar

Medium:

Geconditioneerde perslucht, gefilterd (40µm) en gesmeerd.

Met instelbare buffering

Volledige technische specificaties worden op aanvraag verstrekt

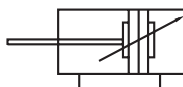

Tech Data
3011

Magnetisch - dubbelwerkend - instelbare buffering

0334	Ø mm	mm	BSPP	Rod Thread	€
KF-80BX900-S-G	80	900	3/8"	M20 x 1,5	414.40
KF-80BX1000-S-G	80	1000	3/8"	M20 x 1,5	444.95
KF-100BX25-S-G	100	25	1/2"	M20 x 1,5	187.15
KF-100BX50-S-G	100	50	1/2"	M20 x 1,5	196.10
KF-100BX75-S-G	100	75	1/2"	M20 x 1,5	206.10
KF-100BX80-S-G	100	80	1/2"	M20 x 1,5	206.55
KF-100BX100-S-G	100	100	1/2"	M20 x 1,5	210.80
KF-100BX125-S-G	100	125	1/2"	M20 x 1,5	222.30
KF-100BX150-S-G	100	150	1/2"	M20 x 1,5	232.25
KF-100BX160-S-G	100	160	1/2"	M20 x 1,5	232.35
KF-100BX175-S-G	100	175	1/2"	M20 x 1,5	241.30
KF-100BX200-S-G	100	200	1/2"	M20 x 1,5	249.05
KF-100BX250-S-G	100	250	1/2"	M20 x 1,5	266.70
KF-100BX300-S-G	100	300	1/2"	M20 x 1,5	273.25
KF-100BX350-S-G	100	350	1/2"	M20 x 1,5	300.85
KF-100BX400-S-G	100	400	1/2"	M20 x 1,5	319.30
KF-100BX450-S-G	100	450	1/2"	M20 x 1,5	327.80
KF-100BX500-S-G	100	500	1/2"	M20 x 1,5	344.85
KF-100BX600-S-G	100	600	1/2"	M20 x 1,5	380.15
KF-100BX700-S-G	100	700	1/2"	M20 x 1,5	415.70
KF-100BX800-S-G	100	800	1/2"	M20 x 1,5	450.95
KF-100BX900-S-G	100	900	1/2"	M20 x 1,5	486.25
KF-100BX1000-S-G	100	1000	1/2"	M20 x 1,5	521.50
KF-125BX25-S-G	125	25	1/2"	M27 x 2	310.25
KF-125BX50-S-G	125	50	1/2"	M27 x 2	324.20
KF-125BX75-S-G	125	75	1/2"	M27 x 2	338.15
KF-125BX80-S-G	125	80	1/2"	M27 x 2	352.35
KF-125BX100-S-G	125	100	1/2"	M27 x 2	359.60
KF-125BX125-S-G	125	125	1/2"	M27 x 2	367.40
KF-125BX150-S-G	125	150	1/2"	M27 x 2	382.80
KF-125BX160-S-G	125	160	1/2"	M27 x 2	398.15
KF-125BX175-S-G	125	175	1/2"	M27 x 2	400.90
KF-125BX200-S-G	125	200	1/2"	M27 x 2	412.05
KF-125BX250-S-G	125	250	1/2"	M27 x 2	442.70
KF-125BX300-S-G	125	300	1/2"	M27 x 2	471.95
KF-125BX350-S-G	125	350	1/2"	M27 x 2	502.50
KF-125BX400-S-G	125	400	1/2"	M27 x 2	531.85
KF-125BX450-S-G	125	450	1/2"	M27 x 2	562.30
KF-125BX500-S-G	125	500	1/2"	M27 x 2	591.55
KF-125BX600-S-G	125	600	1/2"	M27 x 2	652.80
KF-125BX700-S-G	125	700	1/2"	M27 x 2	713.85
KF-125BX800-S-G	125	800	1/2"	M27 x 2	774.90
KF-125BX900-S-G	125	900	1/2"	M27 x 2	836.00

0334	Ø mm	mm	BSPP	Rod Thread	€
KF-125BX1000-S-G	125	1000	1/2"	M27 x 2	897.25
KF-160BX25-S-G	160	25	3/4"	M36 x 2	469.10
KF-160BX50-S-G	160	50	3/4"	M36 x 2	489.80
KF-160BX75-S-G	160	75	3/4"	M36 x 2	511.55
KF-160BX80-S-G	160	80	3/4"	M36 x 2	533.40
KF-160BX100-S-G	160	100	3/4"	M36 x 2	534.55
KF-160BX125-S-G	160	125	3/4"	M36 x 2	556.55
KF-160BX150-S-G	160	150	3/4"	M36 x 2	579.55
KF-160BX160-S-G	160	160	3/4"	M36 x 2	602.70
KF-160BX175-S-G	160	175	3/4"	M36 x 2	613.85
KF-160BX200-S-G	160	200	3/4"	M36 x 2	624.55
KF-160BX250-S-G	160	250	3/4"	M36 x 2	670.80
KF-160BX300-S-G	160	300	3/4"	M36 x 2	714.45
KF-160BX350-S-G	160	350	3/4"	M36 x 2	760.55
KF-160BX400-S-G	160	400	3/4"	M36 x 2	805.60
KF-160BX450-S-G	160	450	3/4"	M36 x 2	851.65
KF-160BX500-S-G	160	500	3/4"	M36 x 2	896.65
KF-160BX600-S-G	160	600	3/4"	M36 x 2	990.30
KF-160BX700-S-G	160	700	3/4"	M36 x 2	1084.00
KF-160BX800-S-G	160	800	3/4"	M36 x 2	1177.60
KF-160BX900-S-G	160	900	3/4"	M36 x 2	1271.20
KF-160BX1000-S-G	160	1000	3/4"	M36 x 2	1365.00
KF-200BX25-S-G	200	25	3/4"	M36 x 2	601.95
KF-200BX50-S-G	200	50	3/4"	M36 x 2	627.60
KF-200BX75-S-G	200	75	3/4"	M36 x 2	655.70
KF-200BX80-S-G	200	80	3/4"	M36 x 2	683.80
KF-200BX100-S-G	200	100	3/4"	M36 x 2	697.50
KF-200BX125-S-G	200	125	3/4"	M36 x 2	711.95
KF-200BX150-S-G	200	150	3/4"	M36 x 2	740.05
KF-200BX160-S-G	200	160	3/4"	M36 x 2	768.20
KF-200BX175-S-G	200	175	3/4"	M36 x 2	783.45
KF-200BX200-S-G	200	200	3/4"	M36 x 2	796.30
KF-200BX250-S-G	200	250	3/4"	M36 x 2	852.60
KF-200BX300-S-G	200	300	3/4"	M36 x 2	908.85
KF-200BX350-S-G	200	350	3/4"	M36 x 2	965.15
KF-200BX400-S-G	200	400	3/4"	M36 x 2	1021.40
KF-200BX450-S-G	200	450	3/4"	M36 x 2	1077.70
KF-200BX500-S-G	200	500	3/4"	M36 x 2	1133.75
KF-200BX600-S-G	200	600	3/4"	M36 x 2	1248.95
KF-200BX700-S-G	200	700	3/4"	M36 x 2	1363.95
KF-200BX800-S-G	200	800	3/4"	M36 x 2	1481.50
KF-200BX900-S-G	200	900	3/4"	M36 x 2	1599.10
KF-200BX1000-S-G	200	1000	3/4"	M36 x 2	1716.65

KELM™ pneumatiek

Hydrauliek

Snelkoppelingen

Afsluiters

Roestvast staal

Fittingen

Luchtconditionering

Gereedschap

Pneumatiek

Diversen

Walleabele fittingen & staal

Ringleidingssystemen

Slangen

Compressoren

ISO 15552 bevestigingen

Tech Data
3012



Flensbevestiging voor/achter 'FA'

0334	Ø mm	€
F-KF32FA	32	8.15
F-KF40FA	40	8.55
F-KF50FA	50	10.05
F-KF63FA	63	12.95
F-KF80FA	80	19.95
F-KF100FA	100	23.55
F-KF125FA	125	63.85
F-KF160FA	160	104.25
F-KF200FA	200	148.10

Tech Data
3013



Zwenktrapbevestiging voor 'FTC'

0334	Ø mm	€
F-KF32FTC	32	25.20
F-KF40FTC	40	25.50
F-KF50FTC	50	34.95
F-KF63FTC	63	41.45
F-KF80FTC	80	51.00
F-KF100FTC	100	82.00
F-KF125FTC	125	113.35
F-KF160FTC	160	197.75
F-KF200FTC	200	300.00

Tech Data
3014



Zwenktrap/gaffelbevestiging voor 'TF'

0334	Ø mm	€
F-KF32TF	32	15.55
F-KF40TF	40/50	25.20
F-KF63TF	63/80	44.05
F-KF125TF	100/125	102.15
F-KF160TF	160	182.90
F-KF200TF	200	220.80

Tech Data
3015



Zwenktrapsteun 'TM'

0334	Ø mm	€
F-KF32TM	32	12.60
F-KF40TM	40/50	15.55
F-KF63TM	63/80	22.00
F-KF125TM	100/125	31.35
F-KF160TM	160/200	45.40

Tech Data
3016



Enkel achterscharnier 'CA'

0334	Ø mm	€
F-KF32CA	32	8.80
F-KF40CA	40	9.15
F-KF50CA	50	11.20
F-KF63CA	63	12.50
F-KF80CA	80	19.25
F-KF100CA	100	23.45
F-KF125CA	125	71.15
F-KF160CA	160	107.15
F-KF200CA	200	142.45

Tech Data
3017



Dubbel achterscharnier 'CB'

0334	Ø mm	€
F-KF32CB	32	10.55
F-KF40CB	40	11.55
F-KF50CB	50	14.50
F-KF63CB	63	15.50
F-KF80CB	80	22.50
F-KF100CB	100	25.30
F-KF125CB	125	87.05
F-KF160CB	160	120.80
F-KF200CB	200	160.80

ISO 15552 bevestigingen

Tech Data
3018



Bevestigingssteun achter 'CR'

0334	Ø mm	€
F-KF32CR	32	10.70
F-KF40CR	40	11.45
F-KF50CR	50	13.40
F-KF63CR	63	14.85
F-KF80CR	80	22.60
F-KF100CR	100	29.20
F-KF125CR	125	89.05
F-KF160CR	160	128.45
F-KF200CR	200	174.05

Tech Data
3019



Bevestigingsvoet 'LB' (paar)

0334	Ø mm	€
F-KF32LB	32	5.65
F-KF40LB	40	6.25
F-KF50LB	50	6.85
F-KF63LB	63	8.45
F-KF80LB	80	9.25
F-KF100LB	100	10.70
F-KF125LB	125	42.95
F-KF160LB	160	66.95
F-KF200LB	200	95.65

Tech Data
3020



Zuigerstang gaffel 'YI'

0334	Ø mm	€
F-M10125YI	32	M10 x 1,25 8.45
F-M12125YI	40	M12 x 1,25 12.75
F-M16150YI	50/63	M16 x 1,5 20.10
F-M20150YI	80/100	M20 x 1,5 28.20
F-M27200YI	125	M27 x 2 41.95
F-M36200YI	160/200	M36 x 2 61.20

Tech Data
3021



Zuigerstang gaffel 'I'

0334	Ø mm	€
F-M10125II	25/32	M10 x 1,25 6.20
F-M12125II	40	M12 x 1,25 8.20
F-M16150II	50/63	M16 x 1,5 11.95
F-M20150II	80/100	M20 x 1,5 20.40
F-M27200II	125	M27 x 2 27.75
F-M36200II	160/200	M36 x 2 44.65

Tech Data
3022



Uitlijnkop 'F'

0334	Ø mm	€
F-M10125F	25/32	M10 x 1,25 18.40
F-M12125F	40	M12 x 1,25 19.90
F-M16150F	50/63	M16 x 1,5 35.70
F-M20150F	80/100	M20 x 1,5 51.70

Tech Data
3023



Universele kogelstangkop 'U'

0334	Ø mm	€
F-M10125U	25/32	M10 x 1,25 9.65
F-M12125U	40	M12 x 1,25 11.35
F-M16150U	50/63	M16 x 1,5 20.20
F-M20150U	80/100	M20 x 1,5 32.20
F-M27200U	125	M27 x 2 61.80
F-M36200U	160/200	M36 x 2 93.40

KELM™
pneumatiek

Hydrauliek

Snel-
koppelingen

Afsluiters

Roestvast
staal

Fittingen

Lucht-
conditionering

Gereedschap

Pneumatiek

Diversen

Malleabele
fittings
& staal

Ringleiding-
systemen

Slangen

Compressoren

ISO 15552 magneetschakelaars

Tech Data
3024



Tweepolig - NO met LED

0334	Ø mm		€
CS1-B1	32/40	5-240V AC/DC	20.80
CS1-B2	50/63	5-240V AC/DC	20.80
CS1-B3	80	5-240V AC/DC	20.80
CS1-B4	100	5-240V AC/DC	20.80
CS1-B5	125	5-240V AC/DC	20.80
CS1-B6	160	5-240V AC/DC	20.80
CS1-B7	200	5-240V AC/DC	20.80

Tech Data
3025



Driepolig - NO met LED - ingaande stroming NPN

0334	Ø mm		€
CS1-B1N	32/40	5-30V DC	35.85
CS1-B2N	50/63	5-30V DC	35.85
CS1-B3N	80	5-30V DC	35.85
CS1-B4N	100	5-30V DC	35.85
CS1-B5N	125	5-30V DC	35.85
CS1-B6N	160	5-30V DC	35.85
CS1-B7N	200	5-30V DC	35.85

Tech Data
3026



Driepolig - NO met LED - uitgaande stroming PNP

0334	Ø mm		€
CS1-B1P	32/40	5-30V DC	35.85
CS1-B2P	50/63	5-30V DC	35.85
CS1-B3P	80	5-30V DC	35.85
CS1-B4P	100	5-30V DC	35.85
CS1-B5P	125	5-30V DC	35.85
CS1-B6P	160	5-30V DC	35.85
CS1-B7P	200	5-30V DC	35.85

ISO 15552 revisieset

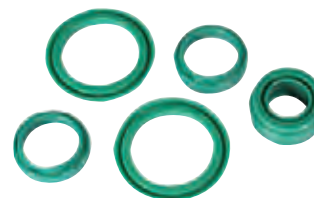

Standaard

0334	Ø	€
KFRK-32	32	8.35
KFRK-40	40	10.55
KFRK-50	50	12.55
KFRK-63	63	14.95
KFRK-80	80	18.95
KFRK-100	100	23.65
KFRK-125	125	29.40
KFRK-160	160	36.20
KFRK-200	200	44.10

KELM™
pneumatiek

Hydrauliek

Snel-
koppelingen

Afsluiters

Roestvast
staal

Fittingen

Lucht-
conditionering

Gereedschap

Pneumatiek

Diversen

Malleabele
fittingen
& staal

Ringleiding-
systemen

Slangen

Compressoren

COMPACTE PERSLUCHTCILINDER



ACCESSOIRES & BEVESTIGING SELECTIE

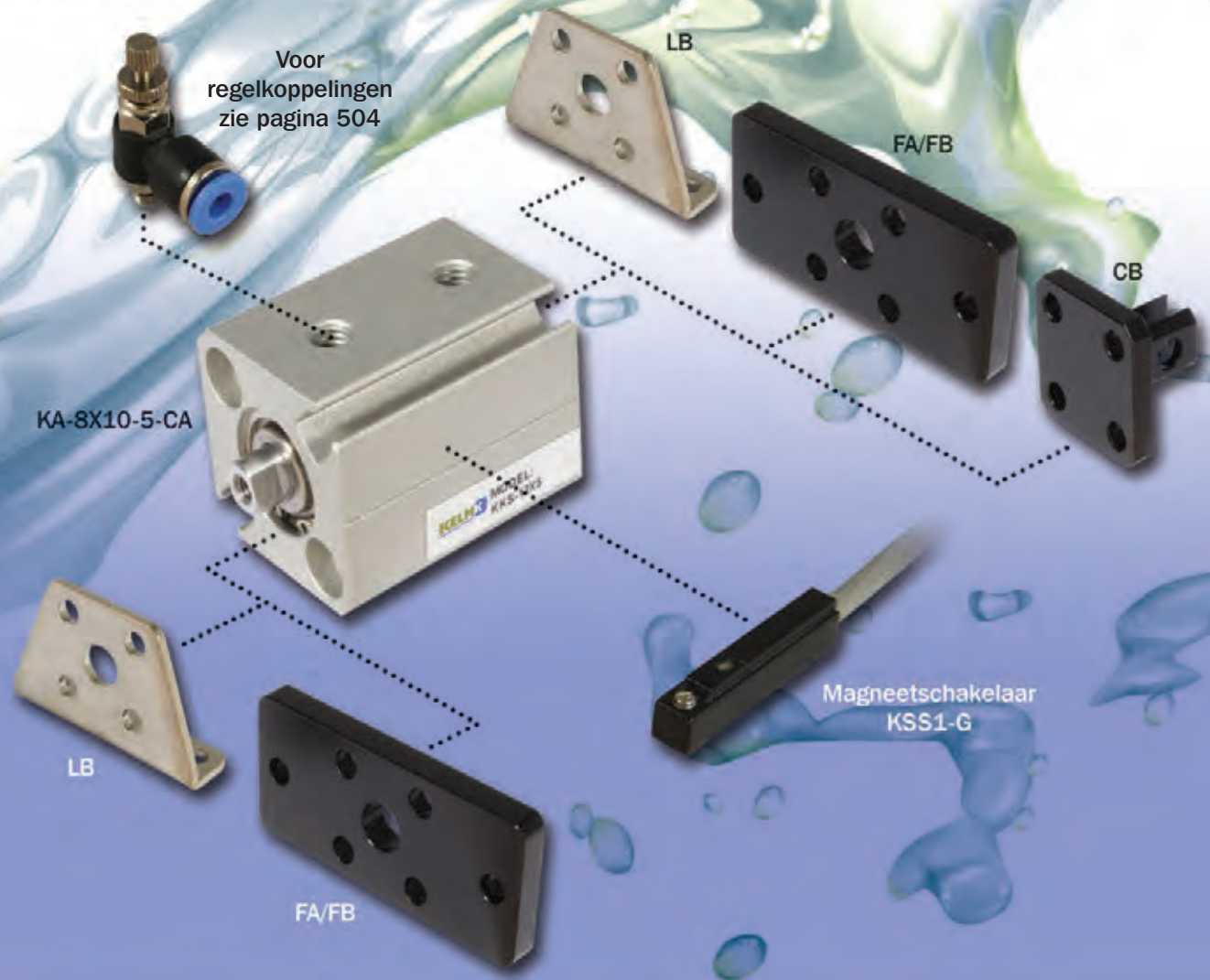

Voor
regelkoppelingen
zie pagina 504

KA-8X10-5-CA

LB

FA/FB

CB

LB

Magneetschakelaar
KSS1-G

FA/FB

Compactcilinders

CB - Gaffelscharnier achter
FA/FB - Flensbevestiging
voor/achter

LB - Bevestigingsvoet (paar)
Tweepolige magneetschakelaars
N/O/ met LED

*Cilinders op pagina 483
Bevestigingen op pagina 485
Magneetschakelaars op pagina 485*

KKS serie

Afmetingen

ø12 & ø16

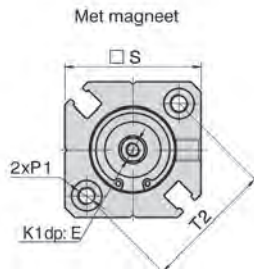

ø20 & ø25

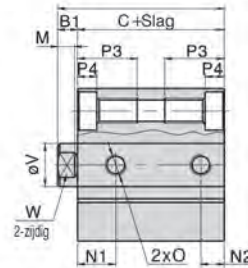
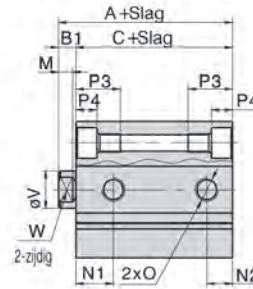
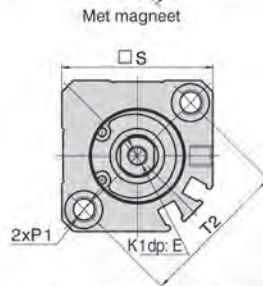

Model	Met magneet		B1	D	E	K1	M	N1		N2	
	Boring	A						Zonder magneet	Met magneet	Zonder magneet	Met magneet
12	31.5	28	3.5	-	6	M3 x 0.5	3.5	7.5	9	5	7
16	34	30.5	2.5	-	8	M4 x 0.7	3	8	9.5	5.5	-
20	38	31.5	4.5	-	7	M5 x 0.8	4	9	9.5	5.5	-
25	37.5	32.5	5	25	12	M6 x 1.0	4.5	11	-	5.5	-

Boring	O	P1	P3	P4	S	T1	T2	V	W		
12	M5 x 0.8	2-zijdig; ø6.5	Draad: M4 x 0.7	Gat: ø3.4	11	3.5	25	15.5	22	6	5
16	M5 x 0.8	2-zijdig; ø6.3	Draad: M4 x 0.7	Gat: ø3.4	11	3.5	29	23	28	8	6
20	M5 x 0.8	2-zijdig; ø9	Draad: M6 x 1.0	Gat: ø5.2	17	7	36	25.5	36	10	8
25	M5 x 0.8	2-zijdig; ø9	Draad: M6 x 1.0	Gat: ø5.2	17	7	40	28	40	12	10

Afmetingen

ø32 to ø100
(Slag ≤ 100)

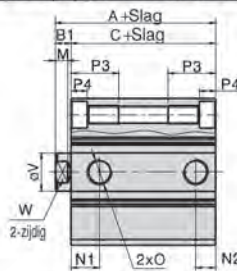
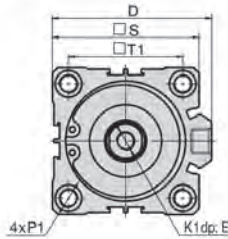

Model	Met magneet		B1	D	E	K1	M	N1		N2		
	Boring	A						Zonder magneet	Met magneet	Zonder magneet	Met magneet	
32	St-5	40	33	7	49.5	13	M8 x 1.25	6	7.5	10.5	6.5	7.5
	St->6	-	-	-	-	-	-	-	10.5	-	7.5	-
40	46.5	39.5	7	57	13	M8 x 1.25	6	11	-	8	-	-
50	St-5	48.5	40.5	8	71	15	M10 x 1.5	6.5	9	10.5	9	10.5
	St->6	-	-	-	-	-	-	-	10.5	-	10.5	-
65	St-5	54	46	8	84	15	M10 x 1.5	6.5	14	15	9.5	10.5
	St->6	-	-	-	-	-	-	-	15	-	10.5	-
80	63.5	53.5	10	104	20	M16 x 2.0	8.5	16	-	14	-	-
100	75	63	12	123.5	26	M20 x 2.5	9.5	20	-	17.5	-	-

Boring	O	P1	P3	P4	S	T1	T2	V	W		
32	1/8"	2-zijdig; ø9	Draad: M6 x 1.0	Gat: ø5.2	17	7	45	34	-	16	14
40	1/8"	2-zijdig; ø9	Draad: M6 x 1.0	Gat: ø5.2	17	7	53	40	-	16	14
50	1/4"	2-zijdig; ø11	Draad: M8 x 1.25	Gat: ø6.5	22	8	64	50	-	20	17
63	1/4"	2-zijdig; ø14	Draad: M10 x 1.5	Gat: ø8.7	28.5	10.5	77	60	-	20	17
80	3/8"	2-zijdig; ø17.5	Draad: M12 x 1.75	Gat: ø10.7	35.5	13.5	98	77	-	25	22
100	3/8"	2-zijdig; ø17.5	Draad: M12 x 1.75	Gat: ø10.7	35.5	13.5	117	94	-	32	27

Binnenstructuur

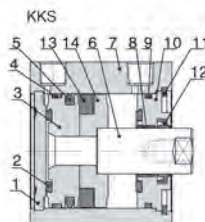

Nr.	Onderdeel	Materiaal
1	Kap achterzijde	12 & 16 - Aluminiumlegering
2	Buffer	TPU NBR
3	Zuiger	Messing Aluminiumlegering
4	Slijtring	Slijfvast materiaal
5	O-ring zuiger	NBR
6	Zuigerstang	Koolstofstaal 20um verchroomd
7	Huis	Aluminiumlegering
8	Geleider	Slijfvast materiaal
9	Kap pakking	NBR
10	Kap voorzijde	Messing Aluminiumlegering
11	C clip	Verenstaal
12	Pakking kap voorzijde	NBR
13	Magneet	Gesinterd metaal Plastic
14	Magneethouder	Messing Aluminiumlegering

Compactcilinders

Werktemperatuur:
-20°C tot +80°C

Werkdruk:
1 tot 10 bar

Medium:

Geconditioneerde perslucht, gefilterd (40µm) en gesmeerd.

Met kunststof buffers

Behuizing: aluminium

Afdichtingen: NBR

Volledige technische specificaties worden op aanvraag verstrekt

Tech Data
3027

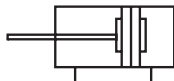

Magnetisch - dubbelwerkend

0334					€
KKS-12X5	12	5	M5 x 0,8	M3 x 0,5	33.65
KKS-12X10	12	10	M5 x 0,8	M3 x 0,5	35.85
KKS-12X15	12	15	M5 x 0,8	M3 x 0,5	36.70
KKS-12X20	12	20	M5 x 0,8	M3 x 0,5	39.05
KKS-12X25	12	25	M5 x 0,8	M3 x 0,5	39.30
KKS-12X30	12	30	M5 x 0,8	M3 x 0,5	40.55
KKS-12X35	12	35	M5 x 0,8	M3 x 0,5	41.95
KKS-12X40	12	40	M5 x 0,8	M3 x 0,5	43.45
KKS-12X45	12	45	M5 x 0,8	M3 x 0,5	44.40
KKS-12X50	12	50	M5 x 0,8	M3 x 0,5	46.50
KKS-16X5	16	5	M5 x 0,8	M4 x 0,7	34.35
KKS-16X10	16	10	M5 x 0,8	M4 x 0,7	35.95
KKS-16X15	16	15	M5 x 0,8	M4 x 0,7	36.70
KKS-16X20	16	20	M5 x 0,8	M4 x 0,7	38.20
KKS-16X25	16	25	M5 x 0,8	M4 x 0,7	39.30
KKS-16X30	16	30	M5 x 0,8	M4 x 0,7	40.55
KKS-16X35	16	35	M5 x 0,8	M4 x 0,7	41.95
KKS-16X40	16	40	M5 x 0,8	M4 x 0,7	43.45
KKS-16X45	16	45	M5 x 0,8	M4 x 0,7	44.40
KKS-16X50	16	50	M5 x 0,8	M4 x 0,7	46.50
KKS-16X55	16	55	M5 x 0,8	M4 x 0,7	50.30
KKS-16X60	16	60	M5 x 0,8	M4 x 0,7	51.40
KKS-20X5	20	5	M5 x 0,8	M5 x 0,8	35.45
KKS-20X10	20	10	M5 x 0,8	M5 x 0,8	36.35
KKS-20X15	20	15	M5 x 0,8	M5 x 0,8	37.05
KKS-20X20	20	20	M5 x 0,8	M5 x 0,8	38.05
KKS-20X25	20	25	M5 x 0,8	M5 x 0,8	39.35
KKS-20X30	20	30	M5 x 0,8	M5 x 0,8	40.55
KKS-20X35	20	35	M5 x 0,8	M5 x 0,8	42.10
KKS-20X40	20	40	M5 x 0,8	M5 x 0,8	43.65
KKS-20X45	20	45	M5 x 0,8	M5 x 0,8	45.05
KKS-20X50	20	50	M5 x 0,8	M5 x 0,8	45.25
KKS-20X60	20	60	M5 x 0,8	M5 x 0,8	49.40
KKS-20X70	20	70	M5 x 0,8	M5 x 0,8	52.80
KKS-20X75	20	75	M5 x 0,8	M5 x 0,8	55.40
KKS-20X80	20	80	M5 x 0,8	M5 x 0,8	58.00
KKS-20X90	20	90	M5 x 0,8	M5 x 0,8	63.05
KKS-20X100	20	100	M5 x 0,8	M5 x 0,8	68.30
KKS-25X5	25	5	M5 x 0,8	M6 x 1	40.25
KKS-25X10	25	10	M5 x 0,8	M6 x 1	41.95
KKS-25X15	25	15	M5 x 0,8	M6 x 1	42.10
KKS-25X20	25	20	M5 x 0,8	M6 x 1	43.05
KKS-25X25	25	25	M5 x 0,8	M6 x 1	43.55
KKS-25X30	25	30	M5 x 0,8	M6 x 1	45.50
KKS-25X35	25	35	M5 x 0,8	M6 x 1	46.95

Raadpleeg de volgende pagina voor andere maten in deze reeks

0334					€
KKS-25X40	25	40	M5 x 0,8	M6 x 1	48.10
KKS-25X45	25	45	M5 x 0,8	M6 x 1	49.15
KKS-25X50	25	50	M5 x 0,8	M6 x 1	50.15
KKS-25X60	25	60	M5 x 0,8	M6 x 1	53.25
KKS-25X70	25	70	M5 x 0,8	M6 x 1	55.55
KKS-25X75	25	75	M5 x 0,8	M6 x 1	57.50
KKS-25X80	25	80	M5 x 0,8	M6 x 1	59.95
KKS-25X90	25	90	M5 x 0,8	M6 x 1	65.20
KKS-25X100	25	100	M5 x 0,8	M6 x 1	71.15
KKS-32X5	32	5	1/8"	M8 x 1,25	46.25
KKS-32X10	32	10	1/8"	M8 x 1,25	48.15
KKS-32X15	32	15	1/8"	M8 x 1,25	49.65
KKS-32X20	32	20	1/8"	M8 x 1,25	51.25
KKS-32X25	32	25	1/8"	M8 x 1,25	52.90
KKS-32X30	32	30	1/8"	M8 x 1,25	53.50
KKS-32X35	32	35	1/8"	M8 x 1,25	55.50
KKS-32X40	32	40	1/8"	M8 x 1,25	57.45
KKS-32X45	32	45	1/8"	M8 x 1,25	59.45
KKS-32X50	32	50	1/8"	M8 x 1,25	62.60
KKS-32X60	32	60	1/8"	M8 x 1,25	65.00
KKS-32X70	32	70	1/8"	M8 x 1,25	69.05
KKS-32X75	32	75	1/8"	M8 x 1,25	71.45
KKS-32X80	32	80	1/8"	M8 x 1,25	75.00
KKS-32X90	32	90	1/8"	M8 x 1,25	80.05
KKS-32X100	32	100	1/8"	M8 x 1,25	85.60
KKS-32X125	32	125	1/8"	M8 x 1,25	106.90
KKS-32X150	32	150	1/8"	M8 x 1,25	121.05
KKS-32X175	32	175	1/8"	M8 x 1,25	135.15
KKS-32X200	32	200	1/8"	M8 x 1,25	153.00
KKS-32X250	32	250	1/8"	M8 x 1,25	185.65
KKS-40X5	40	5	1/8"	M8 x 1,25	54.10
KKS-40X10	40	10	1/8"	M8 x 1,25	54.40
KKS-40X15	40	15	1/8"	M8 x 1,25	58.90
KKS-40X20	40	20	1/8"	M8 x 1,25	59.20
KKS-40X25	40	25	1/8"	M8 x 1,25	60.35
KKS-40X30	40	30	1/8"	M8 x 1,25	63.55
KKS-40X35	40	35	1/8"	M8 x 1,25	65.45
KKS-40X40	40	40	1/8"	M8 x 1,25	66.70
KKS-40X45	40	45	1/8"	M8 x 1,25	69.55
KKS-40X50	40	50	1/8"	M8 x 1,25	70.20
KKS-40X60	40	60	1/8"	M8 x 1,25	75.95
KKS-40X70	40	70	1/8"	M8 x 1,25	81.50
KKS-40X75	40	75	1/8"	M8 x 1,25	83.85
KKS-40X80	40	80	1/8"	M8 x 1,25	87.20
KKS-40X90	40	90	1/8"	M8 x 1,25	93.40

- KELMK™ pneumatiek
- Hydrauliek
- Snelkoppelingen
- Afsluiters
- Roestvast staal
- Fittingen
- Luchtconditionering
- Gereedschap
- Pneumatiek
- Diversen
- Malleabele fittingen & staal
- Ringleidingssystemen
- Slangen
- Compressoren

Compactcilinders

Werktemperatuur:
-20°C tot +80°C

Werkdruk:
1 tot 10 bar

Medium:

Geconditioneerde perslucht, gefilterd (40µm) en gesmeerd.

Met kunststof buffers

Behuizing: aluminium

Afdichtingen: NBR

Volledige technische specificaties worden op aanvraag verstrekt

Tech Data
3027

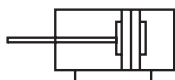

Magnetisch - dubbelwerkend

0334					€	0334					€
KKS-40X100	40	100	1/8"	M8 x 1,25	99.50	KKS-63X175	63	175	1/4"	M10 x 1,5	219.30
KKS-40X125	40	125	1/8"	M8 x 1,25	126.05	KKS-63X200	63	200	1/4"	M10 x 1,5	238.20
KKS-40X150	40	150	1/8"	M8 x 1,25	141.85	KKS-63X250	63	250	1/4"	M10 x 1,5	285.65
KKS-40X175	40	175	1/8"	M8 x 1,25	157.40	KKS-80X5	80	5	3/8"	M16 x 2	136.60
KKS-40X200	40	200	1/8"	M8 x 1,25	173.25	KKS-80X10	80	10	3/8"	M16 x 2	141.25
KKS-40X250	40	250	1/8"	M8 x 1,25	215.50	KKS-80X15	80	15	3/8"	M16 x 2	144.15
KKS-50X5	50	5	1/4"	M10 x 1,5	73.65	KKS-80X20	80	20	3/8"	M16 x 2	148.40
KKS-50X10	50	10	1/4"	M10 x 1,5	75.15	KKS-80X25	80	25	3/8"	M16 x 2	152.35
KKS-50X15	50	15	1/4"	M10 x 1,5	78.40	KKS-80X30	80	30	3/8"	M16 x 2	155.55
KKS-50X20	50	20	1/4"	M10 x 1,5	79.20	KKS-80X35	80	35	3/8"	M16 x 2	159.75
KKS-50X25	50	25	1/4"	M10 x 1,5	82.35	KKS-80X40	80	40	3/8"	M16 x 2	162.95
KKS-50X30	50	30	1/4"	M10 x 1,5	85.25	KKS-80X45	80	45	3/8"	M16 x 2	166.90
KKS-50X35	50	35	1/4"	M10 x 1,5	87.55	KKS-80X50	80	50	3/8"	M16 x 2	170.90
KKS-50X40	50	40	1/4"	M10 x 1,5	87.90	KKS-80X60	80	60	3/8"	M16 x 2	179.15
KKS-50X45	50	45	1/4"	M10 x 1,5	92.30	KKS-80X70	80	70	3/8"	M16 x 2	188.40
KKS-50X50	50	50	1/4"	M10 x 1,5	94.00	KKS-80X75	80	75	3/8"	M16 x 2	193.15
KKS-50X60	50	60	1/4"	M10 x 1,5	98.95	KKS-80X80	80	80	3/8"	M16 x 2	197.75
KKS-50X70	50	70	1/4"	M10 x 1,5	104.05	KKS-80X90	80	90	3/8"	M16 x 2	209.15
KKS-50X75	50	75	1/4"	M10 x 1,5	106.90	KKS-80X100	80	100	3/8"	M16 x 2	220.80
KKS-50X80	50	80	1/4"	M10 x 1,5	109.50	KKS-80X125	80	125	3/8"	M16 x 2	271.20
KKS-50X90	50	90	1/4"	M10 x 1,5	116.95	KKS-80X150	80	150	3/8"	M16 x 2	298.85
KKS-50X100	50	100	1/4"	M10 x 1,5	124.10	KKS-80X175	80	175	3/8"	M16 x 2	326.45
KKS-50X125	50	125	1/4"	M10 x 1,5	155.80	KKS-80X200	80	200	3/8"	M16 x 2	354.10
KKS-50X150	50	150	1/4"	M10 x 1,5	173.05	KKS-80X250	80	250	3/8"	M16 x 2	420.55
KKS-50X175	50	175	1/4"	M10 x 1,5	192.70	KKS-100X5	100	5	3/8"	M20 x 2,5	206.30
KKS-50X200	50	200	1/4"	M10 x 1,5	210.45	KKS-100X10	100	10	3/8"	M20 x 2,5	210.65
KKS-50X250	50	250	1/4"	M10 x 1,5	255.30	KKS-100X15	100	15	3/8"	M20 x 2,5	214.35
KKS-63X5	63	5	1/4"	M10 x 1,5	83.85	KKS-100X20	100	20	3/8"	M20 x 2,5	219.25
KKS-63X10	63	10	1/4"	M10 x 1,5	87.00	KKS-100X25	100	25	3/8"	M20 x 2,5	223.50
KKS-63X15	63	15	1/4"	M10 x 1,5	90.10	KKS-100X30	100	30	3/8"	M20 x 2,5	228.35
KKS-63X20	63	20	1/4"	M10 x 1,5	93.20	KKS-100X35	100	35	3/8"	M20 x 2,5	232.80
KKS-63X25	63	25	1/4"	M10 x 1,5	96.70	KKS-100X40	100	40	3/8"	M20 x 2,5	236.75
KKS-63X30	63	30	1/4"	M10 x 1,5	99.50	KKS-100X45	100	45	3/8"	M20 x 2,5	241.55
KKS-63X35	63	35	1/4"	M10 x 1,5	106.15	KKS-100X50	100	50	3/8"	M20 x 2,5	246.25
KKS-63X40	63	40	1/4"	M10 x 1,5	106.60	KKS-100X60	100	60	3/8"	M20 x 2,5	254.75
KKS-63X45	63	45	1/4"	M10 x 1,5	108.60	KKS-100X70	100	70	3/8"	M20 x 2,5	264.50
KKS-63X50	63	50	1/4"	M10 x 1,5	112.20	KKS-100X75	100	75	3/8"	M20 x 2,5	268.25
KKS-63X60	63	60	1/4"	M10 x 1,5	118.50	KKS-100X80	100	80	3/8"	M20 x 2,5	273.80
KKS-63X70	63	70	1/4"	M10 x 1,5	124.90	KKS-100X90	100	90	3/8"	M20 x 2,5	284.55
KKS-63X75	63	75	1/4"	M10 x 1,5	125.70	KKS-100X100	100	100	3/8"	M20 x 2,5	295.55
KKS-63X80	63	80	1/4"	M10 x 1,5	132.10	KKS-100X125	100	125	3/8"	M20 x 2,5	358.85
KKS-63X90	63	90	1/4"	M10 x 1,5	140.45	KKS-100X150	100	150	3/8"	M20 x 2,5	386.45
KKS-63X100	63	100	1/4"	M10 x 1,5	146.90	KKS-100X175	100	175	3/8"	M20 x 2,5	414.10
KKS-63X125	63	125	1/4"	M10 x 1,5	181.40	KKS-100X200	100	200	3/8"	M20 x 2,5	441.75
KKS-63X150	63	150	1/4"	M10 x 1,5	200.30	KKS-100X250	100	250	3/8"	M20 x 2,5	510.00

Compactcilinder bevestigingen

Tech Data
3028



Gaffelscharnier achter 'CB'

0334	Ø mm	€
KSS-12-CB	12	8.70
KSS-16-CB	16	8.95
KSS-20-CB	20	10.10
KSS-25-CB	25	11.20
KSS-32-CB	32	12.50
KSS-40-CB	40	13.85
KSS-50-CB	50	15.50
KSS-63-CB	63	17.60
KSS-80-CB	80	24.75
KSS-100-CB	100	25.25

Tech Data
3029



Flensbevestiging voor/achter 'FA/FB'

0334	Ø mm	€
KSS-12-FAFB	12	6.25
KSS-16-FAFB	16	6.35
KSS-20-FAFB	20	6.70
KSS-25-FAFB	25	7.60
KSS-32-FAFB	32	8.70
KSS-40-FAFB	40	9.30
KSS-50-FAFB	50	11.05
KSS-63-FAFB	63	14.25
KSS-80-FAFB	80	20.40
KSS-100-FAFB	100	25.20

Tech Data
3030



Bevestigingsvoet 'LB' (paar)

0334	Ø mm	To Suit Stroke	€
KSS-12-LB	12	Alle	5.20
KSS-16-LB	16	Alle	5.30
KSS-20-LB	20	>15	5.55
KSS-25-LB	25	>10	5.65
KSS-32-LB	32	>10	6.35
KSS-40-LB	40	Alle	6.60
KSS-50-LB	50	>15	7.30
KSS-63-LB	63	>10	10.10
KSS-80-LB	80	>20	11.15
KSS-100-LB	100	>15	12.65

Bevestigingsvoet 'LBS' (paar) - korte slaglengte

0334	Ø mm	To Suit Stroke	€
KSS-20-LBS-P1	20	<10	5.50
KSS-25-LBS-P1	25	<5	5.65
KSS-32-LBS-P1	32	<5	6.20
KSS-50-LBS-P1	50	<10	8.35
KSS-63-LBS-P1	63	<5	10.10
KSS-80-LBS-P1	80	<15	10.95
KSS-100-LBS-P1	100	<10	12.40

Compactcilinder magneetschakelaars

Tech Data
3031



Tweepolig - NO met LED - 2 meter

0334	Ø mm	€
KSS1-G	32-1005-240V AC/DC	14.75

Compactcilinder revisieset



Standaard

0334	Ø	€
KKSRK-12	12	3.25
KKSRK-16	16	3.40
KKSRK-20	20	4.20
KKSRK-25	25	4.50
KKSRK-32	32	4.75
KKSRK-40	40	6.15
KKSRK-50	50	7.35
KKSRK-63	63	8.95
KKSRK-80	80	13.75
KKSRK-100	100	16.40



Viton

0334	Ø	€
KKSRK-12-V	12	7.60
KKSRK-16-V	16	9.20
KKSRK-20-V	20	10.95
KKSRK-25-V	25	12.55
KKSRK-32-V	32	12.75
KKSRK-40-V	40	16.10
KKSRK-50-V	50	21.80
KKSRK-63-V	63	28.20
KKSRK-80-V	80	44.10
KKSRK-100-V	100	50.30

KELM™
pneumatiek

Hydrauliek

Snel-
koppelingen

Afsluiters

Roestvast
staal

Fittingen

Lucht-
conditionering

Gereedschap

Pneumatiek

Diversen

Malleabele
fittingen
& staal

Ringleiding-
systemen

Slangen

Compressoren

PNEUMATISCHE VENTIELEN

3/2 ventielen - mechanisch, elektrisch en luchtbediend

Stift met rol



K3M3L-06

Zie pagina 488

**Hefboom/
hefboom**



K3M3Y-06

Zie pagina 488

Paddestoelknop



K3M3PM-06-B

Zie pagina 489

Stift



KCB-06

Zie pagina 491

Handschuifventiel



KSV-06

Zie pagina 492

Pilot/veer



CKA210-06-NC

Zie pagina 493

4/2 en 5/2 ventielen - elektrisch, hand- en luchtbediend

**4/2 hefboom/
hefboom**



DKHV210-06-S

Zie pagina 491

**5/2 hefboom/
hefboom**



DKH210-06

Zie pagina 492

Voet/veer



DKF210-08

Zie pagina 492

Overige ventielen

Drukregelventiel



K100-06

Zie pagina 492

Wisselventiel



KP080214

Zie pagina 498

**Basisventiel
- YES**



KP080494

Zie pagina 498

**Schakelaar
- 2 posities**



K3M3HS06

Zie pagina 489

Trek/druk



CKL110-06

Zie pagina 490

**Paddestoelknop
- vergrendeling**



KSCPL-06-R

Zie pagina 490

**Direct
werkend**



KCV1-06-B

Zie pagina 489

Solenoid/veer



CKV210-06-NC

Zie pagina 495

**Verstelbare
rolnok/veer**



ZMCJ-06-W

Zie pagina 491

Pilot/pilot



DKA220-06

Zie pagina 493

Solenoid/veer



DKV220-06

Zie pagina 496

**Solenoid/veer
- NAMUR**



DKM310-08

Zie pagina 497

**Oscillatie
ventiel**

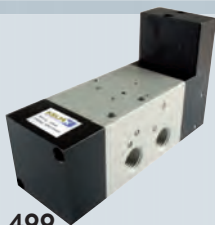

KP010444

Zie pagina 499

**High flow
pneumatische
timer**



KP000744

Zie pagina 500

2-hands veiligheidsunit



KP081564

Zie pagina 500



Werktemperatuur:
-20°C tot +70°C

Werkdruk:
0 tot 10 bar

Medium: Geconditioneerde perslucht. Gefilterd (40µm).
Materiaal: Aluminiumlegering
Afdichtingen: NBR
Volledige technische specificaties worden op aanvraag verstrekt

Tech Data
3097

Mechanisch bediende 3/2 ventielen - micro paneelmontage

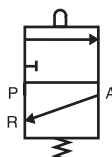

Stift

0335		€
K3M3B-05	M5	23.40
K3M3B-06	1/8"	23.40
K3M3B-08	1/4"	29.90

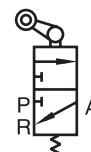

Stift met rol

0335		€
K3M3L-05	M5	34.00
K3M3L-06	1/8"	34.00
K3M3L-08	1/4"	40.70

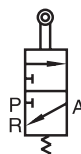

Rolarm

0335		€
K3M3R-05	M5	34.00
K3M3R-06	1/8"	34.00
K3M3R-08	1/4"	40.70



Hefboom/hefboom

0335		€
K3M3Y-05	M5	38.35
K3M3Y-06	1/8"	38.35
K3M3Y-08	1/4"	44.80



Rolarm - 1 richting

0335		€
K3M3V-05	M5	34.00
K3M3V-06	1/8"	34.00
K3M3V-08	1/4"	40.70



Werktemperatuur:
-20°C tot +70°C

Werkdruk:
0 tot 10 bar

Medium: Geconditioneerde perslucht. Gefilterd (40µm).
Materiaal: Aluminiumlegering
Afdichtingen: NBR
Volledige technische specificaties worden op aanvraag verstrekt

Tech Data
3097

Handbediende 3/2 ventielen - micro paneelmontage



Drukknop (omhuld)

0335



K3M3PF-05-B	M5	Zwart	38.35
K3M3PF-05-G	M5	Groen	38.35
K3M3PF-05-R	M5	Rood	38.35
K3M3PF-06-B	1/8"	Zwart	38.35
K3M3PF-06-G	1/8"	Groen	38.35
K3M3PF-06-R	1/8"	Rood	38.35
K3M3PF-08-B	1/4"	Zwart	44.80
K3M3PF-08-G	1/4"	Groen	44.80
K3M3PF-08-R	1/4"	Rood	44.80



Drukknop (extern)

0335



K3M3PP-05-B	M5	Zwart	38.35
K3M3PP-05-G	M5	Groen	38.35
K3M3PP-05-R	M5	Rood	38.35
K3M3PP-06-B	1/8"	Zwart	38.35
K3M3PP-06-G	1/8"	Groen	38.35
K3M3PP-06-R	1/8"	Rood	38.35
K3M3PP-08-B	1/4"	Zwart	44.80
K3M3PP-08-G	1/4"	Groen	44.80
K3M3PP-08-R	1/4"	Rood	44.80



Paddestoelknop

0335



K3M3PM-05-B	M5	Zwart	38.35
K3M3PM-05-G	M5	Groen	38.35
K3M3PM-05-R	M5	Rood	38.35
K3M3PM-06-B	1/8"	Zwart	38.35
K3M3PM-06-G	1/8"	Groen	38.35
K3M3PM-06-R	1/8"	Rood	38.35
K3M3PM-08-B	1/4"	Zwart	44.80
K3M3PM-08-G	1/4"	Groen	44.80
K3M3PM-08-R	1/4"	Rood	44.80

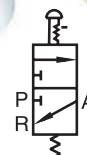

Paddestoelknop - vergrendeling

0335



K3M3PL-05-R	M5	Rood	38.35
K3M3PL-06-R	1/8"	Rood	38.35
K3M3PL-08-R	1/4"	Rood	44.80



Schakelaar - 2 posities

0335



K3M3HS05	M5	38.35
K3M3HS06	1/8"	38.35
K3M3HS08	1/4"	44.80

KELMTM
pneumatiek

Hydrauliek

Snel-
koppelingen

Afsluiters

Roestvast
staal

Fittingen

Lucht-
conditionering

Gereedschap

Pneumatiek

Diversen

Walleabele
fittings
& staal

Ringleiding-
systemen

Slangen

Compressoren



Werktemperatuur:
-20°C tot +70°C

Werkdruk:
0 tot 8 bar

Medium: Geconditioneerde perslucht, gefilterd (40µm) en gesmeerd.
Materiaal: Aluminiumlegering
Afdichtingen: NBR
Volledige technische specificaties worden op aanvraag verstrekt

Handbediende 3/2 ventielen

Tech Data
3032



Trek/druk

0335



CKL110-06	1/8"	23.25
CKL210-08	1/4"	26.30
CKL310-10	3/8"	35.70

Tech Data
3038



Drukknop (omhuld)

0335



KSCPF-06-B	1/8"	Zwart	22.00
KSCPF-06-G	1/8"	Groen	22.00
KSCPF-06-R	1/8"	Rood	22.00

Tech Data
3038



Drukknop (extern)

0335



KSCPP-06-B	1/8"	Zwart	22.00
KSCPP-06-G	1/8"	Groen	22.00
KSCPP-06-R	1/8"	Rood	22.00

Tech Data
3038



Paddestoelknop

0335



KSCPM-06-B	1/8"	Zwart	23.75
KSCPM-06-G	1/8"	Groen	23.75
KSCPM-06-R	1/8"	Rood	23.75

Tech Data
3038



Paddestoelknop - vergrendeling

0335



KSCPL-06-R	1/8"	Rood	23.65
------------	------	------	-------

Tech Data
3038



Hefboom/hefboom

0335



KSY-06	1/8"		23.65
--------	------	--	-------

Tech Data
3038



Schakelaar

0335



KSCHS-06-B	1/8"	Zwart	23.65
KSCHS-06-G	1/8"	Groen	23.65
KSCHS-06-R	1/8"	Rood	23.65



Werktemperatuur:
-20°C tot +70°C

Mechanisch bediende 3/2 ventielen

Tech Data
3038

Werkdruk:
0 tot 8 bar

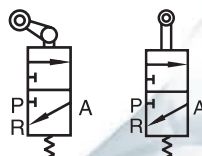

Rolnok

0335



KSCL-06	1/8"	Rolnok eenrichting hefboom	22.80
KSCR-06	1/8"	Rolnok hefboom	22.80
KSCV-06	1/8"	Rolnok	22.80

Tech Data
3038

Werkdruk:
0 tot 8 bar

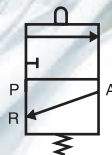

Stift

0335



KCB-06	1/8"		17.25
---------------	------	--	--------------

Tech Data
10061

Werkdruk:
0 tot 10 bar

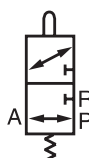

Rolnok/veer

0335



ZMCR-06-W	1/8"		75.25
------------------	------	--	--------------

Tech Data
10061

Werkdruk:
0 tot 10 bar

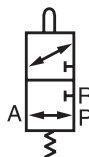

Verstelbare rolnok/veer

0335



ZMCJ-06-W	1/8"		78.35
------------------	------	--	--------------

Tech Data
10061

Werkdruk:
0 tot 10 bar



Antenne/veer

0335



ZMCP-06-W	1/8"		78.35
------------------	------	--	--------------

Handbediende 4/2 ventielen

Tech Data
3033

Werkdruk:
0 tot 10 bar

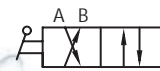

Hefboom/hefboom

0335



DKHV210-06-S	1/8"	34.55
DKHV310-08-S	1/4"	43.55
DKHV310-10-S	3/8"	43.55
DKHV410-15-S	1/2"	61.20
DKHV410-20-S	3/4"	62.10

Handbediende 4/3 ventielen

Tech Data
3033

Werkdruk:
0 tot 10 bar

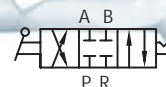

Hefboom/hefboom/hefboom - gesloten middenstand

0335



DKHV230-C-06-S	1/8"	34.55
DKHV330-C-08-S	1/4"	43.55
DKHV330-C-10-S	3/8"	43.55
DKHV430-C-15-S	1/2"	61.20
DKHV430-C-20-S	3/4"	62.10

KELMTM
pneumatiek

Hydrauliek

Snel-
koppelingen

Afsluiters

Roestvast
staal

Fittingen

Lucht-
conditionering

Gereedschap

Pneumatiek

Diversen

Malleabele
fittings
& staal

Ringleiding-
systemen

Slangen

Compressoren



Werktemperatuur:
-20°C tot +70°C

Werkdruk:
0 tot 8 bar

Handbediende 5/2 ventielen

Tech Data
3034



Trek/druk

0335



DKL110-06	1/8"	24.10
DKL210-08	1/4"	28.25
DKL310-10	3/8"	41.65

Tech Data
3041



Hefboom/hefboom

0335



DKH210-06	1/8"	31.35
DKH310-08	1/4"	45.10
DKH310-10	3/8"	45.10

Handbediende 5/3 ventielen

Tech Data
3045

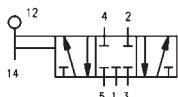

Hefboom/hefboom/hefboom - gesloten middenstand

0335



DKH230-C-06	1/8"	51.00
DKH230-C-08	1/4"	51.00
DKH330-C-10	3/8"	51.25

Tech Data
3046

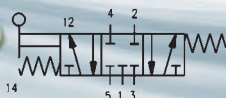

Hefboom/veer/hefboom - gesloten middenstand

0335



DKHA230-C-06	1/8"	59.95
DKHA230-C-08	1/4"	59.95
DKHA330-C-10	3/8"	61.20

Voetbediende 5/2 ventielen

Tech Data
3055

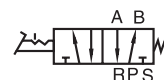

Voet/veer

0335



DKF210-08	-	48.65
DKF210-08G	Beschermd	57.90

Tech Data
3055

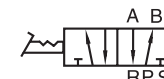
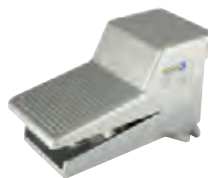

Voet/voet

0335



DKF210-08L	-	54.20
DKF210-08LG	Beschermd	64.75

Drukregelventielen

Tech Data
3056

Werkdruk:
0,5 tot 10 bar

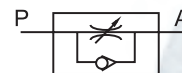

Eenrichting

0335



K100-06	1/8"	10.25
K200-08	1/4"	11.65
K300-10	3/8"	29.20
K300-15	1/2"	29.85

Handschuifventielen 3/2

Tech Data
3035

Werkdruk:
0-10 bar



BSP female

0335



KSV-06	1/8"	10.80
KSV-08	1/4"	11.60
KSV-10	3/8"	14.15
KSV-15	1/2"	24.55
KSV-20	3/4"	40.50
KSV-25	1"	60.40



Werktemperatuur:
-20°C tot +70°C

Werkdruk:
1,5 tot 8 bar

Medium: Geconditioneerde perslucht, gefilterd (40µm) en gesmeerd.
Materiaal: Aluminiumlegering Afdichtingen: NBR
Volledige technische specificaties worden op aanvraag verstrekt

Luchtbediende 3/2 ventielen

Tech Data
3036



Pilot/veer - NO

0335



CKA210-06-NO	1/8"	32.60
CKA210-08-NO	1/4"	35.85
CKA310-10-NO	3/8"	62.60

Tech Data
3036



Pilot/veer - NC

0335



CKA210-06-NC	1/8"	32.60
CKA210-08-NC	1/4"	35.85
CKA310-10-NC	3/8"	62.60

Tech Data
3036

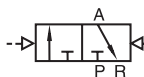

Pilot/pilot

0335



CKA220-06	1/8"	43.65
CKA220-08	1/4"	48.00
CKA320-10	3/8"	75.55

Luchtbediende 5/2 ventielen

Tech Data
3037



Pilot/veer

0335



DKA210-06	1/8"	42.65
DKA210-08	1/4"	42.65
DKA310-10	3/8"	47.65
DKA410-15	1/2"	65.00

Tech Data
3037



Pilot/pilot

0335



DKA220-06	1/8"	46.95
DKA220-08	1/4"	46.95
DKA320-10	3/8"	55.15
DKA420-15	1/2"	74.30

KELMK™
pneumatiek

Hydrauliek

Snel-
koppelingen

Afsluiters

Roestvast
staal

Fittingen

Lucht-
conditionering

Gereedschap

Pneumatiek

Diversen

Malleabele
fittingen
& staal

Ringleiding-
systemen

Slangen

Compressoren



Werktemperatuur:
-20°C tot +70°C

Werkdruk:
1,5 tot 8 bar

Medium: Geconditioneerde perslucht, gefilterd (40µm) en gesmeerd.
Materiaal: Aluminiumlegering Afdichtingen: NBR
Volledige technische specificaties worden op aanvraag verstrekt

Tech Data
3037

Luchtbediende 5/3 ventielen

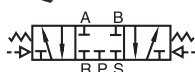

Pilot/pilot - gesloten middenstand

0335	BSPP	€
DKA230C-06	1/8"	68.20
DKA230C-08	1/4"	75.00
DKA330C-10	3/8"	82.50
DKA430C-15	1/2"	98.85



Pilot/pilot - middenstand druk

0335	BSPP	€
DKA230P-06	1/8"	68.20
DKA230P-08	1/4"	75.00
DKA330P-10	3/8"	82.50
DKA430P-15	1/2"	98.85



Pilot/pilot - middenstand ontvlucht

0335	BSPP	€
DKA230E-06	1/8"	68.20
DKA230E-08	1/4"	75.00
DKA330E-10	3/8"	82.50
DKA430E-15	1/2"	98.85



Werktemperatuur:
-20°C tot +70°C

Werkdruk:
1,5 tot 8 bar

Medium: Schone perslucht. Gefilterd (40µm) & gesmeerd.
Materiaal: Aluminiumlegering Afdichtingen: NBR
Volledige technische specificaties worden op aanvraag verstrekt

Elektrisch bediende 3/2 ventielen

Tech Data
3107



Direct werkend - NO - M5

0335



KCV1-M5-B	24V DC	36.35
KCV1-M5-C	110V 50/60Hz	36.35
KCV1-M5-A	220V 50/60Hz	36.35

Tech Data
3107



Direct werkend - NC - 1/8"

0335



KCV1-06-B	24V DC	36.35
KCV1-06-C	110V 50/60Hz	36.35
KCV1-06-A	220V 50/60Hz	36.35

Tech Data
3039



Solenoid/veer - NO

0335



CKV210-06-NO	1/8"	29.30
CKV210-08-NO	1/4"	32.30
CKV310-10-NO	3/8"	47.65

Tech Data
3039



Solenoid/veer - NC

0335



CKV210-06-NC	1/8"	30.85
CKV210-08-NC	1/4"	33.90
CKV310-10-NC	3/8"	48.25

Tech Data
3039



Solenoid/solenoid

0335



CKV220-06	1/8"	49.20
CKV220-08	1/4"	54.15
CKV320-10	3/8"	75.45

Bevestigingscomponenten

Tech Data
3107



Koppelingsschroef en O-ring

0335



KCV1-P31	1.90
----------	------

Tech Data
3107



Koppelingsschroef en (eind)bevestigingsmoer

0335



KCV1-P30	2.20
----------	------

Tech Data
3107



Basisplaat

0335



KCV1-P32	2.20
----------	------

KELM™
pneumatiek

Hydrauliek

Snel-
koppelingen

Afsluiters

Roestvast
staal

Fittingen

Lucht-
conditionering

Gereedschap

Pneumatiek

Diversen

Malleabele
fittingen
& staal

Ringleiding-
systemen

Slangen

Compressoren



Werktemperatuur:
-20°C tot +70°C

Werkdruk:
1,5 tot 8 bar

Medium: Schone perslucht. Gefilterd (40µm) & gesmeerd.
Materiaal: Aluminiumlegering Afdichtingen: NBR
Volledige technische specificaties worden op aanvraag verstrekt

Tech Data
3040

Elektrisch bediende 5/2 ventielen



Solenoid/veer

0335	BSPP	€
DKV210-06	1/8"	30.85
DKV210-08	1/4"	33.90
DKV310-10	3/8"	47.45
DKV410-15	1/2"	64.75



Solenoid/solenoid

0335	BSPP	€
DKV220-06	1/8"	47.95
DKV220-08	1/4"	50.55
DKV320-10	3/8"	75.45
DKV420-15	1/2"	92.95

Elektrisch bediende 5/3 ventielen

Alleen te gebruiken bij 5/2 ventielen



Solenoid/solenoid - gesloten middenstand

0335	BSPP	€
DKV230C-06	1/8"	67.45
DKV230C-08	1/4"	70.30
DKV330C-10	3/8"	106.80
DKV430C-15	1/2"	122.55



Solenoid/solenoid - middenstand ontlucht

0335	BSPP	€
DKV230E-06	1/8"	67.45
DKV230E-08	1/4"	67.45
DKV330E-10	3/8"	101.45
DKV430E-15	1/2"	122.00



Solenoid/solenoid - middenstand druk

0335	BSPP	€
DKV230P-06	1/8"	68.60
DKV230P-08	1/4"	75.50
DKV330P-10	3/8"	101.45
DKV430P-15	1/2"	120.75



Basisplaten

Tech Data
3042



1/4" BSP

0335	No. of Stations	€
BOOKM-2F	2	10.80
BOOKM-3F	3	16.20
BOOKM-4F	4	21.00
BOOKM-5F	5	25.95
BOOKM-6F	6	31.60
BOOKM-1F	1	10.30
BOOKM-8F	8	42.10
BOOKM-10F	10	51.80

3/8" BSP

0335	No. of Stations	€
COOKM-4F	4	29.70
COOKM-1F	1	12.65
COOKM-2F	2	14.65
COOKM-3F	3	22.25
COOKM-5F	5	37.20
COOKM-6F	6	44.65
COOKM-8F	8	59.45
COOKM-10F	10	74.30

Het maximaal beschikbare aantal stations is 8

1/2" BSP

0335	No. of Stations	€
DOOKM-4F	4	57.50
DOOKM-5F	5	71.90
DOOKM-6F	6	86.25
DOOKM-8F	8	117.75
DOOKM-2F	2	28.80
DOOKM-3F	3	42.40
DOOKM-1F	1	23.70

Blindplaten

Tech Data
3042

0335	To Suit	€
A00KM-B	A-serie	0.95
B00KM-B	B-serie	0.65
C00KM-B	C-serie	1.45
D00KM-B	D-serie	3.65

Namur 5/2 ventielen

Tech Data
3043

Solenoid/veer

0335	BSPP	€
DKM310-08	1/4"	58.50
DKM310-10	3/8"	64.40

Tech Data
3043

Solenoid/solenoid

0335	BSPP	€
DKM320-08	1/4"	89.05
DKM320-10	3/8"	98.00

Spoelen met stekker

Tech Data
3044

Spoel en LED-connector

0335	€
K-12DC	12V DC 20.20
K-24DC	24V DC 17.55
K-24AC	24V 50/60Hz 17.55
K-110AC	110V 50/60Hz 17.55
K-220AC	220V 50/60Hz 17.55

KELM™ pneumatiek

Hydrauliek

Snelkoppelingen

Afsluiters

Roestvast staal

Fittingen

Luchtconditionering

Gereedschap

Pneumatiek

Diversen

Malleabele fittingen & staal

Ringleidingssystemen

Slangen

Compressoren



Werktemperatuur:
0°C tot +60°C

Werkdruk:
2 tot 10 bar

Tech Data
3098

Basisventiel - NOT

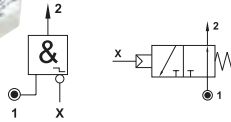

4mm push-in

0335

KP080394



29.75

Basisventiel - YES

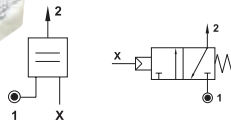

4mm push-in

0335

KP080494



29.75

Wisselventiel - OR

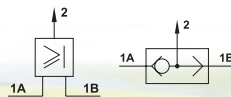

4mm push-in

0335

KP080214



20.30

Twedrukventiel - AND

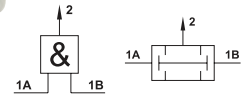

4mm push-in

0335

KP080254



20.30

Monostabiel ventiel

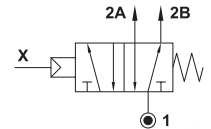

4mm push-in

0335

KP040034



52.55



Werktemperatuur:
0°C tot +60°C

Impuls ventielen

Tech Data
3099

Werkdruk:
2 tot 10 bar



1/8" BSP - NO

0335

KP100014



50.40

Tech Data
3099

Werkdruk:
2 tot 10 bar



1/8" BSP - NC

0335

KP100094



50.40

Oscillatie ventielen

Tech Data
3100

Werkdruk:
2 tot 10 bar



1/4" BSP - continue cyclus

0335

KP010444



151.35

Tech Data
3100

Werkdruk:
2 tot 10 bar



1/4" BSP - luchtbediend

0335

KP010464



161.65

Flip Flop ventiel

Tech Data
3103

Werkdruk:
3 tot 10 bar



1/4" BSP - luchtbediend

0335

KP100354



171.85

KELM™
pneumatiek

Hydrauliek

Snel-
koppelingen

Afsluiters

Roestvast
staal

Fittingen

Lucht-
conditionering

Gereedschap

Pneumatiek

Diversen

Malleabele
fittingen
& staal

Ringleiding-
systemen

Slangen

Compressoren



Werktemperatuur:
0°C tot +60°C

High flow pneumatische timer

Tech Data
3101

Werkdruk:
2 tot 10 bar



Voor automatische teruggang - 1/8" BSP

0335

KP000744



113.15

Vacuümgedreven vloeistofspoeier

Tech Data
3102

Werkdruk:
3 tot 8 bar



M5

0335

KP2005



29.75

Veiligheidsunit (voor 2-handsgebruik)

Tech Data
3099



Werktemperatuur:
0°C tot +60°C

Werkdruk:
3 tot 8 bar

4mm push-in

0341

KP081564



433.90

Basis veiligheidsunit - 1/8" BSP

0341

KPB081564



169.10

KELMKTM
Enhanced Quality Performance

Deze geassembleerde unit is speciaal ontworpen met de veiligheid van operators in gedachten.

De unit vereist beide handen van de operator om te functioneren. Als beide 3/2 drukknop ventielen niet geactiveerd zijn binnen 0.5 seconden zal de unit niet in werking worden gesteld.



Pneumatische kogelvibratoren

Tech Data
1012



Max. omgevings-
temperatuur
+100°C



Werkdruk
Minimaal 2 bar
Maximaal 6 bar

- Deze pneumatische kogelvibrator veroorzaakt door middel van een roterende kogel een roterende trilling. De frequentie kan geregeld worden door aanpassing van de persluchtdruk
- Toepassing: Het in beweging houden, verdichten en lostrillen van stortgoed. Voorbeelden: Chemische poeders, graan, zand, grind en cement.
- Voor binnen- en buitengebruik, maar niet bestand tegen onderdompeling in vloeistof.

BSP female

0314				Air Consumption at 6 bar	V.P.M. 6 bar	€
JM8	1/4"	2	6	195 liter	35100	90.80
JM10	1/4"	2	6	200 liter	34100	95.30
JM13	1/4"	2	6	225 liter	22510	131.65
JM16	1/4"	2	6	280 liter	19510	163.40
JM20	1/4"	2	6	340 liter	16510	195.90
JM25	1/4"	2	6	425 liter	14100	217.70
JM30	3/8"	2	6	570 liter	12510	283.00
JM36	3/8"	2	6	675 liter	10100	313.50

Pneumatische turbinevibratoren

Tech Data
1013



Max. omgevings-
temperatuur
+120°C



Werkdruk
Minimaal 2 bar
Maximaal 6 bar

- Deze pneumatische turbinevibrator veroorzaakt door middel van een excentrisch roterende rotor een roterende trilling. De frequentie kan geregeld worden door aanpassing van de persluchtdruk.
- Toepassing: Het in beweging houden, verdichten en lostrillen van stortgoed in o.a. silo's. Voorbeelden: Chemische poeders, graan, zand, grind en cement.

BSP female

0314				Air Consumption at 6 bar	V.P.M. 6 bar	€
JMT8	1/4"	2	6	120 liter	45900	130.60
JMT10	1/4"	2	6	120 liter	37600	145.35
JMT13	1/4"	2	6	290 liter	39800	174.15
JMT16	1/4"	2	6	290 liter	24100	182.85
JMT20	1/4"	2	6	455 liter	23100	244.35
JMT25	3/8"	2	6	455 liter	17100	272.45
JMT30	3/8"	2	6	745 liter	16100	492.20
JMT36	3/8"	2	6	745 liter	13000	553.70

- **Mais**
- **Cement**
- **Chemische poeders**
- **Zand**
- **Grind**

Pneumatische zuigervibratoren

Tech Data
10158

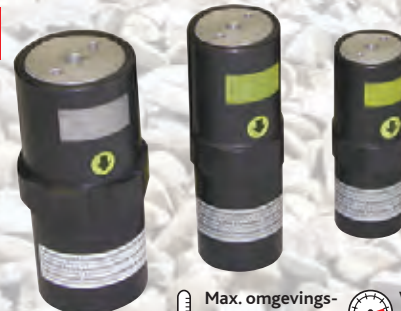

Max. omgevings-
temperatuur
+100°C



Werkdruk
Minimaal 2 bar
Maximaal 6 bar

Aluminium - BSP female

0314				Air Consumption at 6 bar	€
KFP-18-M	1/8"	2	6	55 liter	265.40
KFP-25-M	1/4"	2	6	88 liter	265.40
KFP-35-M	1/4"	2	6	145 liter	353.95

Flowregelaars met geïntegreerde functie

Geschikt voor perslucht, overdruk en vacuüm.

Toepassing: Flowregelaars worden op cilinders of ventielen gebouwd om de snelheid van de slag van de cilinder (uitgaand, ingaand of beide) goed in te regelen. Flowregelaars worden als smoorregeling toegepast. Het beste resultaat wordt verkregen door de uitgaande luchtstroom te smoren, waardoor schokkend werken van de cilinder wordt voorkomen.

Temperatuur:
-20°C tot 80°C

Maximale werkdruk:
1 tot 10 bar *

*** Attentie:** De drukgegevens zijn gebaseerd op een temperatuur van 20°C. Veiligheidsfactor = 3. Bij temperatuurverhoging daalt de werkdruk met een variabele factor, zie tabel PA. Voor correcte werking is minimaal een druk nodig van 1 Bar

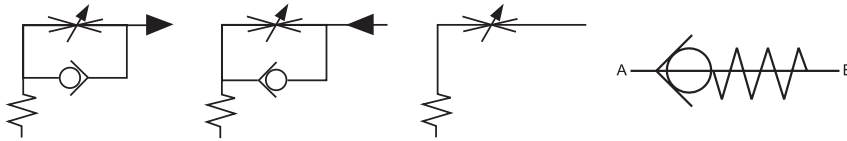

Flowregelaar - afvoer

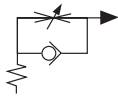

Enriching - verzonken regelschroef

MRK				€
90090500	M5	8	24	8.75
90091000	1/8"	14	30.5	6.45
90091300	1/4"	17	36	7.05

Flowregelaar - toevoer

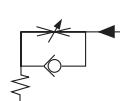

Enriching - verzonken regelschroef

MRK				€
90110500	M5	8	24	8.75
90111000	1/8"	14	30.5	6.45
90111300	1/4"	17	35.5	7.05

Flowregelaar - bidirectioneel

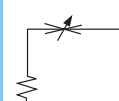

Tweerichting - verzonken regelschroef

MRK				€
90120500	M5	8	24	6.55
90121000	1/8"	14	30.5	4.80
90121300	1/4"	17	35.5	5.45

KELM™ pneumatiek

Hydrauliek

Snelkoppelingen

Afsluiters

Roestvast staal

Fittingen

Luchtconditionering

Gereedschap

Pneumatiek

Diversen

Malleabele fittingen & staal

Ringleidingssystemen

Slangen

Compressoren

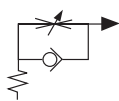

Enriching - uitwendige regelschroef

MRK				€
90350500	M5	8	35	9.80
90351000	1/8"	14	45	7.05
90351300	1/4"	17	51.5	7.95

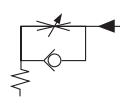

Enriching - uitwendige regelschroef

MRK				€
90360500	M5	8	35	9.80
90361000	1/8"	14	45	7.05
90361300	1/4"	17	51.5	8.10

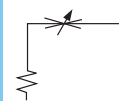

Tweerichting - uitwendige regelschroef

MRK				€
90370500	M5	8	35	7.20
90371000	1/8"	14	45	5.80
90371300	1/4"	17	51.5	6.15

Flowregelaar - terugslagklep



Niet instelbaar - stroomrichting van bout naar huis

MRK				€
90381000	1/8"	14	32.5	10.45
90381300	1/4"	17	35	10.85



Niet instelbaar - stroomrichting van huis naar bout

MRK				€
90391000	1/8"	14	32.5	10.45
90391300	1/4"	17	35	11.45

Flowregelaar opsteek - afvoer

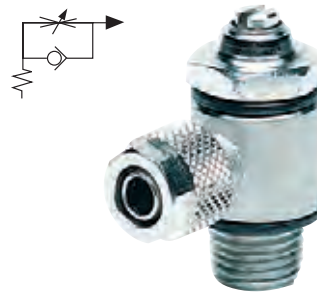

Enriching - verzonken regelschroef

MRK				€
90020405	4 x M5	8	24	11.00
90020410	4 x 1/8"	14	30.5	8.90
90020605	6 x M5	8	26	10.85
90020610	6 x 1/8"	14	31	9.05
90020613	6 x 1/4"	17	36	9.80
90020810	8 x 1/8"	14	31	9.05
90020813	8 x 1/4"	17	36	9.90
90021013	10 x 1/4"	17	36	9.65



Enriching - uitwendige regelschroef

MRK				€
91020405	4 x M5	8	35	11.45
91020410	4 x 1/8"	14	45	9.20
91020605	6 x M5	8	35	11.45
91020610	6 x 1/8"	14	45	9.30
91020613	6 x 1/4"	17	52	10.30
91020810	8 x 1/8"	14	45	9.30
91020813	8 x 1/4"	17	52	10.40
91021013	10 x 1/4"	17	52	10.50

Flowregelaar opsteek (POM) - afvoer

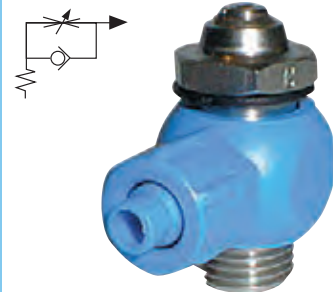

Enriching - verzonken regelschroef

MRK				€
90040610	6 x 1/8"	14	31	7.65
90040613	6 x 1/4"	17	36	8.35
90040810	8 x 1/8"	14	31	7.65
90040813	8 x 1/4"	17	36	8.40

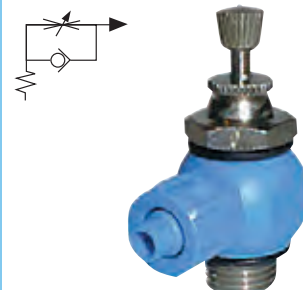

Enriching - uitwendige regelschroef

MRK				€
91040610	6 x 1/8"	14	45	8.20
91040613	6 x 1/4"	17	52	9.30
91040810	8 x 1/8"	14	45	8.20
91040813	8 x 1/4"	17	52	9.30

Voor
 AIGNEP
 opsteekkoppelingen
 zie hoofdstuk 6



KELM™
pneumatiek

Hydrauliek

Snelkoppelingen

Afsluiters

Roestvast
staal

Fittingen

Lucht-
conditionering

Gereedschap

Pneumatiek

Diversen

Malleabele
fittingen
& staal

Ringleiding-
systemen

Slangen

Compressoren

FLOWREGELAARS



Flowregelaar push-in - afvoer

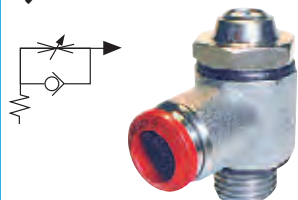

Eenrichting - verzonken regelschroef

MRK				€
90090405	4 x M5	8	24	11.45
90090410	4 x 1/8"	14	31	9.20
90090610	6 x 1/8"	14	31	9.30
90090613	6 x 1/4"	17	36	10.20
90090810	8 x 1/8"	14	31	9.65
90090813	8 x 1/4"	17	36	10.40
90091013	10 x 1/4"	17	36	10.75

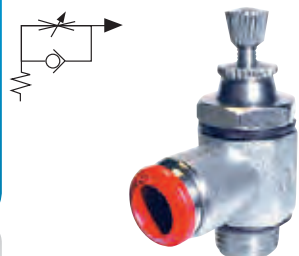

Eenrichting - uitwendige regelschroef

MRK				€
91090405	4 x M5	8	35	12.65
91090410	4 x 1/8"	14	45	9.85
91090610	6 x 1/8"	14	45	9.95
91090613	6 x 1/4"	17	52	11.10
91090810	8 x 1/8"	14	45	10.30
91090813	8 x 1/4"	17	52	11.25
91091013	10 x 1/4"	17	52	11.70

Compacte flowregelaar push-in - afvoer

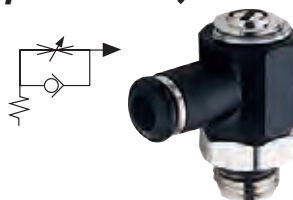

Eenrichting - verzonken regelschroef - kort conisch draad met seal

MRK				€
90160405	4 x M5	8	24	13.20
90160410	4 x 1/8"	14	30.5	10.60
90160605	6 x M5	8	24	13.25
90160610	6 x 1/8"	14	30.5	10.60
90160613	6 x 1/4"	17	36	11.45
90160810	8 x 1/8"	14	30.5	10.60
90160813	8 x 1/4"	17	36	11.45

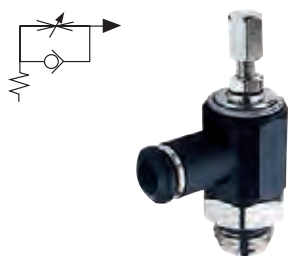

Eenrichting - uitwendige regelschroef - kort conisch draad met seal

MRK				€
90170405	4 x M5	8	37.5	13.50
90170410	4 x 1/8"	14	46.5	10.75
90170605	6 x M5	8	37.5	13.50
90170610	6 x 1/8"	14	46.5	10.75
90170613	6 x 1/4"	17	53	11.70
90170810	8 x 1/8"	14	46.5	10.75
90170813	8 x 1/4"	17	53	11.70

Flowregelaar push-in - afvoer



Eenrichting - uitwendige regelschroef en borgmoer

INLB		€
33310405N	4 x M5	6.70
33310413N	4 x 1/4"	8.00
33310410N	4 x 1/8"	8.15
33310605N	6 x M5	7.20
33310610N	6 x 1/8"	8.25
33310613N	6 x 1/4"	8.50
33310617N	6 x 3/8"	10.65
33310810N	8 x 1/8"	8.70
33310813N	8 x 1/4"	8.90
33310817N	8 x 3/8"	10.65
33311013N	10 x 1/4"	11.05
33311017N	10 x 3/8"	11.05
33311021N	10 x 1/2"	15.90
33311213N	12 x 1/4"	14.80
33311217N	12 x 3/8"	16.00
33311221N	12 x 1/2"	16.10

Inline flowregelaar push-in - afvoer

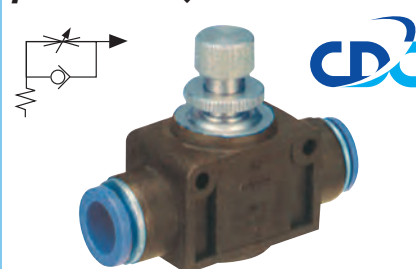

Eenrichting - uitwendige regelschroef en borgmoer

INLB		€
33300400N	4	8.90
33300600N	6	10.30
33300800N	8	11.85
33301000N	10	13.20
33301200N	12	14.85

Flowregelaar BSP female - afvoer

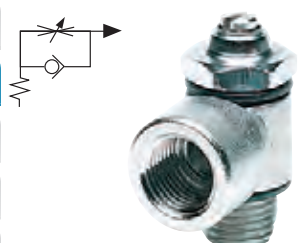

Eenrichting - verzonken regelschroef

MRK				€
90111010	1/8"	14	31	8.40
90111313	1/4"	17	36	9.30

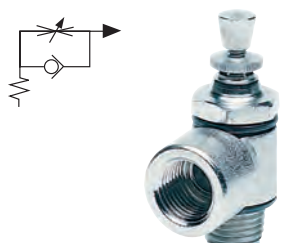

Eenrichting - uitwendige regelschroef

MRK				€
91111010	1/8"	14	35	9.00
91111313	1/4"	17	45	10.30

Flowregelaar opsteek - toevoer

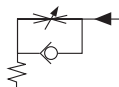

Enriching - verzonken regelschroef

MRK			H mm	€
90010405	4 x M5	8	24	10.40
90010410	4 x 1/8"	14	30.5	8.50
90010605	6 x M5	8	26	10.40
90010610	6 x 1/8"	14	31	8.70
90010613	6 x 1/4"	17	36	9.30
90010810	8 x 1/8"	14	31	8.70
90010813	8 x 1/4"	17	36	9.55
90011013	10 x 1/4"	17	36	9.65

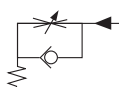

Enriching - uitwendige regelschroef

MRK			H mm	€
91010405	4 x M5	8	35	11.45
91010410	4 x 1/8"	14	45	9.20
91010605	6 x M5	8	35	11.65
91010610	6 x 1/8"	14	45	9.30
91010613	6 x 1/4"	17	52	10.50
91010810	8 x 1/8"	14	45	9.30
91010813	8 x 1/4"	17	52	10.50
91011013	10 x 1/4"	17	52	10.75

Flowregelaar opsteek (POM) - toevoer

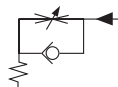

Enriching - verzonken regelschroef

MRK			H mm	€
90030610	6 x 1/8"	14	31	7.65
90030613	6 x 1/4"	17	36	8.35
90030810	8 x 1/8"	14	31	7.65
90030813	8 x 1/4"	17	36	8.35

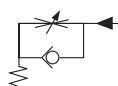

Enriching - uitwendige regelschroef

MRK			H mm	€
91030610	6 x 1/8"	14	45	8.20
91030613	6 x 1/4"	17	52	9.55
91030810	8 x 1/8"	14	45	8.20
91030813	8 x 1/4"	17	52	9.55

Flowregelaar push-in - toevoer

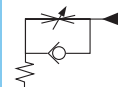

Enriching - verzonken regelschroef

MRK			H mm	€
90070405	4 x M5	8	24	11.45
90070410	4 x 1/8"	14	31	9.20
90070610	6 x 1/8"	14	31	9.30
90070613	6 x 1/4"	17	36	10.20
90070810	8 x 1/8"	14	31	9.65
90070813	8 x 1/4"	17	36	10.40
90071013	10 x 1/4"	17	36	10.75

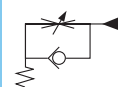

Enriching - uitwendige regelschroef

MRK			H mm	€
91070405	4 x M5	8	35	12.65
91070410	4 x 1/8"	14	45	9.85
91070610	6 x 1/8"	14	45	9.95
91070613	6 x 1/4"	17	52	11.15
91070810	8 x 1/8"	14	45	10.30
91070813	8 x 1/4"	17	52	11.45
91071013	10 x 1/4"	17	52	11.80

KELM™
pneumatiek

Hydrauliek

Snel-
koppelingen

Afsluiters

Roestvast
staal

Fittingen

Lucht-
conditionering

Gereedschap

Pneumatiek

Diversen

Malleabele
fittingen
& staal

Ringleiding-
systemen

Slangen

Compressoren

Compacte flowregelaar push-in - toevoer

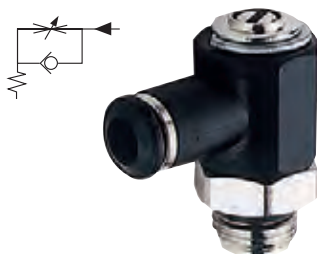

Eenrichting - verzonken regelschroef - kort conisch draad met seal

MRK			H mm	€
90180405	4 x M5	8	24	13.20
90180410	4 x 1/8"	14	30.5	10.60
90180605	6 x M5	8	24	13.20
90180610	6 x 1/8"	14	30.5	10.60
90180613	6 x 1/4"	17	36	11.45
90180810	8 x 1/8"	14	30.5	10.60
90180813	8 x 1/4"	17	36	11.35

Flowregelaar BSP female - toevoer

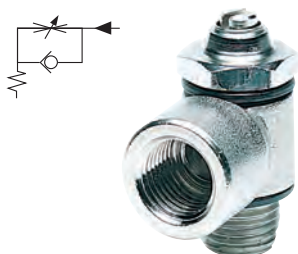

Eenrichting - verzonken regelschroef

MRK	BSPF		H mm	€
90101010	1/8"	14	31	8.40
90101313	1/4"	17	36	9.30

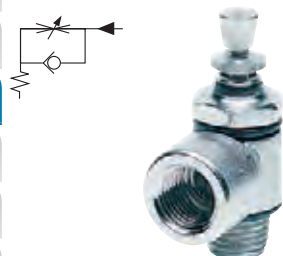

Eenrichting - uitwendige regelschroef

MRK	BSPF		H mm	€
91101010	1/8"	14	35	9.00
91101313	1/4"	17	45	10.50

Flowregelaar opsteek - bidirectioneel



Tweerichting - verzonken regelschroef

MRK			H mm	€
90120405	4 x M5	8	24	8.10
90120410	4 x 1/8"	14	31	6.80
90120605	6 x M5	8	26	8.15
90120610	6 x 1/8"	14	31	6.90
90120613	6 x 1/4"	17	36	7.65
90120810	8 x 1/8"	14	31	6.95
90120813	8 x 1/4"	17	36	7.80
90121013	10 x 1/4"	17	36	7.90

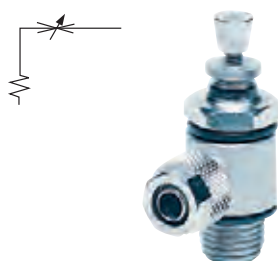

Tweerichting - uitwendige regelschroef

MRK			H mm	€
91120405	4 x M5	8	35	8.85
91120410	4 x 1/8"	14	45	7.80
91120605	6 x M5	8	43	8.85
91120610	6 x 1/8"	14	45	7.90
91120613	6 x 1/4"	17	52	8.40
91120810	8 x 1/8"	14	45	8.00
91120813	8 x 1/4"	17	52	8.50
91121013	10 x 1/4"	17	52	8.70

Flowregelaar push-in - bidirectioneel

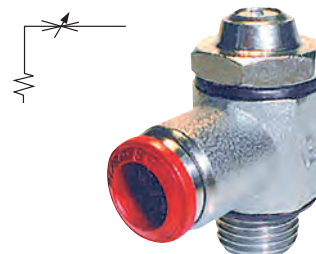

Tweerichting - verzonken regelschroef

MRK			H mm	€
90130405	4 x M5	8	24	9.20
90130410	4 x 1/8"	14	31	7.45
90130610	6 x 1/8"	14	31	7.65
90130613	6 x 1/4"	17	36	8.40
90130810	8 x 1/8"	14	31	7.90
90130813	8 x 1/4"	17	36	8.70
90131013	10 x 1/4"	17	36	9.00



Tweerichting - uitwendige regelschroef

MRK			H mm	€
91130405	4 x M5	8	35	9.85
91130410	4 x 1/8"	14	45	8.40
91130610	6 x 1/8"	14	45	8.50
91130613	6 x 1/4"	17	52	9.20
91130810	8 x 1/8"	14	45	8.85
91130813	8 x 1/4"	17	52	9.55
91131013	10 x 1/4"	17	52	9.85

Voor push-in koppelingen zie hoofdstuk 6



Flowregelaar BSP female - bidirectioneel



Tweerichting - verzonken regelschroef

MRK	BSPP	C	H mm	€
90141010	1/8"	14	31	6.55
90141313	1/4"	17	36	7.65



Tweerichting - uitwendige regelschroef

MRK	BSPP	C	H mm	€
91141010	1/8"	14	35	8.70
91141313	1/4"	17	45	9.80

Compacte flowregelaar push-in - bidirectioneel



Tweerichting - verzonken regelschroef - kort conisch draad met seal

MRK	C	H mm	€	
90200405	4 x M5	8	24	13.20
90200410	4 x 1/8"	14	30.5	10.60
90200605	6 x M5	8	24	13.20
90200610	6 x 1/8"	14	30.5	10.60
90200613	6 x 1/4"	17	36	11.45
90200810	8 x 1/8"	14	30.5	10.60
90200813	8 x 1/4"	17	36	11.45

Inline flowregelaar BSP female

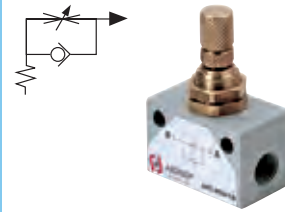

Enriching - uitwendige regelschroef

MRK	C	H mm	€	
90050505	M5	12	26	9.70
90051010	1/8"	15	35	9.20
90051313	1/4"	15	46	12.40
90051717	3/8"	22	50	23.60
90052121	1/2"	22	60	25.70



Tweerichting - uitwendige regelschroef

MRK	C	H mm	€	
90060505	M5	12	26	9.70
90061010	1/8"	15	35	9.20
90061313	1/4"	15	46	12.40
90061717	3/8"	22	50	23.60
90062121	1/2"	22	60	25.70

LOGICVENTIELEN

Temperatuur: -10°C tot +60°C

Maximale werkdruk: 2 tot 10 bar

Huis: geanodiseerd aluminium
 Veren: RVS
 Seals: NBR
 Inerne delen: messing

Medium: Perslucht

Wisselventiel (OF-ventiel)

NEW



BSP female

6690	BSPP	ND mm	€
8870-1/8	1/8"	2.5	24.20

Tweedrukventiel (EN-ventiel)

NEW



BSP female

6690	BSPP	ND mm	€
8872-1/8	1/8"	2.5	24.65

KELM™ pneumatiek

Hydrauliek

Snelkoppelingen

Afsluiters

Roestvast staal

Fittingen

Luchtconditionering

Gereedschap

Pneumatiek

Diversen

Malleabele fittingen & staal

Ringleidingssystemen

Slangen

Compressoren



Temperatuur:
-10°C tot +60°C



Maximale werkdruk:
Monostabiel: 2 tot 10 bar
Bistabiel: 1 tot 10 bar



FLOW
1/8": 740 NL/min
1/4": 1200 NL/min



Huis: geanodiseerd aluminium
Spoel: chemisch vernikkeld
Seals: NBR

Elektropneumatische ventielen worden standaard geleverd zonder spoel en stekker. Deze zijn te vinden op pagina 513

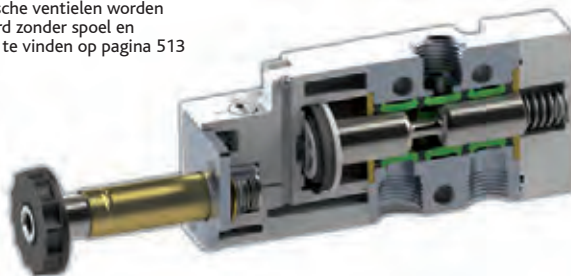

Elektropneumatische 3/2 ventielen

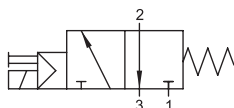

NC - monostabiel veer retour

6690	BSPP	€
01VS03NC02	1/8"	67.60
01VS03NC03	1/4"	73.50

Elektropneumatische 5/2 ventielen

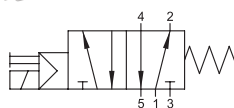
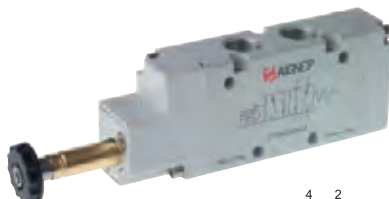

Monostabiel veer retour

6690	BSPP	€
01VS050002	1/8"	72.85
01VS050003	1/4"	78.00

Elektropneumatische 5/3 ventielen

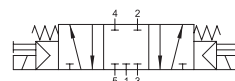

Monostabiel veer retour - CC
middenstand gesloten

6690	BSPP	€
01VS07CC02	1/8"	119.40
01VS07CC03	1/4"	135.05

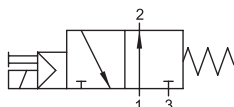

NO - monostabiel veer retour

6690	BSPP	€
01VS03NO02	1/8"	67.60
01VS03NO03	1/4"	73.50

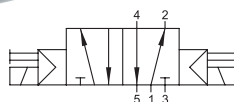

Bistabiel

6690	BSPP	€
01VS150002	1/8"	93.45
01VS150003	1/4"	102.65



Monostabiel veer retour - OC
middenstand geopend

6690	BSPP	€
01VS07OC02	1/8"	119.40
01VS07OC03	1/4"	135.05

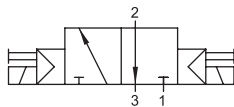

Bistabiel

6690	BSPP	€
01VS130002	1/8"	89.85
01VS130003	1/4"	96.05

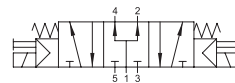

Monostabiel veer retour - PC
middenstand onder druk

6690	BSPP	€
01VS07PC02	1/8"	119.40
01VS07PC03	1/4"	135.05

KELM™ pneumatiek

Hydrauliek

Snelkoppelingen

Afsluiters

Roestvast staal

Fittingen

Luchtconditionering

Gereedschap

Pneumatiek

Diversen

Malleerbare fittingen & staal

Ringleidingssystemen

Slangen

Compressoren

LUCHTBEDIENDE VENTIELEN



Temperatuur:
-10°C tot +60°C



Maximale werkdruk:
Monostabiel: 2 tot 10 bar
Bistabiel: 1 tot 10 bar



1/8": 740 NI/min
1/4": 1200 NI/min



Huis: geanodiseerd aluminium
Spoel: chemisch vernikkeld
Seals: NBR

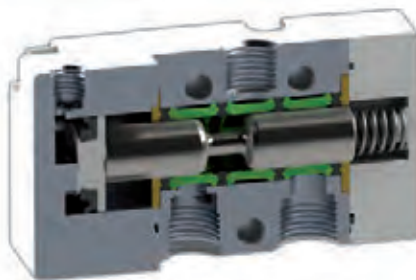

Luchtbediende 3/2 ventielen

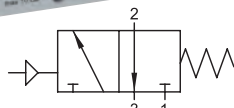

NC - monostabiel veer retour

6690	BSPP	€
01VP03NC02	1/8"	51.05
01VP03NC03	1/4"	53.20

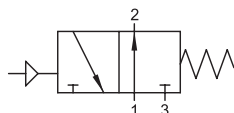

NO - monostabiel veer retour

6690	BSPP	€
01VP03NO02	1/8"	51.05
01VP03NO03	1/4"	53.20

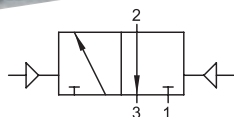

Bistabiel

6690	BSPP	€
01VP130002	1/8"	58.15
01VP130003	1/4"	60.55

Luchtbediende 5/2 ventielen

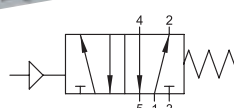
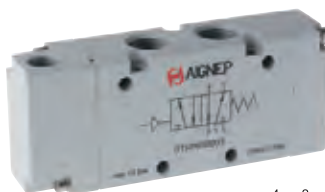

Monostabiel veer retour

6690	BSPP	€
01VP050002	1/8"	56.85
01VP050003	1/4"	60.95

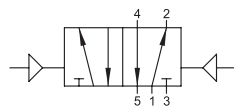

Bistabiel

6690	BSPP	€
01VP150002	1/8"	66.35
01VP150003	1/4"	69.00

Luchtbediende 5/3 ventielen

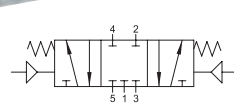

Monostabiel veer retour - CC middenstand gesloten

6690	BSPP	€
01VP07CC02	1/8"	68.25
01VP07CC03	1/4"	70.60

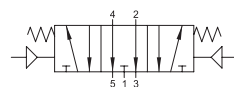

Monostabiel veer retour - OC middenstand geopend

6690	BSPP	€
01VP07OC02	1/8"	68.25
01VP07OC03	1/4"	70.60

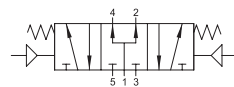

Monostabiel veer retour - PC middenstand onder druk

6690	BSPP	€
01VP07PC02	1/8"	68.25
01VP07PC03	1/4"	70.60

KELM™
pneumatiek

Hydrauliek

Snel-
koppelingen

Afsluiters

Roestvast
staal

Fittingen

Lucht-
conditionering

Gereedschap

Pneumatiek

Diversen

Malleabele
fittingen
& staal

Ringleiding-
systemen

Slangen

Compressoren

HANDBEDIENDE VENTIELEN



Temperatuur:
-10°C tot +60°C



Maximale werkdruk:
0 tot 10 bar



1/8": 740 NL/min
1/4": 1200 NL/min



Huis: geanodiseerd aluminium
Spoel: chemisch vernikkeld
Seals: NBR

Paneelmontage:
M16x1

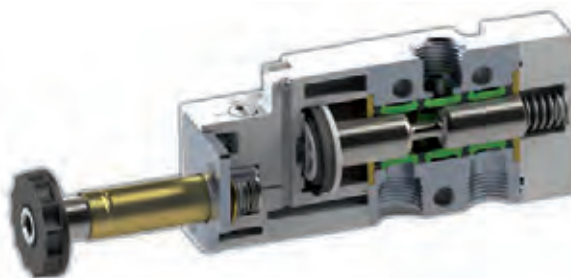

Hoofdstuk 9 – Pneumatiek

Handbediende 3/2 ventielen - trek/drukknop

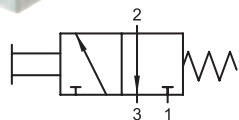

NC - monostabiel veer retour



01VT03NC02
01VT03NC03

1/8"
1/4"

53.45
58.15

Handbediende 5/2 ventielen - trek/drukknop

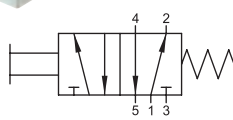

Monostabiel veer retour



01VT050002
01VT050003

1/8"
1/4"

62.30
68.15

Handbediende 3/2 ventielen - 90° hefboom

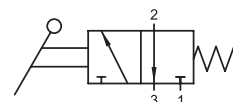

NC - monostabiel veer retour



01VL03NC02
01VL03NC03

1/8"
1/4"

62.60
66.55

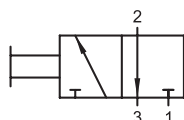

Bistabiel



01VT130002
01VT130003

1/8"
1/4"

53.45
58.15

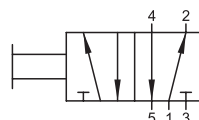

Bistabiel



01VT150002
01VT150003

1/8"
1/4"

62.30
68.15

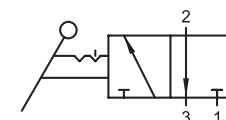

Bistabiel



01VL130002
01VL130003

1/8"
1/4"

65.30
70.20

Handbediende 5/2 ventielen - 90° hefboom

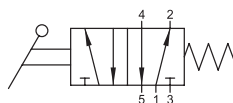

Monostabiel veer retour

6690		
01VL050002	1/8"	71.35
01VL050003	1/4"	77.00

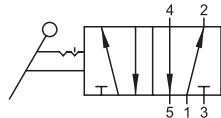

Bistabiel

6690		
01VL150002	1/8"	73.70
01VL150003	1/4"	80.40

Handbediende 5/3 ventielen - 90° hefboom

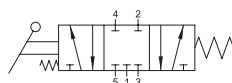

Monostabiel veer retour - CC middenstand gesloten

6690		
01VL07CC02	1/8"	79.25
01VL07CC03	1/4"	86.30



Monostabiel veer retour - OC middenstand geopend

6690		
01VL07OC02	1/8"	79.25
01VL07OC03	1/4"	86.30

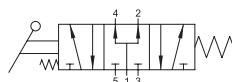

Monostabiel veer retour - PC middenstand onder druk

6690		
01VL07PC02	1/8"	79.25
01VL07PC03	1/4"	86.30

Bistabiel - CC middenstand gesloten

6690		
01VL27CC02	1/8"	79.25
01VL27CC03	1/4"	86.30

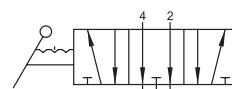

Bistabiel - OC middenstand geopend

6690		
01VL27OC02	1/8"	79.25
01VL27OC03	1/4"	86.30

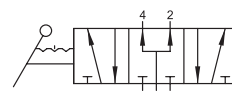

Bistabiel - PC middenstand onder druk

6690		
01VL27PC02	1/8"	79.25
01VL27PC03	1/4"	86.30

KELM™
pneumatiek

Hydrauliek

Snelkoppelingen

Afsluiters

Roestvast staal

Fittingen

Luchtconditionering

Gereedschap

Pneumatiek

Diversen

Malleabele fittingen & staal

Ringleidingssystemen

Slangen

Compressoren

Basisplaten

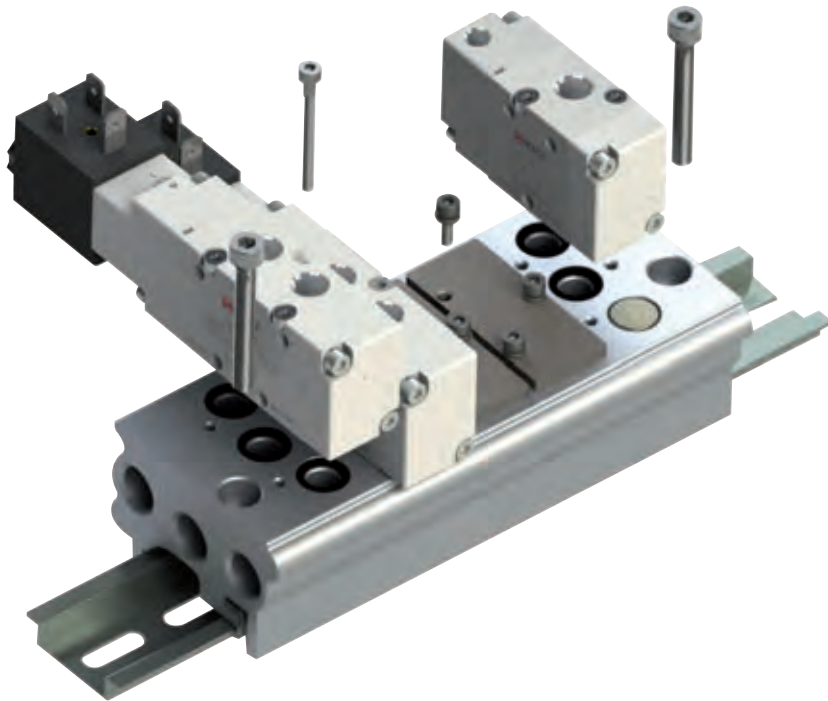

1/8" - compleet met schroeven en O-ring

6690	BSPP	No. of Stations	€
01VB000002	1/8"	2	45.55
01VB000003	1/8"	3	53.05
01VB000004	1/8"	4	59.95
01VB000005	1/8"	5	66.45
01VB000006	1/8"	6	72.20
01VB000007	1/8"	7	78.95
01VB000008	1/8"	8	85.50
01VB000009	1/8"	9	93.60
01VB000010	1/8"	10	103.25

1/4" - compleet met schroeven en O-ring

6690	BSPP	No. of Stations	€
01VB010002	1/4"	2	46.45
01VB010003	1/4"	3	54.20
01VB010004	1/4"	4	62.30
01VB010005	1/4"	5	68.80
01VB010006	1/4"	6	75.35
01VB010007	1/4"	7	82.25
01VB010008	1/4"	8	89.55
01VB010009	1/4"	9	97.65
01VB010010	1/4"	10	106.15

Accessoires basisplaten



Pluggen voor drieweg ventileaansluiting

6690	BSPP	€
01VB600000	1/8"	1.50
01VB600001	1/4"	1.65



Pluggen voor basisplaat

6690	BSPP	€
01VB800000	1/8"	1.50
01VB800001	1/4"	1.65

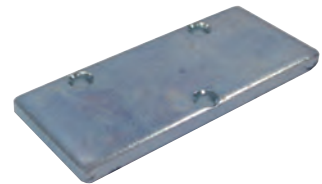

Blindplaten

6690	BSPP	€
01VB900000	1/8"	2.95
01VB900001	1/4"	3.25

KELM™
pneumatiek

Hydrauliek

Snel-
koppelingen

Afsluiters

Roestvast
staal

Fittingen

Lucht-
conditionering

Gereedschap

Pneumatiek

Diversen

Malleabele
fittingen
& staal

Ringleiding-
systemen

Slangen

Compressoren

MAGNEETVENTIELEN



Temperatuur:
-10°C tot +60°C



Maximale werkdruk:
0 tot 10 bar



300 NI/min



Huis: geanodiseerd aluminium
Seals: NBR

Magneetventielen worden standaard
geleverd zonder spoel en stekker.



Magneetventielen 3/2

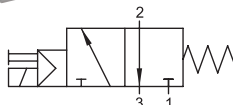

NC - met manual override



07VS03NC02 1/8" 34.90
07VS03NCX1 4mm 40.75

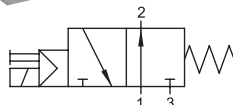

NO - met manual override



07VS03NO02 1/8" 34.90
07VS03NOX1 4mm 40.75

Spoelen en stekkers

Voltage tolerantie: ±10%
Isolatieklasse: F CEI EN 60085
IP65 IEC 60529 met stekker



Spoelen - DIN 43650 B



SOL01012C1000	12V DC 3W	10.35
SOL01024A2000	24V AC 5VA	10.35
SOL01024C1000	24V DC 3W	10.35
SOL01024C3000	12V DC 2W	10.35
SOL01110A2000	110V AC 5VA	10.35
SOL01220A2000	220V AC 5VA	10.35

Isolatieklasse: IP65 IEC 60529 met stekker
Kabeldiameter: 6-8mm



Stekkers - standaard



CON0100001 standaard A 2 pins Zwart 2.35

Isolatieklasse: IP65 IEC 60529 met stekker
Kabeldiameter: 6-8mm



Stekkers - LED



CON0202400	LED+VDR 0-24V	Transparant	10.05
CON0211000	LED+VDR 110V	Transparant	10.05
CON0225000	LED+VDR 220V	Transparant	10.05

KELM™
pneumatiek

Hydrauliek

Snel-
koppelingen

Afsluiters

Roestvast
staal

Fittingen

Lucht-
conditionering

Gereedschap

Pneumatiek

Diversen

Malleabele
fittingen
& staal

Ringleiding-
systemen

Slangen

Compressoren

HANDBEDIENDE VENTIELEN



AIRCOMP



Temperatuur:
-5°C tot 50°C

Voetbediend pneumatisch -10°C tot 50°C
Voetbediend elektrisch -25°C tot 70°C

Medium:

Gesmeerde of ongesmeerde
geconditioneerde perslucht



Flow
Serie 100: 75 l/min bij 6 bar /ΔP 1
Serie 120: 490 l/min bij 6 bar /ΔP 1
Serie 125: 800 l/min bij 6 bar /ΔP 1
Serie 140: 8mm: 75 l/min bij 6 bar /ΔP 1
Serie 140: 1/4" 550 l/min bij 6 bar /ΔP 1



Huis Kunststof (technopolymeer)
Delen, messing en RVS



NBR

Van alle Aircomp producten zijn op aanvraag technische tekeningen met inbouwmaten beschikbaar.

Serie 120 Ventielen met technopolymeer huis. Geschikt voor single use.
Serie 125 Ventielen met technopolymeer huis. Geschikt voor single use & battery assembly.

Serie 120 - 1/8"



Maximale werkdruk:
0 - 10 bar



Zij-Tuimelaar



Trek/Druk



Tuimelaar

3/2 handbediend ventiel - 1/8" BSP female

VEN		Funcctie	Lucht	€
2038-6470	AC HB 3/2 1/8" NC DK Handbediend met Drukknop, Veerretour		1/8"	28.70
2038-6488	AC HB 3/2 1/8" DK Handbediend met Trek/Drukknop		1/8"	28.70
2038-6496	AC HB 3/2 1/8" NC TUI Handbediend met Tuimelaar, Veerretour		1/8"	34.35
2038-6504	AC HB 3/2 1/8" TUI Handbediend met Tuimelaar		1/8"	31.05
2038-6512	AC HB 3/2 1/8" NC ZTUI Handbediend met Zij-Tuimelaar, Veerretour		1/8"	35.75
2038-6520	AC HB 3/2 1/8" ZTUI Handbediend met Zij-Tuimelaar		1/8"	35.60

5/2 handbediend ventiel - 1/8" BSP female

VEN		Funcctie	Lucht	€
2038-6538	AC HB 5/2 1/8" DK Veerr Handbediend met Drukknop, Veerretour		1/8"	31.95
2038-6546	AC HB 5/2 1/8" DK Handbediend met Trek/Drukknop		1/8"	31.95
2038-6595	AC HB 5/2 1/8" TUI Veerr Handbediend met Tuimelaar, Veerretour		1/8"	35.30
2038-6603	AC HB 5/2 1/8" TUI Handbediend met Tuimelaar		1/8"	34.25

5/3 handbediend ventiel - 1/8" BSP female

VEN		Funcctie	Lucht	€
2038-6553	AC HB 5/3 1/8" DK Mid Gesloten RTC Handbediend met Drukknop, Return To Centre		1/8"	41.05
2038-6561	AC HB 5/3 1/8" DK Mid Geopend RTC Handbediend met Drukknop, Return To Centre		1/8"	41.05
2038-6587	AC HB 5/3 1/8" DK Mid Druk RTC Handbediend met Drukknop, Return To Centre		1/8"	41.05
2038-6611	AC HB 5/3 1/8" TUI Mid Gesloten Handbediend met Tuimelaar		1/8"	51.35
2038-6629	AC HB 5/3 1/8" TUI Mid Geopend Handbediend met Tuimelaar		1/8"	51.35
2038-6637	AC HB 5/3 1/8" TUI Mid Druk Handbediend met Tuimelaar		1/8"	51.35
2038-6645	AC HB 5/3 1/8" TUI Mid Gesl RTC Handbediend met Tuimelaar, Return To Centre		1/8"	50.95
2038-6652	AC HB 5/3 1/8" TUI Mid Geop RTC Handbediend met Tuimelaar, Return To Centre		1/8"	50.95
2038-6660	AC HB 5/3 1/8" TUI Mid Druk RTC Handbediend met Tuimelaar, Return To Centre		1/8"	50.95

5/2 handbediend ventiel - zij uitvoering - 1/8" BSP female

VEN		Funcctie	Lucht	€
2038-6678	AC HB 5/2 1/8" ZTUI Veerr Handbediend met Zij-Tuimelaar, Veerretour		1/8"	39.20
2038-6686	AC HB 5/2 1/8" TUI Handbediend met Zij-Tuimelaar		1/8"	39.20

5/3 handbediend ventiel - zij uitvoering - 1/8" BSP female

VEN		Funcctie	Lucht	€
2038-6694	AC HB 5/3 1/8" ZTUI Mid Gesl Handbediend met Zij-Tuimelaar		1/8"	41.05
2038-6702	AC HB 5/3 1/8" ZTUI Mid Geop Handbediend met Zij-Tuimelaar		1/8"	41.05
2038-6710	AC HB 5/3 1/8" ZTUI Mid Druk Handbediend met Zij-Tuimelaar		1/8"	41.05
2038-6728	AC HB 5/3 1/8" ZTUI Mid Gesl RTC Handbediend met Zij-Tuimelaar, Return To Centre		1/8"	44.00
2038-6736	AC HB 5/3 1/8" ZTUI Mid Geop RTC Handbediend met Zij-Tuimelaar, Return To Centre		1/8"	44.00
2038-6744	AC HB 5/3 1/8" ZTUI Mid Druk RTC Handbediend met Zij-Tuimelaar, Return To Centre		1/8"	44.00



Serie 125 - 1/4"



5/2 handbediend ventiel - 1/4" BSP female

VEN	Funcie	Lucht	€
1252335001	AC HB 5/2 1/4" DK Veer Handbediend met Drukknop, Veerretour		1/4" 35.30
1252335002	AC HB 5/2 1/4" DK Handbediend met Trek/Drukknop		1/4" 35.30
1252335003	AC HB 5/2 1/4" TUI Veerretour Handbediend met Tuimelaar, Veerretour		1/4" 38.85
1252335004	AC HB 5/2 1/4" TUI Handbediend met Tuimelaar		1/4" 37.65

5/3 handbediend ventiel - 1/4" BSP female

VEN	Funcie	Lucht	€
1252336013	AC HB 5/3 1/4" DK Mid Gesl RTC Handbediend met Drukknop, Return To Centre		1/4" 45.20
1252336014	AC HB 5/3 1/4" DK Mid Geop RTC Handbediend met Drukknop, Return To Centre		1/4" 45.20
1252336015	AC HB 5/3 1/4" DK Mid Druk RTC Handbediend met Drukknop, Return To Centre		1/4" 45.20
1252336001	AC HB 5/3 1/4" TUI Mid Gesl Handbediend met Tuimelaar		1/4" 50.40
1252336002	AC HB 5/3 1/4" TUI Mid Geop Handbediend met Tuimelaar		1/4" 50.40
1252336003	AC HB 5/3 1/4" TUI Mid Druk Handbediend met Tuimelaar		1/4" 50.40
1252336004	AC HB 5/3 1/4" TUI Mid Gesl RTC Handbediend met Tuimelaar, Return To Centre		1/4" 53.20
1252336005	AC HB 5/3 1/4" TUI Mid Geop RTC Handbediend met Tuimelaar, Return To Centre		1/4" 53.20
1252336006	AC HB 5/3 1/4" TUI Mid Druk RTC Handbediend met Tuimelaar, Return To Centre		1/4" 53.20

5/2 handbediend ventiel - zij uitvoering - 1/4" BSP female

VEN	Funcie	Lucht	€
1252335005	AC HB 5/2 1/4" ZTUI Veer Handbediend met Zij-Tuimelaar, Veerretour		1/4" 43.15
1252335006	AC HB 5/2 1/4" ZTUI Handbediend met Zij-Tuimelaar		1/4" 43.15

5/3 handbediend ventiel - zij uitvoering - 1/4" BSP female

VEN	Funcie	Lucht	€
1252336007	AC HB 5/3 1/4" ZTUI Mid Gesl Handbediend met Zij-Tuimelaar		1/4" 45.20
1252336008	AC HB 5/3 1/4" ZTUI Mid Geop Handbediend met Zij-Tuimelaar		1/4" 45.20
1252336009	AC HB 5/3 1/4" ZTUI mid druk Handbediend met Zij-Tuimelaar		1/4" 45.20
1252336010	AC HB 5/3 1/4" ZTUI Mid Gesl RTC Handbediend met Zij-Tuimelaar, Return to Centre		1/4" 48.55
1252336011	AC HB 5/3 1/4" ZTUI Mid Geop RTC Handbediend met Zij-Tuimelaar, Return to Centre		1/4" 48.55
1252336012	AC HB 5/3 1/4" ZTUI Mid Druk RTC Handbediend met Zij-Tuimelaar, Return to Centre		1/4" 48.55

Serie 100 - 4mm push-in



2/2 handbediend micro ventiel - exclusief schakelaar - 4mm push-in

VEN	Funcie	Lucht	€
2038-6231	AC Micro HB 2/2 4mm NC ZS Handbediend, NC, Zonder Schakelaar		4mm Push-in 12.05

3/2 handbediend micro ventiel - exclusief schakelaar - 4mm push-in

VEN	Funcie	Lucht	€
2038-6330	AC Micro HB 3/2 4mm NC ZS Handbediend, NC, Zonder Schakelaar		4mm Push-in 12.05
2038-6348	AC Micro HB 3/2 4mm NO ZS Handbediend, NO, Zonder Schakelaar		4mm Push-in 13.30

Serie 100 - M5



2/2 handbediend micro ventiel - exclusief schakelaar - M5 female

VEN	Funcie	Lucht	€
2038-6058	AC Micro HB 2/2 M5 NC ZS Handbediend, NC, Zonder Schakelaar		M5 10.25

3/2 handbediend micro ventiel - exclusief schakelaar - M5 female

VEN	Funcie	Lucht	€
2038-6157	AC Micro HB 3/2 M5 NC ZS Handbediend, NC, Zonder Schakelaar		M5 10.25
2038-6165	AC Micro HB 3/2 M5 NO ZS Handbediend, NO, Zonder Schakelaar		M5 11.60

Voor basisplaten serie 125 zie pagina 523

HANDBEDIENDE VENTIELEN



AIRCOMP
Industrial Quality

Serie 120 - 1/8"



Maximale
werkdruk:
0 - 10 bar

Let op: deze ventielen
worden geleverd zonder
schakelaar.



3/2 handbediend ventiel -
exclusief schakelaar - 1/8" BSP female



2038-6942	AC HB 3/2 1/8" NC ZS Handbediend, NC, Zonder Schakelaar		1/8"	32.25
2038-6959	AC HB 3/2 1/8" NO ZS Handbediend, NO, Zonder Schakelaar		1/8"	32.25

5/2 handbediend ventiel - exclusief schakelaar - 1/8" BSP female



2038-7064	AC HB 5/2 1/8" ZS Handbediend, Zonder Schakelaar		1/8"	35.75
------------------	---	--	------	--------------

Schakelaars

Schakelaars met
metalen behuizing voor
handbediende ventielen
zonder schakelaar van
serie 100, 120 en 125.



Sleutelschakelaar



2038-7296	AC SSSCHA-M 2S Sleutel Sleutelschakelaar, 2 Standen			36.70
------------------	--	--	--	--------------

Draaischakelaar



2038-7304	AC SCHA-M 2S Draai 29,5 Draaischakelaar, 2 Standen, Handel 29,5mm			22.45
2038-7312	AC SCHA-M 2S draai 29,5, VR Draaischakelaar, 2 Standen, Veerretour, Handel 29,5mm			22.45
2038-7320	AC SCHA-M 3S Draai 29,5 Draaischakelaar, 3 Standen, Handel 29,5mm			22.45
2038-7338	AC SCHA-M 3S Draai 29,5, RTC Draaischakelaar, 3 Standen, Return to Centre, Handel 29,5mm			22.45
2038-7346	AC SCHA-M 2S Draai 39 Draaischakelaar, 2 Standen, Handel 39mm			23.25
2038-7361	AC SCHA-M 2S Draai 39, VR Draaischakelaar, 2 Standen, Veerretour, Handel 39mm			23.25
2038-7379	AC SCHA-M 3S Draai 39 Draaischakelaar, 3 Standen, Handel 39mm			23.25
2038-7387	AC SCHA-M 3S Draai 39, RTC Draaischakelaar, 3 Standen, Return to Centre, Handel 39mm			23.25

Drukknopschakelaar (zonder knopkap)



2038-7403	AC M Drukknop (zonder knopkap)			12.30
------------------	--------------------------------	--	--	--------------

Serie 125 - 1/4"



Maximale
werkdruk:
1 - 10 bar



5/2 handbediend ventiel -
exclusief schakelaar - 1/4" BSP female



1252535005	AC HB 5/2 1/4" ZS Handbediend, Zonder Schakelaar		1/4"	39.20
-------------------	---	--	------	--------------

Knopkap (t.b.v. drukknopschakelaar)



1003A00048	AC Knopkap, Zwart T.b.v. Drukknopschakelaar		4.70
1003A00049	AC Knopkap, Rood T.b.v. Drukknopschakelaar		3.40
2038-7429	AC Knopkap, Blauw T.b.v. Drukknopschakelaar		4.40
2038-7437	AC Knopkap, Geel T.b.v. Drukknopschakelaar		4.40
2038-7445	AC Knopkap, Groen T.b.v. Drukknopschakelaar		4.40

Paddestoelschakelaar



2038-7510	AC BI 40mm Paddestoel, Rood Bidirectionele Paddestoelschakelaar		18.20
2038-7528	AC BI 40mm Paddestoel Zwart Bidirectionele Paddestoelschakelaar		17.85
2038-7585	AC DR 40mm Paddestoel, Rood Om as Draaiende Paddestoelschakelaar		29.05
2038-7593	AC DR 60mm Paddestoel, Rood Om as Draaiende Paddestoelschakelaar		33.80

Pookschakelaar



2038-7577	AC MU Pook, Rood Multidirectionele Pookschakelaar		26.10
------------------	--	--	--------------

KELM™
pneumatiek

Hydrauliek

Snel-
koppelingen

Afsluiters

Roestvast
staal

Fittingen

Lucht-
conditionering

Gereedschap

Pneumatiek

Diversen

Malleabele
fittingen
& staal

Ringleiding-
systemen

Slangen

Compressoren

Serie 100 - 4mm push-in



VEN		Funcie	Lucht	€
2038-6199	AC Micro MB 2/2 4mm NC SB Mechanisch, Stiftbediend		4mm Push-in	11.70
2038-6223	AC Micro MB 2/2 4mm NC SB Pan Mechanisch, Stiftbediend, Paneelmontage		4mm Push-in	13.10
2038-6249	AC Micro MB 2/2 4mm NC Hef Mechanisch Bediend met Hefboom		4mm Push-in	13.20

3/2 mechanisch bediend micro ventiel - 4mm push-in

VEN		Funcie	Lucht	€
2038-6256	AC Micro MB 3/2 4mm NC SB Mechanisch, Stiftbediend		4mm Push-in	11.70
2038-6264	AC Micro MB 3/2 4mm NO SB Mechanisch, Stiftbediend		4mm Push-in	13.10
2038-6314	AC Micro MB 3/2 4mm NC SB Pan Mechanisch, Stiftbediend, Paneelmontage		4mm Push-in	13.10
2038-6322	AC Micro MB 3/2 4mm NO SB Pan Mechanisch, Stiftbediend, Paneelmontage		4mm Push-in	14.45
2038-6355	AC Micro MB 3/2 4mm NC Hef Mechanisch Bediend met Hefboom		4mm Push-in	13.20
2038-6363	AC Micro MB 3/2 4mm NC Hef Mechanisch Bediend met Hefboom		4mm Push-in	14.65

Serie 100 - M5



2/2 mechanisch bediend micro ventiel - M5 female

VEN		Funcie	Lucht	€
2038-5852	AC Micro MB 2/2 M5 NC SB Mechanisch, Stiftbediend		M5	9.95
2038-6041	AC Micro MB 2/2 M5 NC SB Pan Mechanisch, Stiftbediend, Paneelmontage		M5	11.25
2038-6066	AC Micro MB 2/2 M5 NC Hef Mechanisch Bediend met Hefboom		M5	11.60

3/2 mechanisch bediend micro ventiel - M5 female

VEN		Funcie	Lucht	€
2038-6074	AC Micro MB 3/2 M5 NC SB Mechanisch, Stiftbediend		M5	9.95
2038-6082	AC Micro MB 3/2 M5 NO SB Mechanisch, Stiftbediend		M5	11.25
2038-6132	AC Micro MB 3/2 M5 NC SB Pan Mechanisch, Stiftbediend, Paneelmontage		M5	11.25
2038-6140	AC Micro MB 3/2 M5 NO SB Pan Mechanisch, Stiftbediend, Paneelmontage		M5	12.70
2038-6173	AC Micro MB 3/2 M5 NC Hef Mechanisch Bediend met Hefboom		M5	11.60
2038-6181	AC Micro MB 3/2 M5 NO Hef Mechanisch Bediend met Hefboom		M5	12.80

Serie 120 - 1/8"

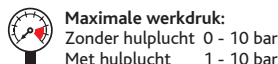

1 Richting

3/2 mechanisch bediend ventiel - 1/8" BSP female

VEN		Funcie	Lucht	€
2038-6751	AC MB 3/2 1/8" NC SB Mechanisch, Stiftbediend		1/8"	24.65
2038-6769	AC MB 3/2 1/8" NO SB Mechanisch, Stiftbediend		1/8"	24.65
2038-6777	AC MB 3/2 1/8" NC SB-HL Mechanisch, Stiftbediend, Hulplucht		1/8"	31.40
2038-6785	AC MB 3/2 1/8" NO SB-HL Mechanisch, Stiftbediend, Hulplucht		1/8"	31.40
2038-6793	AC MB120 3/2 1/8" NC SB-HL Pan Mechanisch, Stiftbediend, Hulplucht, Paneelmontage		1/8"	33.45
2038-6819	AC MB 3/2 1/8" NO SB-HL Pan Mechanisch, Stiftbediend, Hulplucht, Paneelmontage		1/8"	33.45
2038-6827	AC MB 3/2 1/8" NC VRA Mechanisch, Verlengde Rolarm Bediend		1/8"	33.00
2038-6835	AC MB 3/2 1/8" NO VRA Mechanisch, Verlengde Rolarm Bediend		1/8"	33.00
2038-6868	AC MB 3/2 1/8" NC RA-HL Mechanisch, Rolarm Bediend, Hulplucht		1/8"	37.30
2038-6876	AC MB 3/2 1/8" NO RA-HL Mechanisch, Rolarm Bediend, Hulplucht		1/8"	37.30
2038-6843	AC MB 3/2 1/8" NC RA1 Mechanisch, Rolarm Bediend, 1 Richting		1/8"	35.50
2038-6850	AC MB 3/2 1/8" NO RA1 Mechanisch, Rolarm Bediend, 1 Richting		1/8"	35.50
2038-6884	AC MB 3/2 1/8" NC RA1-HL Mechanisch, Rolarm Bediend, 1 Richting, Hulplucht		1/8"	39.45
2038-6892	AC MB 3/2 1/8" NO RA1-HL Mechanisch, Rolarm Bediend, 1 Richting, Hulplucht		1/8"	39.45
2038-6900	AC MB 3/2 1/8" NC HEF-HL Mechanisch, Hefboom Bediend, Hulplucht		1/8"	34.80
2038-6918	AC MB 3/2 1/8" NO HEF-HL Mechanisch, Hefboom Bediend, Hulplucht		1/8"	34.80
2038-6926	AC MB 3/2 1/8" NC ANT Mechanisch, Antenne Bediend		1/8"	36.45
2038-6934	AC MB 3/2 1/8" NO ANT Mechanisch, Antenne Bediend		1/8"	36.45

KELM™
pneumatiek

Hydrauliek

Snel-
koppelingen

Afsluiters

Roestvast
staal

Fittingen

Lucht-
conditionering

Gereedschap

Pneumatiek

Diversen

Malleabele
fittings
& staal

Ringleiding-
systemen

Slangen

Compressoren

MECHANISCH BEDIENDE VENTIELEN



AIRCOMP

Serie 120 - 1/8"



Maximale werkdruk:
Zonder hulplucht 0 - 10 bar
Met hulplucht 1 - 10 bar



1 Richting

5/2 mechanisch bediend ventiel - 1/8" BSP female

VEN		Functie	Lucht	€
2038-6975	AC MB 5/2 1/8" SB Veerr Mechanisch, Stiftbediend		1/8"	28.35
2038-6983	AC MB 5/2 1/8" SB-HL Veerr Mechanisch, Stiftbediend, Hulplucht		1/8"	34.80
2038-6991	AC MB 5/2 1/8" SB-HL Pan Veerr Mechanisch, Stiftbediend, Hulplucht, Paneelmontage		1/8"	41.50
2038-7007	AC MB 5/2 1/8" RA Veerr Mechanisch, Verlengde Rolarm Bediend		1/8"	37.10
2038-7023	AC MB 5/2 1/8" RA-HL Veerr Mechanisch, Rolarm Bediend, Hulplucht		1/8"	41.40
2038-7015	AC MB 5/2 1/8" RA1 Veerr Mechanisch, Rolarm Bediend, 1 Richting		1/8"	39.80
2038-7031	AC MB 5/2 1/8" RA1-HL Veerr Mechanisch, Rolarm Bediend, 1 Richting, Hulplucht		1/8"	43.65
2038-7049	AC MB 5/2 1/8" HEF-HL Veerr Mechanisch, Hefboom Bediend, Hulplucht		1/8"	38.25
2038-7056	AC MB 120 5/2 1/8" ANT-HL Veerr Mechanisch, Antenne Bediend, Hulplucht		1/8"	39.60

Serie 125 - 1/4"



Maximale werkdruk:
Zonder hulplucht 0 - 10 bar
Met hulplucht 1 - 10 bar



1 Richting

5/2 mechanisch bediend ventiel - 1/4" BSP female

VEN		Functie	Lucht	€
1252435001	AC MB 5/2 1/4" SB Veerr Mechanisch, Stiftbediend		1/4"	31.15
1252535001	AC MB 5/2 1/4" SB-HL Veerr Mechanisch, Stiftbediend, Hulplucht		1/4"	38.35
1252535004	AC MB 5/2 1/4" SB-HL Pan Veerr Mechanisch, Stiftbediend, Hulplucht, Paneelmontage		1/4"	43.25
1252435002	AC MB 5/2 1/4" RA Veerr Mechanisch, Rolarm Bediend		1/4"	37.90
1252535002	AC MB 5/2 1/4" RA-HL Veerr Mechanisch, Rolarm Bediend, Hulplucht		1/4"	45.35
1252435003	AC MB 5/2 1/4" RA1 Veerr Mechanisch, Rolarm Bediend, 1 Richting		1/4"	39.95
1252535003	AC MB 5/2 1/4" RA1-HL Veerr Mechanisch, Rolarm Bediend, 1 Richting, Hulplucht		1/4"	47.95
1252435006	AC MB 5/2 1/4" BA Veerr Mechanisch, Balarm Bediend		1/4"	39.60
1252435007	AC MB 5/2 1/4" BA1 Veerr Mechanisch, Balarm Bediend, 1 Richting		1/4"	41.65
1252535006	AC MB 5/2 1/4" HEF-HL Veerr Mechanisch, Hefboom Bediend, Hulplucht		1/4"	41.85
1252535007	AC MB 5/2 1/4" ANT Veerr Mechanisch, Antenne Bediend		1/4"	39.00

Hoofdstuk 9 – Pneumatiek

KELMTM pneumatiek

Hydrauliek

Snelkoppelingen

Afsluiters

Roestvast staal

Fittingen

Luchtconditionering

Gereedschap

Pneumatiek

Diversen

Malleabele fittingen & staal

Ringleidingssystemen

Slangen

Compressoren

Voor

AIRCOMP

FRL's

zie hoofdstuk 7



VOETBEDIENDE VENTIELEN



AIRCOMP

Temperatuur:
-10°C t/m 50°C

Maximale werkdruk:
2 - 10 bar

Serie 140 - 4mm push-in



3/2 voetbediend micro ventiel - monostabiel - zonder beschermkap - 4mm push-in

VEN



Functie



PED304M AC Micro VB 3/2 4mm MS Voetbediend, Monostabiel

4mm Push-in **43.35**



3/2 voetbediend ventiel - monostabiel - 4mm push-in

VEN



Functie



1407493001 AC VB 3/2 4mm BK MS Voetbediend, Beschermkap, Monostabiel

4mm Push-in **43.90**

3/2 voetbediend ventiel - bistabiel - 4mm push-in

VEN



Functie



1407493003 AC VB 3/2 4mm BK BS Voetbediend, Beschermkap, Bistabiel

4mm Push-in **46.70**

Voor

AIRCOMP

terugslagkleppen
zie hoofdstuk 4



Serie 140 - 1/4"



5/2 voetbediend ventiel - monostabiel - zonder beschermkap - 1/4" BSP female

VEN



Functie



PED5502M AC VB 5/2 1/4" MS Voetbediend, Monostabiel

1/4" **57.70**

5/2 voetbediend ventiel - bistabiel - zonder beschermkap - 1/4" BSP female

VEN



Functie



1407535005 AC VB 5/2 1/4" BS Voetbediend, Bistabiel

1/4" **61.15**



5/2 voetbediend ventiel - monostabiel - 1/4" BSP female

VEN



Functie



PED502S AC VB 5/2 1/4" BK MS Voetbediend, Beschermkap, Monostabiel

1/4" **64.60**

5/2 voetbediend ventiel - bistabiel - 1/4" BSP female

VEN



Functie



PED502B AC VB 5/2 1/4" BK BS Voetbediend, Beschermkap, Bistabiel

1/4" **68.20**

Serie 140 - elektrische schakelaar 24/230V

Temperatuur:
-25°C t/m 70°C

Verschillende uitvoeringen zijn leverbaar met safety device.

Voetbediend ventiel - elektrische schakelaar 24/230V - monostabiel - levering met kabel

VEN



1407660801 AC VB Elektr Schak BK MS Voetbediend, Beschermkap, Monostabiel

42.55

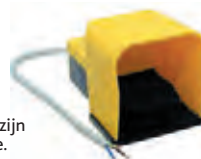

KELM™ pneumatiek

Hydrauliek

Snelkoppelingen

Afsluiters

Roestvast staal

Fittingen

Luchtconditionering

Gereedschap

Pneumatiek

Diversen

Malleabele fittingen & staal

Ringleidingssystemen

Slangen

Compressoren

LUCHTBEDIENDE VENTIELEN



AIRCOMP

Medium:

Gesmeerde of ongesmeerde geconditioneerde perslucht



Temperatuur: -5°C tot 50°C



FLOW Serie 120: 490 L/min bij 6 bar /ΔP 1
Serie 125: 800 L/min bij 6 bar /ΔP 1



Huis Kunststof (technopolymeer)
Delen, messing en RV5



NBR

Serie 120 - 1/8"



Maximale werkdruk:

Werkdruk: 0 - 10 bar

Stuurdruk: Monostabiel: 1 - 10. bar

Bistabiel: 0,5 - 10 bar



3/2 luchtbediend ventiel - 1/8" BSP female

VEN		Functie	Lucht	€
2038-6371	AC LB 3/2 1/8" HL NC Lucht - Veer, Hulplucht		1/8"	25.40
2038-6389	AC LB 3/2 1/8" HL NO Lucht - Veer, Hulplucht		1/8"	25.40
2038-6397	AC LB 3/2 1/8" Bistabiel Lucht - Lucht		1/8"	29.60
2038-6405	AC LB 3/2 1/8" Differentieel Lucht - Lucht, Luchtretour		1/8"	30.55

5/2 luchtbediend ventiel - 1/8" BSP female

VEN		Functie	Lucht	€
2038-6413	AC LB 5/2 1/8" HL Veerretour Lucht - Veer, Hulplucht		1/8"	28.45
2038-6421	AC LB 5/2 1/8" Bistabiel Lucht - Lucht		1/8"	31.05
2038-6439	AC LB 5/2 1/8" Differentieel Lucht - Lucht, Luchtretour		1/8"	34.50

5/3 luchtbediend ventiel - 1/8" BSP female

VEN		Functie	Lucht	€
2038-6447	AC LB 5/3 1/8" Midden Gesloten RTC Lucht - Lucht, Return to Centre		1/8"	47.30
2038-6454	AC LB 5/3 1/8" Midden Geopend RTC Lucht - Lucht, Return to Centre		1/8"	47.30
2038-6462	AC LB 5/3 1/8" Midden Druk RTC Lucht - Lucht, Return to Centre		1/8"	47.30

Serie 125 - 8mm push-in



Maximale werkdruk:

Werkdruk: 0 - 10 bar

Stuurdruk: 5/2 Monostabiel: 1 - 10. 5/2 bar

Bistabiel/differentieel: 0,5 - 10. 5/3 bar

Bistabiel: 2,1 - 10 bar



5/2 luchtbediend ventiel - 8mm push-in

VEN		Functie	Lucht	€
1252295001	Ac Lb 5/2 8mm Veerr Lucht - Veer, Hulplucht		8mm Push-in	30.75
1252295002	Ac Lb 5/2 8mm Bistabiel Lucht - Lucht		8mm Push-in	33.35
1252295003	Ac Lb 5/2 8mm Differentieel Lucht - Lucht, Luchtretour		8mm Push-in	37.00

5/3 luchtbediend ventiel - 8mm push-in

VEN		Functie	Lucht	€
1252296001	Ac Lb 5/3 8mm Midden Gesloten Rtc Lucht - Lucht, Return To Centre		8mm Push-in	47.75
1252296002	Ac Lb 5/3 8mm Midden Geopend Rtc Lucht - Lucht, Return To Centre		8mm Push-in	47.75
1252296003	Ac Lb 5/3 8mm Midden Druk Rtc Lucht - Lucht, Return To Centre		8mm Push-in	47.75

Serie 125 - 1/4"



5/2 luchtbediend ventiel - 1/4" BSP female

VEN		Functie	Lucht	€
1252235001	AC LB 5/2 1/4" Veerr Lucht - Veer, Hulplucht		1/4"	31.05
1252235002	AC LB 5/2 1/4" Bistabiel Lucht - Lucht		1/4"	34.50
1252235003	AC LB 5/2 1/4" Differentieel Lucht - Lucht, Luchtretour		1/4"	38.95

5/3 luchtbediend ventiel - 1/4" BSP female

VEN		Functie	Lucht	€
1252236001	AC LB 5/3 1/4" Midden Gesloten RTC Lucht - Lucht, Return To Centre		1/4"	50.60
1252236002	AC LB 5/3 1/4" Midden Geopend RTC Lucht - Lucht, Return To Centre		1/4"	50.60
1252236003	AC LB 5/3 1/4" Midden Druk RTC Lucht - Lucht, Return To Centre		1/4"	50.60

ELEKTROPNEUMATISCHE SCHUIFVENTIELEN



AIRCOMP

Isolatie klasse (IP) IP65

Temperatuur: -5°C tot 50°C

Type manual override: Monostabiel

EM120
120 serie = SINGLE USE



Huis Kunststof (technopolymer)
Delen, messing en RVS



NBR



Serie 20: 490 L/min bij 6 bar /ΔP 1
Serie 125: 800 L/min bij 6 bar /ΔP 1



Type spoel = 22 mm



DC = 3 watt
AC = 7,5 VA

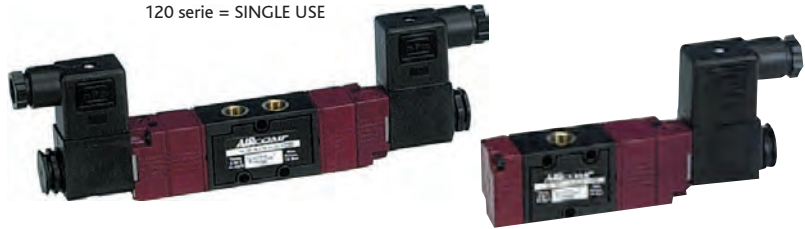

Serie 120 - 1/8"



Maximale werkdruk:
Werkdruk: Monostabiel: 1 - 10 bar
Bistabiel: 0,5 - 10 bar

3/2 schuifventiel - 1/8" BSP female - met manual override - zonder spoel en stekker



1202123001	AC EPV- 120 3/2 1/8" NC Elek/Pneu - Veer (Interne Hulplucht)		1/8"	37.45
1202123002	AC EPV-120 3/2 1/8" NO Elek/Pneu - Veer (Interne Hulplucht)		1/8"	37.45
1202123003	AC EPV-120 3/2 1/8" Elek/Pneu - Elec/pneu		1/8"	56.25



Maximale werkdruk:
Monostabiel: 1 - 10 bar
Bistabiel: 0 - 10 bar

5/2 schuifventiel - 1/8" BSP female - met manual override - zonder spoel en stekker



1202125001	AC EPV-120 5/2 1/8" VEERR Elek-Pneu - Veer (Interne Hulplucht)		1/8"	40.25
1202125002	AC EPV-120 5/2 1/8" Elek-Pneu - Elek-Pneu		1/8"	58.85

5/3 schuifventiel - 1/8" BSP female - met manual override - zonder spoel en stekker



1202126001	AC EPV-120 5/3 1/8" MC - RTC Elek-Pneu - Elek-Pneu / Middenstand Gesloten / Return to Centre		1/8"	73.95
1202126002	AC EPV-120 5/3 1/8" MO - RTC Elek-Pneu - Elek-Pneu / Middenstand Geopend / Return to Centre		1/8"	73.95
1202126003	AC EPV-120 5/3 1/8" MD - RTC Elek-Pneu - Elek-Pneu / Middenstand Onder Druk / Return to Centre		1/8"	73.95

Serie 120 - 1/8" - pilot



Maximale werkdruk:
Werkdruk: 0 - 10 bar
Stuurdruk: Monostabiel: 1 - 10 bar
Bistabiel: 0,5 - 10 bar

3/2 pilot schuifventiel - 1/8" BSP female - met manual override - zonder spoel en stekker



1202123004	AC EPV-120 3/2 1/8" AM5- NC Elek/Pneu / Pilot - Veer (Interne Hulplucht) Aansluiting Pilot: M5		1/8"	41.85
1202123007	AC EPV-120 3/2 1/8" A4MM-NC Elek/Pneu / Pilot - Veer (Interne Hulplucht) Aansluiting Pilot: 4mm Push-in		1/8"	42.85
1202123005	AC EPV-120 3/2 1/8" AM5-NO Elek/Pneu / Pilot - Veer (Interne Hulplucht) Aansluiting Pilot: M5		1/8"	41.85
1202123008	AC EPV-120 3/2 1/8" A4MM-NO Elek/Pneu / Pilot - Veer (Interne Hulplucht) Aansluiting Pilot: 4mm Push-in		1/8"	42.85
1202123006	AC EPV-120 3/2 1/8" AM5 Elek/Pneu / Pilot - Elek/Pneu / Pilot Aansluiting Pilot: M5		1/8"	63.85
1202123009	AC EPV-120 3/2 1/8" A4MM Elek/Pneu / Pilot - Elek/Pneu / Pilot Aansluiting Pilot: 4mm Push-in		1/8"	65.95



Hoofdstuk 9 – Pneumatiek

KELM™ pneumatiek

Hydrauliek

Snelkoppelingen

Afsluiters

Roestvast staal

Fittingen

Luchtconditionering

Gereedschap

Pneumatiek

Diversen

Malleabele fittingen & staal

Ringleidingssystemen

Slangen

Compressoren

ELEKTROPNEUMATISCHE SCHUIFVENTIELEN



AIRCOMP

EM120
120 serie = SINGLE USE



Serie 120 - 1/8" - pilot

Maximale werkdruk:
Werkdruk: 0 - 10 bar
Stuurdruk: 5/2: 0,5 - 10 bar. 5/3: 2,1 - 10 bar

5/2 pilot schuifventiel - 1/8" BSP female - met manual override - zonder spoel en stekker

VEN		Functie	Lucht	€
1202125003	AC EPV-120 5/2 1/8" AM5 VEERR Elek-Pneu / Pilot - Veer (Interne Hulplucht) Aansluiting Pilot: M5		1/8"	45.35
1202125005	AC EPV-120 5/2 1/8" A4MM VEERR Elek-Pneu / Pilot - Veer (Interne Hulplucht) Aansluiting Pilot: 4mm Push-in		1/8"	46.20
1202125004	AC EPV-120 5/2 1/8" AM5 Elek-Pneu / Pilot - Elek-Pneu / Pilot Aansluiting Pilot: M5		1/8"	65.95
1202125006	AC EPV-120 5/2 1/8" A4MM Elek-Pneu / Pilot - Elek-Pneu / Pilot Aansluiting Pilot: 4mm Push-in		1/8"	67.25

5/3 pilot schuifventiel - 1/8" BSP female - met manual override - zonder spoel en stekker

VEN		Functie	Lucht	€
1202126004	AC EPV-120 5/3 1/8" AM5 MC - RTC Elek-Pneu / Pilot - Elek-Pneu / Pilot / Middenstand Gesloten/Return to Centre Aansluiting Pilot: M5		1/8"	79.75
1202126007	AC EPV-120 5/3 1/8" A4MM MC - RTC Elek-Pneu / Pilot - Elek-Pneu / Pilot / Middenstand Gesloten/Return to Centre Aansluiting Pilot: 4mm Push-in		1/8"	81.40
1202126005	AC EPV-120 5/3 1/8" AM5 MO - RTC Elek-Pneu / Pilot - Elek-Pneu / Pilot / Middenstand Geopend/Return to Centre Aansluiting Pilot: M5		1/8"	79.75
1202126008	AC EPV-120 5/3 1/8" A4MM MO - RTC Elek-Pneu / Pilot - Elek-Pneu / Pilot / Middenstand Geopend/Return to Centre Aansluiting Pilot: 4mm Push-in		1/8"	81.40
1202126006	AC EPV-120 5/3 1/8" AM5 MD - RTC Elek-Pneu / Pilot - Elek-Pneu / Pilot / Middenstand Druk/Return to Centre Aansluiting Pilot: M5		1/8"	79.75
1202126009	AC EPV-120 5/3 1/8" A4MM MD - RTC Elek-Pneu / Pilot - Elek-Pneu / Pilot / Middenstand Druk/Return to Centre Aansluiting Pilot: 4mm Push-in		1/8"	81.40

EM125
125 serie = SINGLE USE
& BATTERY ASSEMBLY



Serie 125 - 1/4"

Maximale werkdruk:
Werkdruk: 5/2 met veerretour: 1 - 10 bar
5/2 zonder veerretour en 5/3: 0 - 10 bar

5/2 schuifventiel - 1/4" BSP female - met manual override - zonder spoel en stekker

VEN		Functie	Lucht	€
1252135001	AC EPV-125 5/2 1/4" VEERR Elek-Pneu - Veer (Interne Hulplucht)		1/4"	45.35
1252135002	AC EPV-125 5/2 1/4" Elek-Pneu - Elek-Pneu		1/4"	65.95

5/3 schuifventiel - 1/4" BSP female - met manual override - zonder spoel en stekker

VEN		Functie	Lucht	€
1252136001	AC EPV-125 5/3 1/4" MC - RTC Elek-Pneu - Elek-Pneu / Middenstand Gesloten/Return to Centre		1/4"	82.95
1252136002	AC EPV-125 5/3 1/4" MO - RTC Elek-Pneu - Elek-Pneu / Middenstand Geopend/Return to Centre		1/4"	82.95
1252136003	AC EPV-125 5/3 1/4" MD - RTC Elek-Pneu - Elek-Pneu / Middenstand Onder Druk/Return to Centre		1/4"	82.95

Serie 125 - 1/4" - pilot

5/2 pilot schuifventiel - 1/4" BSP female - met manual override - zonder spoel en stekker

VEN		Functie	Lucht	€
1252135003	AC EPV-125 5/2 1/4" ACTM5-VEERR Elek-Pneu / Pilot - Veer (interne hulplucht) Aansluiting Pilot: M5		1/4"	50.95
1252135004	AC EPV-125 5/2 1/4" ACTM5 Elek-Pneu / Pilot - Elek-Pneu / Pilot Aansluiting Pilot: M5		1/4"	73.60

5/3 pilot schuifventiel - 1/4" BSP female - met manual override - zonder spoel en stekker

VEN		Functie	Lucht	€
1252136004	AC EPV-125 5/3 1/4" ACTM5 MC - RTC Elek-Pneu / Pilot - Elek-Pneu / Pilot / Middenstand Gesloten/Return to Centre Aansluiting Pilot: M5		1/4"	89.45
1252136005	AC EPV-125 5/3 1/4" ACTM5 MO - RTC Elek-Pneu / Pilot - Elek-Pneu / Pilot / Middenstand Geopend/Return to Centre Aansluiting Pilot: M5		1/4"	89.45
1252136006	AC EPV-125 5/3 1/4" ACTM5 MD - RTC Elek-Pneu / Pilot - Elek-Pneu / Pilot / Middenstand Druk/Return to Centre Aansluiting Pilot: M5		1/4"	89.45

KELM™
pneumatiek

Hydrauliek

Snel-
koppelingen

Afsluiters

Roestvast
staal

Fittingen

Lucht-
conditionering

Gereedschap

Pneumatiek

Diversen

Malleabele
fittingen
& staal

Ringleiding-
systemen

Slangen

Compressoren

Spoelen en stekkers



22mm spoel - voor ventielen serie 120, 125 en EM110

VEN



A502600018	12V DC	6.05
2039-7238	24V DC	5.55
2039-7253	24V/50-60Hz AC	5.55
2039-7279	110V/50-60Hz AC	5.55
2039-7287	220V/50-60Hz AC	5.55
1341A00001	24DC EXPLOSIEVEILIG	63.05



22mm stekker

VEN



2039-7205

1.65

Basisplaat



Basisplaat - voor ventielen serie 125

VEN



2039-6727	AC Basisplaat 125, 2 Posities	15.35
2039-6735	AC Basisplaat 125, 3 Posities	21.10
2039-6743	AC Basisplaat 125, 4 Posities	26.85
2039-6750	AC Basisplaat 125, 5 Posities	32.70
2039-6768	AC Basisplaat 125, 6 Posities	38.50
2039-6776	AC Basisplaat 125, 7 Posities	44.00
2039-6784	AC Basisplaat 125, 8 Posities	49.90
2039-6792	AC Basisplaat 125, 9 Posities	55.65
2039-6800	AC Basisplaat 125, 10 Posities	61.45
2039-7932	AC Blindplaat V Basisplaat 125	1.00

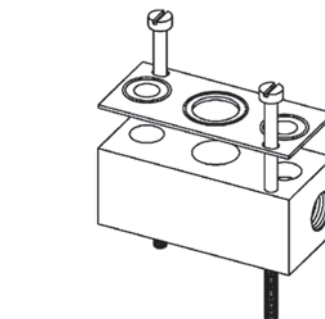

Druckscheidingskit - voor bevestiging van ventielen serie 125 op basisplaat (verschillende werkdrukken)

VEN



1325C00001

25.15

Serie EM110 - koppeling en bevestiging



Bevestigingsmoer voor spoel - bij batterijmontage ventielen serie EM110

VEN



1311A00015

0.30

KELM™
pneumatiek

Hydrauliek

Snel-
koppelingen

Afsluiters

Roestvast
staal

Fittingen

Lucht-
conditionering

Gereedschap

Pneumatiek

Diversen

Malleabele
fittingen
& staal

Ringleiding-
systemen

Slangen

Compressoren

MAGNEETVENTIELEN - BATTERIJMONTAGE



AIRCOMP

Type manual override:
Bistabiel

Isolatie klasse (IP) IP65

Temperatuur: -5°C tot 50°C

Werkdruk: 0 - 10

Huis Kunststof (PBT)
Delen, messing en RV5

NBR

0,08 KG

50 L/min bij 6 bar /ΔP

Type spoel = 22 mm

DC = 3 watt
AC = 7,5 VA

De Aircomp EM110 serie is ontwikkeld voor batterijmontage. De magneetventielen worden met een koppelingsstuk aan elkaar verbonden en kunnen aan DIN EN50022 rails worden bevestigd. Luchtaansluiting is aan 2 zijden mogelijk (TYPE LINKS / RECHTS). Het is ook mogelijk tegelijk aan beide kanten lucht met verschillende druk in te laten. Zie onderstaande schema.

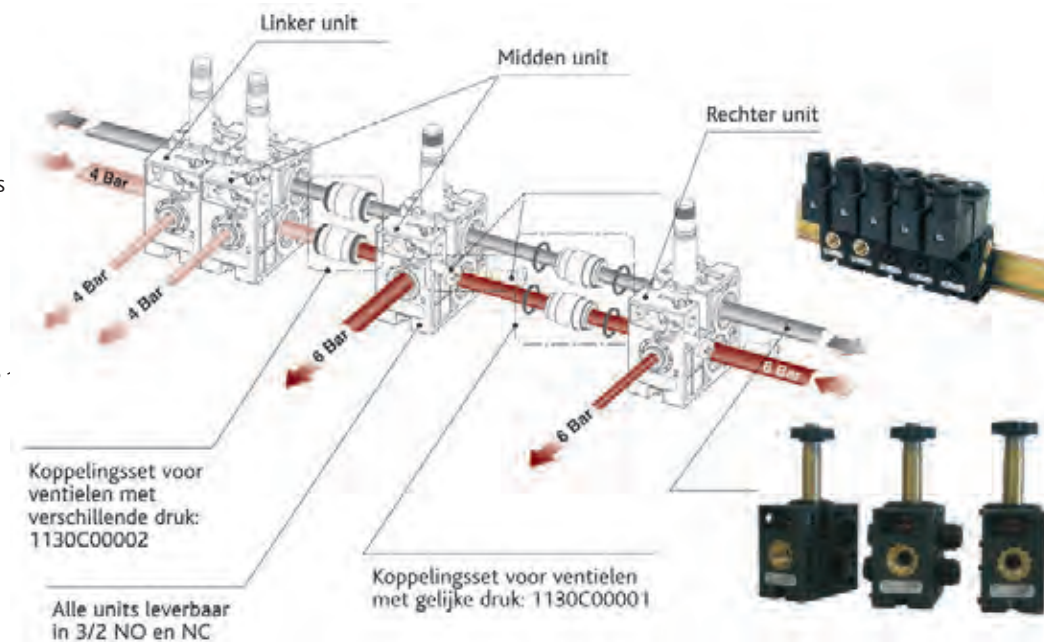

Hoofdstuk 9 – Pneumatiek

KELM™
pneumatiek

Hydrauliek

Snelkoppelingen

Afsluiters

Roestvast staal

Fittingen

Luchtconditionering

Gereedschap

Pneumatiek

Diversen

Malleabele fittingen & staal

Ringleidingssystemen

Slangen

Compressoren

Serie EM110 - 1/8"



3/2 direct werkend magneetventiel -
1/8" BSP female - linker unit - met manual override -
zonder spoel en stekker

3/2 direct werkend magneetventiel -
1/8" BSP female - rechter unit - met manual override -
zonder spoel en stekker

VEN		Functie	Lucht	€
1103023009	AC BAT EM110 3/2 1/8" NC LI Elektrisch - Veer, Links Inlaat		1/8"	21.70
1103023010	AC BAT EM110 3/2 1/8" NO LI Elektrisch - Veer, Links Inlaat		1/8"	30.30
1103023013	AC BAT EM110 3/2 1/8" NC LU Elektrisch - Veer, Links Uitlaat		1/8"	20.65
1103023014	AC BAT EM110 3/2 1/8" NO LU Elektrisch - Veer, Links Uitlaat		1/8"	29.20

VEN		Functie	Lucht	€
1103023011	AC BAT EM110 3/2 1/8" NC RI Elektrisch - Veer - Rechts Inlaat		1/8"	21.70
1103023012	AC BAT EM110 3/2 1/8" NO RI Elektrisch - Veer - Rechts Inlaat		1/8"	30.30
1103023015	AC BAT EM110 3/2 1/8" NC RU Elektrisch - Veer - Rechts Uitlaat		1/8"	20.65
1103023016	AC BAT EM110 3/2 1/8" NO RU Elektrisch - Veer - Rechts Uitlaat		1/8"	29.20

Serie EM110 - 4mm push-in



3/2 direct werkend magneetventiel - 4mm push-in - midden unit - met manual override - zonder spoel en stekker



1103093007 AC BAT EM110 3/2 4mm NC Midden Elektrisch - Veer  4mm Push-in **21.70**

1103093008 AC BAT EM110 3/2 4mm NO Midden Elektrisch - Veer  4mm Push-in **30.55**





3/2 direct werkend magneetventiel - 4mm push-in - linker unit - met manual override - zonder spoel en stekker



1103093009 AC BAT EM110 3/2 4mm NC LI Elektrisch - Veer, Links Inlaat  4mm Push-in **23.00**

1103093010 AC BAT EM110 3/2 4mm NO LI Elektrisch - Veer, Links Inlaat  4mm Push-in **31.45**

1103093013 AC BAT EM110 3/2 4mm NC LU Elektrisch - Veer - Links Uitlaat  4mm Push-in **21.70**

1103093014 AC BAT EM110 3/2 4mm NO LU Elektrisch - Veer - Links Uitlaat  4mm Push-in **30.55**





3/2 direct werkend magneetventiel - 4mm push-in - rechter unit - met manual override - zonder spoel en stekker



1103093011 AC BAT EM110 3/2 4mm NC RI Elektrisch - Veer - Rechts Inlaat  4mm Push-in **23.00**

1103093012 AC BAT EM110 3/2 4mm NO RI Elektrisch - Veer - Rechts Inlaat  4mm Push-in **31.45**

1103093015 AC BAT EM110 3/2 4mm NC RU Elektrisch - Veer - Rechts Uitlaat  4mm Push-in **21.70**

1103093016 AC BAT EM110 3/2 4mm NO RU Elektrisch - Veer - Rechts Uitlaat  4mm Push-in **30.55**

Serie EM110 - 1/8"



3/2 direct werkend magneetventiel - 1/8" BSP female - midden unit - met manual override - zonder spoel en stekker



1103023007 AC BAT EM110 3/2 1/8" NC Midden Elektrisch - Veer  1/8" **20.65**

1103023008 AC BAT EM110 3/2 1/8" NO Midden Elektrisch - Veer  1/8" **29.20**

Serie EM110 - koppeling en bevestiging

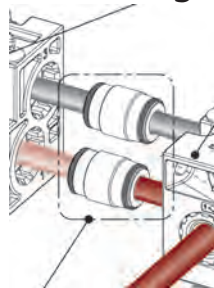

Koppelingskit - voor onderlinge koppeling van ventielen serie EM110



1130C00001 AC Bventiel Koppel Gelijke Druk **1.45**

1130C00002 AC Bventiel Koppel Ongelijke Druk **1.85**



Bevestigingsstuk - voor bevestiging ventielen serie EM110 aan DIN EN50022 (35mm) rails



1130C00003 AC ventielbevestiging V rails **2.75**

KELM™ pneumatiek

Hydrauliek

Snelkoppelingen

Afsluiters

Roestvast staal

Fittingen

Luchtconditionering

Gereedschap

Pneumatiek

Diversen

Malleabele fittingen & staal

Ringleidingssystemen

Slangen

Compressoren

Vlakzuignap type B

Toepassing: Oppakken van gladde en vlakke producten.



Veiligheid: Het opgegeven draagvermogen is de theoretische waarde bij een bedrijfsvacuüm van 60%, zonder veiligheidsfactor.



NBR of siliconen



Type B - NBR

VAZU	H mm	kg	Ø DIA mm	Ø DIA mm	€
ZN3B-NBR	6	0,03	1	3	4.05
ZN6B-NBR	12	0,15	2	6	4.40
ZN10B-NBR	13	0,235	3	10	5.30
ZN16B-NBR	20	0,8	5	16	6.05
ZN25B-NBR	30	1,5	8	25	9.20



Type B - siliconen

VAZU	H mm	kg	Ø DIA mm	Ø DIA mm	€
ZN3B-SIL	6	0,03	1	3	5.55
ZN6B-SIL	12	0,15	2	6	6.80
ZN10B-SIL	13	0,235	3	10	7.80
ZN16B-SIL	20	0,8	5	16	9.55
ZN25B-SIL	30	1,5	8	25	11.60



Adapters voor type B vlakke zuignappen - aluminium

VAZU	To Suit	C	H mm	BSPP	Ø DIA mm	Ø DIA mm	€
BSCN-A1	6B-10B	8	18	1/8"	2	3,5	5.95
BSCN-A2	16B	13	25	1/8"	4,7	9	7.45
BSCN-A3	25B	14	28	1/8"	5	9	8.20

Vlakzuignap type A

Robuuste stijve zuignappen met een relatief klein intern volume.

Toepassing: Oppakken van gladde en vlakke producten.



Veiligheid: Het opgegeven draagvermogen is de theoretische waarde bij een bedrijfsvacuüm van 60%, zonder veiligheidsfactor.



NBR of siliconen



Type A - NBR

VAZU	H mm	kg	Ø DIA mm	Ø DIA mm	€
ZN20A-NBR	15	1,0	4,8	20	3.20
ZN28A-NBR	15	1,8	4,8	28	3.55
ZN38A-NBR	23	3,4	8,0	38	3.90
ZN45A-NBR	26,5	4,8	9,0	45	4.30
ZN60A-NBR	25	7,9	9,0	60	4.90
ZN75A-NBR	38	10	9,0	75	6.35



Type A - siliconen

VAZU	H mm	kg	Ø DIA mm	Ø DIA mm	€
ZN20A-SIL	15	1,0	4,8	20	4.15
ZN28A-SIL	15	1,8	4,8	28	4.60
ZN38A-SIL	23	3,4	8,0	38	5.30
ZN45A-SIL	26,5	4,8	9,0	45	6.35
ZN60A-SIL	25	7,9	9,0	60	7.05
ZN75A-SIL	38	10	9,0	75	10.95

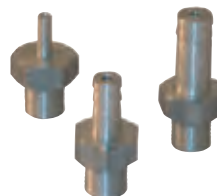

Adapters voor type A vlakke zuignappen - aluminium

VAZU	To Suit	C	H mm	BSPP	Ø DIA mm	Ø DIA mm	€
BSCN-A2	20A-28A	13	25	1/8"	4,7	9	7.45
BSCN-A3	38A-75A	14	28	1/8"	5	9	8.20

Balgzuignap type D

Flexibele constructie met 1,5 vouwen. Hierdoor past de zuignap zich aan het voorwerppoppervlak aan.

Toepassing: Palletiseer- en stapelinrichtingen.



Veiligheid: Het opgegeven draagvermogen is de theoretische waarde bij een bedrijfsvacuüm van 60%, zonder veiligheidsfactor.



NBR of siliconen



Type D - 1,5 vouwen - NBR

VAZU	H mm	kg	DIA mm	DIA mm	€
ZN11D-NBR	16	0,117	5	11	3.10
ZN16D-NBR	19	0,23	5	16	3.20
ZN20D-NBR	16	0,47	5	20	3.35
ZN22D-NBR	19	0,53	5	22	3.40
ZN25D-NBR	23	0,57	5	25	3.55
ZN37D-NBR	27	1,3	8	37	3.55
ZN43D-NBR	27	2,3	8	43	4.75
ZN53D-NBR	33	5,2	8	53	7.65
ZN80D-NBR	46	14	11,8	80	12.70



Type D - 1,5 vouwen - siliconen

VAZU	H mm	kg	DIA mm	DIA mm	€
ZN11D-SIL	16	0,117	5	11	3.25
ZN16D-SIL	19	0,23	5	16	3.40
ZN20D-SIL	16	0,47	5	20	3.55
ZN22D-SIL	19	0,53	5	22	3.70
ZN25D-SIL	23	0,57	5	25	3.80
ZN37D-SIL	27	1,3	8	37	6.35
ZN43D-SIL	27	2,3	8	43	7.45
ZN53D-SIL	33	5,2	8	53	10.25
ZN80D-SIL	46	14	11,8	80	17.00



Adapters voor type D balgzuignappen - aluminium

VAZU	BSPP	To Suit	H mm	DIA mm	€
BSCN-E4	Male 1/4"	37D - 53D	17	32	4 7.45
BSCN-E5	Male 1/4"	78D - 80D	17	38	4 7.45
BSCN-G3	Female 1/8"	37D - 53D	14	30	4 9.00
BSCN-G4	Female 1/4"	37D - 53D	17	31	4 9.20
BSCN-G5	Female 1/4"	78D - 80D	17	38	4 9.20
BSCN-E1	Male 1/8"	11D - 25D	13	24,5	4,5 9.00
BSCN-E3	Male 1/4"	11D - 25D	17	24,5	4,5 9.20
BSCN-P4	Male 1/4"	37D - 53D	17	29,5	1 10.70

Balgzuignap type E

Zeer flexibele constructie met 2,5 vouwen, zorgt voor een uitstekende aanpassing aan het voorwerp. Tevens goede hoogteverschil vereffening.

Toepassing: Palletiseer- en stapelinrichtingen.



Veiligheid: Het opgegeven draagvermogen is de theoretische waarde bij een bedrijfsvacuüm van 60%, zonder veiligheidsfactor.



NBR of siliconen



Type E - 2,5 vouwen - siliconen

VAZU	H mm	kg	DIA mm	€
ZN7E-SIL	14	0,01	7	3.35
ZN9E-SIL	15	0,068	9	3.40
ZN14E-SIL	23	0,11	14	3.55
ZN18E-SIL	23	0,23	18	3.70
ZN20E-SIL	23	0,38	20	3.90
ZN25E-SIL	34	0,45	25	4.15
ZN32E-SIL	37,5	1,2	32	5.05
ZN42E-SIL	46	1,4	42	6.80
ZN62E-SIL	55	3,9	62	9.10
ZN88E-SIL	87,5	4,5	88	17.85



Type E - 2,5 vouwen - NBR

VAZU	H mm	kg	DIA mm	€
ZN14E-NBR	23	0,11	14	3.40
ZN18E-NBR	23	0,23	18	3.65
ZN20E-NBR	23	0,38	20	3.80
ZN25E-NBR	34	0,45	25	3.80
ZN32E-NBR	37,5	1,2	32	4.55
ZN42E-NBR	46	1,4	42	5.30
ZN62E-NBR	55	3,9	62	7.60
ZN88E-NBR	87,5	4,5	88	17.00
ZN7E-NBR	14	0,01	7	3.20
ZN9E-NBR	15	0,068	9	3.25



Adapters voor type E balgzuignappen - aluminium

VAZU	BSPP	To Suit	H mm	DIA mm	€
BSCN-E4	Male 1/4"	32E - 62E	17	32	4 7.45
BSCN-E5	Male 1/4"	88E	17	38	4 7.45
BSCN-G3	Female 1/8"	32E - 62E	14	30	4 9.00
BSCN-G4	Female 1/4"	32E - 62E	17	31	4 9.20
BSCN-G5	Female 1/4"	88E	17	38	4 9.20
BSCN-E1	Male 1/8"	7E - 25E	13	24,5	4,5 9.00
BSCN-E3	Male 1/4"	7E - 25E	17	24,5	4,5 9.20
BSCN-P4	Male 1/4"	32E - 62E	17	29,5	1 10.70

KELM™
pneumatiek

Hydrauliek

Snel-
koppelingen

Afsluiters

Roestvast
staal

Fittingen

Lucht-
conditionering

Gereedschap

Pneumatiek

Diversen

Malleabele
fittings
& staal

Ringleiding-
systemen

Slangen

Compressoren

Balgzuignap type C

Flexibele constructie met 1,5 vouwen. Hierdoor past de zuignap zich aan het voorwerppoppervlak aan. Met 8mm gaten voor drageraansluiting.
Toepassing: Palletiseerinrichtingen en zwaardere werkstukken.



Veiligheid: Het opgegeven draagvermogen is de theoretische waarde bij een bedrijfsvacuüm van 60%, zonder veiligheidsfactor.



NBR of siliconen



Type C - 1,5 vouwen - NBR

VAZU	H mm	kg	DIA mm	€
ZN110C-NBR	58	29	110	42.55
ZN150C-NBR	70	58	150	72.30



Type C - 1,5 vouwen - siliconen

VAZU	H mm	kg	DIA mm	€
ZN110C-SIL	58	29	110	77.90
ZN150C-SIL	70	58	150	135.20

Vlakzuignap type F

Zware industriële zuignap met geprofileerde binnenzijde en 8mm gaten voor drageraansluiting.

Toepassing: Palletiseerinrichtingen en zwaardere werkstukken.



Veiligheid: Het opgegeven draagvermogen is de theoretische waarde bij een bedrijfsvacuüm van 60%, zonder veiligheidsfactor.



NBR of siliconen



Type F - NBR

VAZU	H mm	kg	DIA mm	€
ZN120F-NBR	25,5	51	120	32.60
ZN150F-NBR	32,5	65	150	35.40
ZN200F-NBR	39	141	200	46.70



Type F - siliconen

VAZU	H mm	kg	DIA mm	€
ZN120F-SIL	25,5	51	120	55.30
ZN150F-SIL	32,5	65	150	59.50
ZN200F-SIL	39	141	200	86.40



Drager voor balgzuignap type C en vlakzuignap type F

VAZU	H mm	DIA mm	€	
AD106801	3/8"	13	53	32.30
AD106800	1/2"	13	53	32.30
AD106802	1/4"	13	53	32.30

KELM™ pneumatiek

Hydrauliek

Snelkoppelingen

Afsluiters

Roestvast staal

Fittingen

Luchtconditionering

Gereedschap

Pneumatiek

Diversen

Malleabele fittingen & staal

Ringleidingssystemen

Slangen

Compressoren

Venturi vacuümpomp

Vacuüm creëren met Venturi pompen

Het principe van een Venturi is het omzetten van persluchtdruk in luchtsnelheid. De Venturi creëert vacuüm met als energiebron perslucht.

De luchtstroom gaat door een vernauwing en wordt daarna gecontroleerd geëxpandeerd.

Bij de expansie heeft de luchtstroom de maximale snelheid, daar treedt dan ook de maximale op (vacuüm) met als gevolg dat de atmosferische lucht wordt aangezogen in de Venturi.

Om het maximale rendement te behalen is een optimale binnen geometrie essentieel.



De icoontjes en geven respectievelijk de aansluitingsschroefdraad van de persluchtaanvoer en de vacuümaansluiting aan.

Toepassingen: Machinebouw, pick- en place units, verpakkingsmachines, manipulators, fixatie etc.



Aluminium St-51



50



1/4" BSP



40



28



1/2" BSP

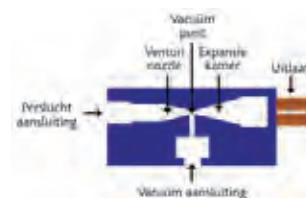

1/2" BSP female vacuümaansluiting

VAZU	ID mm	bar	Lucht L/min	FLOW	Vacuüm bar	€
VENTURI-100-08ZH	0,8	5,5	40	30	-0,9	64.95
VENTURI-100-10ZH	1	4,5	55	40	-0,9	58.15
VENTURI-100-13ZH	1,3	4,5	80	65	-0,9	58.15
VENTURI-100-15ZH	1,5	4,5	135	90	-0,9	58.15
VENTURI-100-17ZH	1,7	4,5	170	110	-0,9	58.15
VENTURI-100-08ZM	0,8	5,5	44	40	-0,6	64.95
VENTURI-100-10ZM	1	5,5	55	60	-0,6	58.15
VENTURI-100-13ZM	1,3	5,5	80	90	-0,6	58.15
VENTURI-100-15ZM	1,5	5,5	130	140	-0,6	58.15

Serie 60 - ISO15552 cilinders - dubbelwerkend - niet-magnetisch

Dubbelwerkend, niet-magnetisch
 Ø 32 - 40 - 50 - 63 - 80 - 100 - 125 mm

- Enkel- en dubbelwerkend verkrijgbaar
- Gerolde RVS zuigerstang
- Instelbare eindbuffering
- NBR / PU pakkingen, Viton op aanvraag
- Low-friction versie mogelijk (-40% wrijving)
- Aluminium geanodiseerde buis en einddeksels
- Gebruikt in alle industrieën (specials op aanvraag)

Medium
 Gefilterde lucht, zonder smering
Snelheid
 10 ÷ 1000 mm/sec Standaard versie (zonder gewicht)
 5 ÷ 1000 mm/sec Low friction versie
Slaglengtes min - max
 10 ÷ 2500 mm
 10 ÷ 0080 mm (enkelwerkend)

Temperatuur:
 0°C ÷ 80°C
 -20°C met droge lucht

Maximale werkdruk:
 1 - 10 bar dubbelwerkend

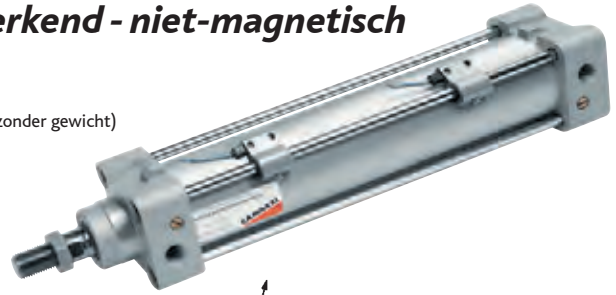

Symbolen
 Enkelwerkend

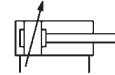

Dubbelwerkend

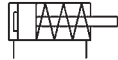

Ø 32 mm - G1/8"

0158	Ø mm	mm		€
60N2L032A0025	32	25	G1/8"	66.70
60N2L032A0050	32	50	G1/8"	67.50
60N2L032A0075	32	75	G1/8"	68.70
60N2L032A0080	32	80	G1/8"	68.70
60N2L032A0100	32	100	G1/8"	69.50
60N2L032A0125	32	125	G1/8"	69.80
60N2L032A0150	32	150	G1/8"	70.85
60N2L032A0160	32	160	G1/8"	71.25
60N2L032A0200	32	200	G1/8"	72.30
60N2L032A0250	32	250	G1/8"	74.50
60N2L032A0300	32	300	G1/8"	76.75
60N2L032A0320	32	320	G1/8"	77.70
60N2L032A0400	32	400	G1/8"	83.45
60N2L032A0500	32	500	G1/8"	88.05
60N2L032A0600	32	600	G1/8"	92.65
60N2L032A0700	32	700	G1/8"	97.25
60N2L032A0800	32	800	G1/8"	101.90
60N2L032A0900	32	900	G1/8"	106.50
60N2L032A1000	32	1000	G1/8"	111.10
60N2L032A1250	32	1250	G1/8"	130.55
60N2L032A1500	32	1500	G1/8"	142.75
60N2L032A1750	32	1750	G1/8"	155.05
60N2L032A2000	32	2000	G1/8"	167.25

Ø 40 mm - G1/4"

0158	Ø mm	mm		€
60N2L040A0025	40	25	G1/4"	78.65
60N2L040A0050	40	50	G1/4"	80.05
60N2L040A0075	40	75	G1/4"	80.75
60N2L040A0080	40	80	G1/4"	80.75
60N2L040A0100	40	100	G1/4"	82.20
60N2L040A0125	40	125	G1/4"	82.90
60N2L040A0150	40	150	G1/4"	84.35
60N2L040A0160	40	160	G1/4"	85.00
60N2L040A0200	40	200	G1/4"	87.20
60N2L040A0250	40	250	G1/4"	89.35
60N2L040A0300	40	300	G1/4"	92.55
60N2L040A0320	40	320	G1/4"	93.80
60N2L040A0400	40	400	G1/4"	99.50
60N2L040A0500	40	500	G1/4"	105.75
60N2L040A0600	40	600	G1/4"	112.15
60N2L040A0700	40	700	G1/4"	118.25
60N2L040A0800	40	800	G1/4"	124.60
60N2L040A0900	40	900	G1/4"	131.00
60N2L040A1000	40	1000	G1/4"	137.35
60N2L040A1250	40	1250	G1/4"	154.40
60N2L040A1500	40	1500	G1/4"	170.40
60N2L040A1750	40	1750	G1/4"	186.10
60N2L040A2000	40	2000	G1/4"	203.00

Ø 50 mm - G1/4"

0158	Ø mm	mm		€
60N2L050A0025	50	25	G1/4"	91.65
60N2L050A0050	50	50	G1/4"	93.65
60N2L050A0075	50	75	G1/4"	95.45
60N2L050A0080	50	80	G1/4"	95.45
60N2L050A0100	50	100	G1/4"	97.20
60N2L050A0125	50	125	G1/4"	99.15
60N2L050A0150	50	150	G1/4"	100.85
60N2L050A0160	50	160	G1/4"	101.85
60N2L050A0200	50	200	G1/4"	105.05
60N2L050A0250	50	250	G1/4"	107.20
60N2L050A0300	50	300	G1/4"	111.05
60N2L050A0320	50	320	G1/4"	112.75
60N2L050A0400	50	400	G1/4"	120.00
60N2L050A0500	50	500	G1/4"	126.90
60N2L050A0600	50	600	G1/4"	134.90
60N2L050A0700	50	700	G1/4"	142.85
60N2L050A0800	50	800	G1/4"	151.05
60N2L050A0900	50	900	G1/4"	158.85
60N2L050A1000	50	1000	G1/4"	166.90
60N2L050A1250	50	1250	G1/4"	187.30
60N2L050A1500	50	1500	G1/4"	207.60
60N2L050A1750	50	1750	G1/4"	227.30
60N2L050A2000	50	2000	G1/4"	247.65

Ø 63 mm - G3/8"

0158	Ø mm	mm		€
60N2L063A0025	63	25	G3/8"	107.95
60N2L063A0050	63	50	G3/8"	110.80
60N2L063A0075	63	75	G3/8"	112.25
60N2L063A0080	63	80	G3/8"	112.25
60N2L063A0100	63	100	G3/8"	113.65
60N2L063A0125	63	125	G3/8"	115.80
60N2L063A0150	63	150	G3/8"	117.25
60N2L063A0160	63	160	G3/8"	117.90
60N2L063A0200	63	200	G3/8"	120.05
60N2L063A0250	63	250	G3/8"	123.65
60N2L063A0300	63	300	G3/8"	129.15
60N2L063A0320	63	320	G3/8"	131.00
60N2L063A0400	63	400	G3/8"	137.50
60N2L063A0500	63	500	G3/8"	146.70
60N2L063A0600	63	600	G3/8"	155.90
60N2L063A0700	63	700	G3/8"	165.00
60N2L063A0800	63	800	G3/8"	174.25
60N2L063A0900	63	900	G3/8"	183.30
60N2L063A1000	63	1000	G3/8"	192.25
60N2L063A1250	63	1250	G3/8"	215.65
60N2L063A1500	63	1500	G3/8"	238.70
60N2L063A1750	63	1750	G3/8"	261.45
60N2L063A2000	63	2000	G3/8"	284.55

KELM™ pneumatiek

Hydrauliek

Snelkoppelingen

Afsluiters

Roestvast staal

Fittingen

Luchtconditionering

Gereedschap

Pneumatiek

Diversen

Malleabele fittingen & staal

Ringleidingssystemen

Slangen

Compressoren

Serie 60 - ISO15552 cilinders - dubbelwerkend - niet-magnetisch



Ø 80 mm - G3/8"

0158	Ø mm	↔ mm	🌀	€
60N2L080A0025	80	25	G3/8"	150.10
60N2L080A0050	80	50	G3/8"	152.20
60N2L080A0075	80	75	G3/8"	155.15
60N2L080A0080	80	80	G3/8"	155.15
60N2L080A0100	80	100	G3/8"	157.30
60N2L080A0125	80	125	G3/8"	160.15
60N2L080A0150	80	150	G3/8"	162.95
60N2L080A0160	80	160	G3/8"	163.70
60N2L080A0200	80	200	G3/8"	167.95
60N2L080A0250	80	250	G3/8"	173.95
60N2L080A0300	80	300	G3/8"	180.75
60N2L080A0320	80	320	G3/8"	183.30
60N2L080A0400	80	400	G3/8"	196.70
60N2L080A0500	80	500	G3/8"	210.20
60N2L080A0600	80	600	G3/8"	223.90
60N2L080A0700	80	700	G3/8"	237.45
60N2L080A0800	80	800	G3/8"	251.15
60N2L080A0900	80	900	G3/8"	264.85
60N2L080A1000	80	1000	G3/8"	276.80
60N2L080A1250	80	1250	G3/8"	307.30
60N2L080A1500	80	1500	G3/8"	341.10
60N2L080A1750	80	1750	G3/8"	373.70
60N2L080A2000	80	2000	G3/8"	407.55

Ø 125 mm - G1/2"

0158	Ø mm	↔ mm	🌀	€
60N2L125A0025	125	25	G1/2"	288.55
60N2L125A0050	125	50	G1/2"	293.60
60N2L125A0075	125	75	G1/2"	299.30
60N2L125A0080	125	80	G1/2"	299.30
60N2L125A0100	125	100	G1/2"	303.70
60N2L125A0125	125	125	G1/2"	308.85
60N2L125A0150	125	150	G1/2"	313.75
60N2L125A0160	125	160	G1/2"	315.75
60N2L125A0200	125	200	G1/2"	324.80
60N2L125A0250	125	250	G1/2"	339.90
60N2L125A0300	125	300	G1/2"	355.55
60N2L125A0320	125	320	G1/2"	364.50
60N2L125A0400	125	400	G1/2"	391.90
60N2L125A0500	125	500	G1/2"	414.50
60N2L125A0600	125	600	G1/2"	436.75
60N2L125A0700	125	700	G1/2"	459.85
60N2L125A0800	125	800	G1/2"	479.85
60N2L125A0900	125	900	G1/2"	501.35
60N2L125A1000	125	1000	G1/2"	522.90
60N2L125A1250	125	1250	G1/2"	578.30
60N2L125A1500	125	1500	G1/2"	633.65
60N2L125A1750	125	1750	G1/2"	687.50
60N2L125A2000	125	2000	G1/2"	741.35

Ø 100 mm - G1/2"

0158	Ø mm	↔ mm	🌀	€
60N2L100A0025	100	25	G1/2"	187.25
60N2L100A0050	100	50	G1/2"	189.40
60N2L100A0075	100	75	G1/2"	192.70
60N2L100A0080	100	80	G1/2"	192.70
60N2L100A0100	100	100	G1/2"	195.15
60N2L100A0125	100	125	G1/2"	198.00
60N2L100A0150	100	150	G1/2"	200.20
60N2L100A0160	100	160	G1/2"	201.60
60N2L100A0200	100	200	G1/2"	205.90
60N2L100A0250	100	250	G1/2"	212.25
60N2L100A0300	100	300	G1/2"	218.05
60N2L100A0320	100	320	G1/2"	221.00
60N2L100A0400	100	400	G1/2"	233.20
60N2L100A0500	100	500	G1/2"	246.25
60N2L100A0600	100	600	G1/2"	262.65
60N2L100A0700	100	700	G1/2"	276.80
60N2L100A0800	100	800	G1/2"	293.45
60N2L100A0900	100	900	G1/2"	307.30
60N2L100A1000	100	1000	G1/2"	322.20
60N2L100A1250	100	1250	G1/2"	361.10
60N2L100A1500	100	1500	G1/2"	399.15
60N2L100A1750	100	1750	G1/2"	436.50
60N2L100A2000	100	2000	G1/2"	473.70

Serie 61 - ISO15552 profielcilinders - dubbelwerkend - magnetisch

Dubbelwerkend - magnetisch
Clean Design - Profielcilinder
Ø 32 - 40 - 50 - 63 - 80 - 100 - 125 mm

- Enkel- en dubbelwerkend verkrijgbaar
- Gerolde RVS zuigerstang
- Instelbare eindbuffering
- NBR / PU pakkingen, Viton op aanvraag
- Low-friction versie mogelijk (-40% wrijving)
- Aluminium geanodiseerde buis en einddeksels
- Gebruikt in alle industrieën (specials op aanvraag)
- Reedcontacten direct te verwerken in profiel

Medium
Gefilterde lucht, zonder smering
Snelheid
10 ÷ 1000 mm/sec Standaard versie (zonder gewicht)
5 ÷ 1000 mm/sec Low friction versie
Slaglengtes min - max
10 ÷ 2500 mm
10 ÷ 0080 mm (enkelwerkend)

Temperatuur:
0°C ÷ 80°C
-20°C met droge lucht

Maximale werkdruk:
1 - 10 bar dubbelwerkend



Clean Design

Symbolen
Enkelwerkend

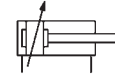

Dubbelwerkend

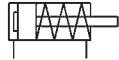

Ø 32 mm - G1/8"

0158	Ø mm	mm		€
61M2P032A0025	32	25	G1/8"	73.85
61M2P032A0050	32	50	G1/8"	76.40
61M2P032A0075	32	75	G1/8"	79.05
61M2P032A0080	32	80	G1/8"	79.70
61M2P032A0100	32	100	G1/8"	81.60
61M2P032A0125	32	125	G1/8"	84.25
61M2P032A0150	32	150	G1/8"	86.15
61M2P032A0160	32	160	G1/8"	87.50
61M2P032A0200	32	200	G1/8"	88.40
61M2P032A0250	32	250	G1/8"	92.80
61M2P032A0300	32	300	G1/8"	96.90
61M2P032A0320	32	320	G1/8"	98.45
61M2P032A0400	32	400	G1/8"	103.85
61M2P032A0500	32	500	G1/8"	109.95
61M2P032A0600	32	600	G1/8"	116.85
61M2P032A0700	32	700	G1/8"	125.35
61M2P032A0800	32	800	G1/8"	133.80
61M2P032A0900	32	900	G1/8"	141.50
61M2P032A1000	32	1000	G1/8"	149.20
61M2P032A1250	32	1250	G1/8"	172.25
61M2P032A1500	32	1500	G1/8"	194.55
61M2P032A1750	32	1750	G1/8"	214.40
61M2P032A2000	32	2000	G1/8"	236.85

Ø 40 mm - G1/4"

0158	Ø mm	mm		€
61M2P040A0025	40	25	G1/4"	90.45
61M2P040A0050	40	50	G1/4"	93.40
61M2P040A0075	40	75	G1/4"	94.50
61M2P040A0080	40	80	G1/4"	95.20
61M2P040A0100	40	100	G1/4"	97.05
61M2P040A0125	40	125	G1/4"	98.00
61M2P040A0150	40	150	G1/4"	101.35
61M2P040A0160	40	160	G1/4"	102.10
61M2P040A0200	40	200	G1/4"	104.35
61M2P040A0250	40	250	G1/4"	108.00
61M2P040A0300	40	300	G1/4"	113.45
61M2P040A0320	40	320	G1/4"	115.95
61M2P040A0400	40	400	G1/4"	125.20
61M2P040A0500	40	500	G1/4"	133.80
61M2P040A0600	40	600	G1/4"	145.35
61M2P040A0700	40	700	G1/4"	155.30
61M2P040A0800	40	800	G1/4"	165.35
61M2P040A0900	40	900	G1/4"	174.55
61M2P040A1000	40	1000	G1/4"	182.25
61M2P040A1250	40	1250	G1/4"	206.05
61M2P040A1500	40	1500	G1/4"	233.00
61M2P040A1750	40	1750	G1/4"	256.70
61M2P040A2000	40	2000	G1/4"	280.75

Ø 50 mm - G1/4"

0158	Ø mm	mm		€
61M2P050A0025	50	25	G1/4"	103.10
61M2P050A0050	50	50	G1/4"	104.85
61M2P050A0075	50	75	G1/4"	109.00
61M2P050A0080	50	80	G1/4"	109.65
61M2P050A0100	50	100	G1/4"	113.10
61M2P050A0125	50	125	G1/4"	117.90
61M2P050A0150	50	150	G1/4"	122.05
61M2P050A0160	50	160	G1/4"	123.45
61M2P050A0200	50	200	G1/4"	125.85
61M2P050A0250	50	250	G1/4"	134.90
61M2P050A0300	50	300	G1/4"	138.70
61M2P050A0320	50	320	G1/4"	141.15
61M2P050A0400	50	400	G1/4"	150.65
61M2P050A0500	50	500	G1/4"	159.95
61M2P050A0600	50	600	G1/4"	172.25
61M2P050A0700	50	700	G1/4"	186.10
61M2P050A0800	50	800	G1/4"	199.15
61M2P050A0900	50	900	G1/4"	210.75
61M2P050A1000	50	1000	G1/4"	219.90
61M2P050A1250	50	1250	G1/4"	250.65
61M2P050A1500	50	1500	G1/4"	281.45
61M2P050A1750	50	1750	G1/4"	312.15
61M2P050A2000	50	2000	G1/4"	342.95

Ø 63 mm - G3/8"

0158	Ø mm	mm		€
61M2P063A0025	63	25	G3/8"	123.60
61M2P063A0050	63	50	G3/8"	128.75
61M2P063A0075	63	75	G3/8"	134.60
61M2P063A0080	63	80	G3/8"	135.35
61M2P063A0100	63	100	G3/8"	139.70
61M2P063A0125	63	125	G3/8"	141.40
61M2P063A0150	63	150	G3/8"	146.40
61M2P063A0160	63	160	G3/8"	148.50
61M2P063A0200	63	200	G3/8"	152.40
61M2P063A0250	63	250	G3/8"	157.85
61M2P063A0300	63	300	G3/8"	164.25
61M2P063A0320	63	320	G3/8"	165.85
61M2P063A0400	63	400	G3/8"	175.60
61M2P063A0500	63	500	G3/8"	191.85
61M2P063A0600	63	600	G3/8"	207.70
61M2P063A0700	63	700	G3/8"	221.50
61M2P063A0800	63	800	G3/8"	234.50
61M2P063A0900	63	900	G3/8"	246.85
61M2P063A1000	63	1000	G3/8"	259.15
61M2P063A1250	63	1250	G3/8"	296.85
61M2P063A1500	63	1500	G3/8"	332.25
61M2P063A1750	63	1750	G3/8"	366.00
61M2P063A2000	63	2000	G3/8"	398.30

KELM™
pneumatiek

Hydrauliek

Snel-
koppelingen

Afsluiters

Roestvast
staal

Fittingen

Lucht-
conditionering

Gereedschap

Pneumatiek

Diversen

Malleabele
fittingen
& staal

Ringleiding-
systemen

Slangen

Compressoren

Serie 61 - ISO15552 profielcilinders - dubbelwerkend - magnetisch



Clean Design



Ø 80 mm - G3/8"

0158	Ø mm	mm		€
61M2P080A0025	80	25	G3/8"	175.45
61M2P080A0050	80	50	G3/8"	179.20
61M2P080A0075	80	75	G3/8"	182.95
61M2P080A0080	80	80	G3/8"	183.65
61M2P080A0100	80	100	G3/8"	186.65
61M2P080A0125	80	125	G3/8"	190.35
61M2P080A0150	80	150	G3/8"	194.90
61M2P080A0160	80	160	G3/8"	196.40
61M2P080A0200	80	200	G3/8"	202.35
61M2P080A0250	80	250	G3/8"	209.75
61M2P080A0300	80	300	G3/8"	217.25
61M2P080A0320	80	320	G3/8"	221.00
61M2P080A0400	80	400	G3/8"	232.95
61M2P080A0500	80	500	G3/8"	248.60
61M2P080A0600	80	600	G3/8"	278.50
61M2P080A0700	80	700	G3/8"	293.45
61M2P080A0800	80	800	G3/8"	308.35
61M2P080A0900	80	900	G3/8"	324.00
61M2P080A1000	80	1000	G3/8"	339.75
61M2P080A1250	80	1250	G3/8"	409.85
61M2P080A1500	80	1500	G3/8"	448.80
61M2P080A1750	80	1750	G3/8"	486.90
61M2P080A2000	80	2000	G3/8"	525.85

Ø 100 mm - G1/2"

0158	Ø mm	mm		€
61M2P100A0025	100	25	G1/2"	221.75
61M2P100A0050	100	50	G1/2"	227.00
61M2P100A0075	100	75	G1/2"	232.20
61M2P100A0080	100	80	G1/2"	232.95
61M2P100A0100	100	100	G1/2"	237.45
61M2P100A0125	100	125	G1/2"	242.65
61M2P100A0150	100	150	G1/2"	247.10
61M2P100A0160	100	160	G1/2"	249.40
61M2P100A0200	100	200	G1/2"	256.85
61M2P100A0250	100	250	G1/2"	267.30
61M2P100A0300	100	300	G1/2"	277.00
61M2P100A0320	100	320	G1/2"	280.75
61M2P100A0400	100	400	G1/2"	297.20
61M2P100A0500	100	500	G1/2"	317.30
61M2P100A0600	100	600	G1/2"	354.65
61M2P100A0700	100	700	G1/2"	374.00
61M2P100A0800	100	800	G1/2"	394.20
61M2P100A0900	100	900	G1/2"	413.65
61M2P100A1000	100	1000	G1/2"	433.75
61M2P100A1250	100	1250	G1/2"	521.15
61M2P100A1500	100	1500	G1/2"	571.25
61M2P100A1750	100	1750	G1/2"	620.45
61M2P100A2000	100	2000	G1/2"	669.75

Ø 125 mm - G1/2"

0158	Ø mm	mm		€
61M2P125A0025	125	25	G1/2"	340.50
61M2P125A0050	125	50	G1/2"	348.00
61M2P125A0075	125	75	G1/2"	355.40
61M2P125A0080	125	80	G1/2"	356.90
61M2P125A0100	125	100	G1/2"	362.15
61M2P125A0125	125	125	G1/2"	368.80
61M2P125A0150	125	150	G1/2"	377.05
61M2P125A0160	125	160	G1/2"	380.00
61M2P125A0200	125	200	G1/2"	391.25
61M2P125A0250	125	250	G1/2"	443.50
61M2P125A0300	125	300	G1/2"	459.20
61M2P125A0320	125	320	G1/2"	465.15
61M2P125A0400	125	400	G1/2"	490.55
61M2P125A0500	125	500	G1/2"	521.90
61M2P125A0600	125	600	G1/2"	554.05
61M2P125A0700	125	700	G1/2"	585.40
61M2P125A0800	125	800	G1/2"	617.50
61M2P125A0900	125	900	G1/2"	648.10
61M2P125A1000	125	1000	G1/2"	680.95
61M2P125A1250	125	1250	G1/2"	760.15
61M2P125A1500	125	1500	G1/2"	791.75
61M2P125A1750	125	1750	G1/2"	917.70
61M2P125A2000	125	2000	G1/2"	996.75

Serie 60 en 61 - bevestigingen



Voet / hoekbevestigingssteun - model B

0158	Ø mm	€
B 41 32	32	9.35
B 41 40	40	10.75
B 41 50	50	11.95
B 41 63	63	15.30
B 41 80	80	18.25
B 41 100	100	26.80
B 41 125	125	57.15



Front / achterflens - model D-E

0158	Ø mm	€
D E 41 32	32	10.75
D E 41 40	40	11.85
D E 41 50	50	14.50
D E 41 63	63	17.15
D E 41 80	80	24.70
D E 41 100	100	32.30
D E 41 125	125	49.65



Dubbelwangig achterscharnier - model C en CH

0158	Ø mm	€
C 41 32	32	12.15
C 41 40	40	13.65
C 41 50	50	16.80
CH 41 63	63	19.95
CH 41 80	80	26.15
CH 41 100	100	36.50
CH 41 125	125	61.95



Enkelwangig achterscharnier - model L

0158	Ø mm	€
L 41 32	32	12.15
L 41 40	40	13.65
L 41 50	50	18.25
L 41 63	63	21.40
L 41 80	80	27.35
L 41 100	100	39.05
L 41 125	125	58.80



Pen voor dubbelwangig achterscharnier - model S

0158	Ø mm	€
S 32	32	5.90
S 40	40	3.90
S 50	50	4.00
S 63	63	5.30
S 80	80	6.65
S 100	100	8.35
S 125	125	11.70



Kogelstangkop - model GA

0158	Ø mm	€
GA 25-32	32	22.55
GA 40	40	27.65
GA 50-63	50 - 63	57.55
GA 80-100	80 - 100	74.60
GA 41 125	125	135.80



Vork met pen - model G

0158	Ø mm	€
G 25-32	32	3.90
G 40	40	6.35
G 50-63	50 - 63	12.95
G 80-100	80 - 100	23.55
G 41 125	125	52.40



Moer t.b.v. zuigerstang - model U

0158	Ø mm	€
U 25/32	32	0.45
U 40	40	0.65
U 50/63	50 - 63	1.10
U 80/100	80 - 100	1.80
U 41 125	125	3.00

Serie 60 en 61 - benaderingsschakelaars CST

Kabel 2 meter

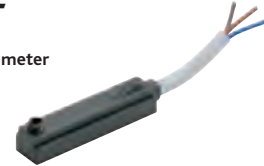

Benaderingsschakelaar (serie 60 met beugel - serie 61 direct in profiel van cilinder)

0158			€
CST 220	3 draads	10-110V AC/DC	18.45
CST 232	2 draads	5-30V AC/DC	21.20
CST 332	Hall effect, 3 draadig, PNP	27V DC	28.10



Benaderingsschakelaar M8 (serie 60 met beugel - serie 61 direct in profiel van cilinder)

0158			€
CST 262	3 draads	5-30V AC/DC	30.45
CST 362	Hall effect, 3 draads, PNP	27V DC	36.90



Bevestigingsbeugel serie 60

0158	Ø mm	€
S-CST 25	32 - 63	5.05
S-CST 26	80 - 100	5.40
S-CST 27	125	12.30

KELM™ pneumatiek

Hydrauliek

Snelkoppelingen

Afsluiters

Roestvast staal

Fittingen

Luchtconditionering

Gereedschap

Pneumatiek

Diversen

Malleabele fittingen & staal

Ringleidingssystemen

Slangen

Compressoren

Serie 24 - ISO6432 minicilinders - dubbelwerkend - magnetisch

Dubbelwerkend - magnetisch

Ø 16 - 20 - 25

- Enkel- en dubbelwerkend verkrijgbaar
- Roestvaststalen buis en zuigerstang
- Aluminium geanodiseerde einddeksels
- Standaard magneetzuiger
- Speciaal voor hoge snelheden
- Gebruikt in alle industrieën

Medium

Gefilterde lucht, zonder smering

Snelheid

10 ÷ 1000 mm/sec (zonder gewicht)



Temperatuur:

0°C ÷ 80°C

-20°C met droge lucht



Maximale werkdruk:

2 - 10 bar enkelwerkend

0 - 10 bar dubbelwerkend



Symbolen

Enkelwerkend,
neusveer, ongebufferd



Dubbelwerkend,
ongebufferd



Ø 16 mm - M5

0158	Ø mm	mm		€
24NZA16A010	16	10	M5	34.55
24NZA16A025	16	25	M5	35.40
24NZA16A040	16	40	M5	35.95
24NZA16A050	16	50	M5	36.85
24NZA16A080	16	80	M5	38.25
24NZA16A100	16	100	M5	38.75
24NZA16A125	16	125	M5	39.55
24NZA16A160	16	160	M5	41.70
24NZA16A200	16	200	M5	42.85
24NZA16A250	16	250	M5	48.50
24NZA16A300	16	300	M5	50.85
24NZA16A320	16	320	M5	53.20
24NZA16A400	16	400	M5	56.35
24NZA16A500	16	500	M5	61.95

Ø 20 mm - G1/8"

0158	Ø mm	mm		€
24NZA20A010	20	10	G1/8"	35.95
24NZA20A025	20	25	G1/8"	36.85
24NZA20A040	20	40	G1/8"	37.40
24NZA20A050	20	50	G1/8"	38.25
24NZA20A080	20	80	G1/8"	40.50
24NZA20A100	20	100	G1/8"	41.70
24NZA20A125	20	125	G1/8"	42.50
24NZA20A160	20	160	G1/8"	43.70
24NZA20A200	20	200	G1/8"	46.45
24NZA20A250	20	250	G1/8"	49.65
24NZA20A300	20	300	G1/8"	52.80
24NZA20A320	20	320	G1/8"	54.40
24NZA20A400	20	400	G1/8"	58.35
24NZA20A500	20	500	G1/8"	64.25

Ø 25 mm - G1/8"

0158	Ø mm	mm		€
24NZA25A010	25	10	G1/8"	40.50
24NZA25A025	25	25	G1/8"	40.90
24NZA25A040	25	40	G1/8"	41.70
24NZA25A050	25	50	G1/8"	42.50
24NZA25A080	25	80	G1/8"	43.70
24NZA25A100	25	100	G1/8"	44.50
24NZA25A125	25	125	G1/8"	46.45
24NZA25A160	25	160	G1/8"	48.85
24NZA25A200	25	200	G1/8"	52.05
24NZA25A250	25	250	G1/8"	55.55
24NZA25A300	25	300	G1/8"	58.80
24NZA25A320	25	320	G1/8"	59.95
24NZA25A400	25	400	G1/8"	65.55
24NZA25A500	25	500	G1/8"	70.65

KELM™
pneumatiek

Hydrauliek

Snel-
koppelingen

Afsluiters

Roestvast
staal

Fittingen

Lucht-
conditionering

Gereedschap

Pneumatiek

Diversen

Malleabele
fittingen
& staal

Ringleiding-
systemen

Slangen

Compressoren

Serie 25 - ISO6432 minicilinders - dubbelwerkend - magnetisch

Dubbelwerkend - magnetisch

Ø 16 - 20 - 25

- Instelbare eindbuffering
- Roestvaststalen buis en zuigerstang
- Aluminium geanodiseerde einddeksels
- Standaard magneetzuiger
- Speciaal voor hoge snelheden
- Gebruikt in alle industrieën

Medium

Gefilterde lucht, zonder smering

Snelheid

10 ÷ 1000 mm/sec (zonder gewicht)



Temperatuur:

0°C ÷ 80°C

-20°C met droge lucht



Maximale werkdruk:

2 - 10 bar enkelwerkend

0 - 10 bar dubbelwerkend



Symbolen
Dubbelwerkend,
gebufferd

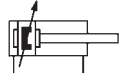

Ø 16 mm - M5

0158	Ø mm	mm	mm	€
25N2A16A010	16	10	G1/8"	56.00
25N2A16A025	16	25	G1/8"	56.00
25N2A16A040	16	40	G1/8"	56.00
25N2A16A050	16	50	G1/8"	56.80
25N2A16A080	16	80	G1/8"	57.95
25N2A16A100	16	100	G1/8"	58.80
25N2A16A125	16	125	G1/8"	59.95
25N2A16A160	16	160	G1/8"	61.55
25N2A16A200	16	200	G1/8"	62.30
25N2A16A250	16	250	G1/8"	63.55
25N2A16A300	16	300	G1/8"	65.90
25N2A16A320	16	320	G1/8"	67.50
25N2A16A400	16	400	G1/8"	73.50
25N2A16A500	16	500	G1/8"	78.20

Ø 20 mm - G1/8"

0158	Ø mm	mm	mm	€
25N2A20A010	20	10	G1/8"	57.95
25N2A20A025	20	25	G1/8"	57.95
25N2A20A040	20	40	G1/8"	58.80
25N2A20A050	20	50	G1/8"	59.95
25N2A20A080	20	80	G1/8"	61.55
25N2A20A100	20	100	G1/8"	62.30
25N2A20A125	20	125	G1/8"	63.55
25N2A20A160	20	160	G1/8"	64.70
25N2A20A200	20	200	G1/8"	65.55
25N2A20A250	20	250	G1/8"	66.70
25N2A20A300	20	300	G1/8"	68.70
25N2A20A320	20	320	G1/8"	70.65
25N2A20A400	20	400	G1/8"	75.85
25N2A20A500	20	500	G1/8"	78.20

Ø 25 mm - G1/8"

0158	Ø mm	mm	mm	€
25N2A25A010	25	10	G1/8"	63.35
25N2A25A025	25	25	G1/8"	63.35
25N2A25A040	25	40	G1/8"	64.70
25N2A25A050	25	50	G1/8"	65.55
25N2A25A080	25	80	G1/8"	66.70
25N2A25A100	25	100	G1/8"	67.50
25N2A25A125	25	125	G1/8"	68.70
25N2A25A160	25	160	G1/8"	69.50
25N2A25A200	25	200	G1/8"	70.65
25N2A25A250	25	250	G1/8"	71.90
25N2A25A300	25	300	G1/8"	73.10
25N2A25A320	25	320	G1/8"	73.85
25N2A25A400	25	400	G1/8"	76.20
25N2A25A500	25	500	G1/8"	78.65

KELM™
pneumatiek

Hydrauliek

Snel-
koppelingen

Afsluiters

Roestvast
staal

Fittingen

Lucht-
conditionering

Gereedschap

Pneumatiek

Diversen

Malleabele
fittingen
& staal

Ringleiding-
systemen

Slangen

Compressoren

Serie 24 en 25 - bevestigingen



90° scharniersteun met pen - model I

I-12-16	12 - 16	4.95
I-20-25	20 - 25	6.55



Vork met pen - model G

G-12-16	12 - 16	2.65
G-20	20	3.05
G-25-32	25 - 32	3.90



Kogelstangkop - model GA

GA-12-16	12 - 16	15.95
GA 20	20	17.50
GA 25-32	25	22.55

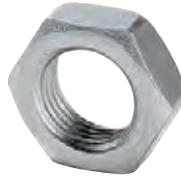

Moer t.b.v. zuigerstang - model U

U-12-16	12 - 16	0.25



Hoekbeugel (set 2 stuks) - model B

B-12-16	12 - 16	5.60
B-20-25	20 - 25	6.35



Bevestigingsflens - model E

E-12-16	12 - 16	1.80
E-20-25	20 - 25	2.20

Serie 24 en 25 - benaderingsschakelaars CST

Kabel 2 meter

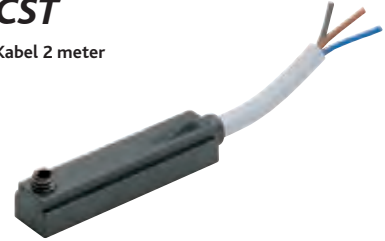

Benaderingsschakelaar

			Output	
CST-220	2 draads	10-110V AC/DC	-	18.45
CST-232	3 draads	5-30V AC/DC	PNP	21.20
CST-332	3 draads, Hall effect	27V DC	PNP	28.10

Benaderingsschakelaar

			Output	
CST-250N	2 draads, M8 stekker	10-110V AC/DC	-	28.10
CST-262	3 draads, M8 stekker	5-30V AC/DC	PNP	30.45
CST-362	3 draads, M8 stekker, Hall effect	27V DC	PNP	36.90



Montagebeugel

S-CST 02	Ø 16 mm	1.50
S-CST 03	Ø 20 mm	1.50
S-CST 04	Ø 25 mm	1.55
CS-5	Verlengkabel 5 meter, M8 stekker	15.35

Serie A - direct werkende magneetventielen

Werking 2/2 - 3/2 NC en NO
Aansluiting M5, G1/8" en Ø 4mm cartridge

Temperatuur:
0°C ÷ 60°C
-20°C met droge lucht

Medium
Gefilterde lucht, zonder smering



Maximale werkdruk:
-0,9 ÷ 15 bar

Magneetventiel 2/2 NC - M5
Flow 60 NL/min, Orifice 1.5mm

0158				
A321 0C2	Valve only	M5	M5	32.05
A321 0C2 U72	12V DC 5W	M5	M5	43.45
A321 0C2 U73	24V DC 5W	M5	M5	43.45
A321 0C2 U79	48V DC 3,1W	M5	M5	43.45
A321 0C2 U710	110V DC 3,1W	M5	M5	43.45
A321 0C2 U7H	12V DC 3,1W 24V AC 3,5VA	M5	M5	43.45
A321 0C2 U7K	110V AC 3,8VA 125V AC 5,5VA	M5	M5	43.45
A321 0C2 U7J	230V AC 3,5VA 240V AC 4VA	M5	M5	43.45

Maximale werkdruk:
-0,9 ÷ 10 bar

Magneetventiel 2/2 NO - M5
Flow 140 NL/min, Orifice 1.8mm

0158				
A322 0C2	Valve only	M5	M5	30.70
A322 0C2 U72	12V DC 5W	M5	M5	42.10
A322 0C2 U73	24V DC 5W	M5	M5	42.10
A322 0C2 U79	48V DC 3,1W	M5	M5	42.10
A322 0C2 U710	110V DC 3,1W	M5	M5	42.10
A322 0C2 U7H	12V DC 3,1W 24V AC 3,5VA	M5	M5	42.10
A322 0C2 U7K	110V AC 3,8VA 125V AC 5,5VA	M5	M5	42.10
A322 0C2 U7J	230V AC 3,5VA 240V AC 4VA	M5	M5	42.10

Maximale werkdruk:
-0,9 ÷ 15 bar

Magneetventiel 2/2 NC - G1/8"
Flow 60 NL/min, Orifice 1.5mm

0158				
A321 1C2	Valve only	G1/8"	G1/8"	31.25
A321 1C2 U72	12V DC 5W	G1/8"	G1/8"	42.60
A321 1C2 U73	24V DC 5W	G1/8"	G1/8"	42.60
A321 1C2 U79	48V DC 3,1W	G1/8"	G1/8"	42.60
A321 1C2 U710	110V DC 3,1W	G1/8"	G1/8"	42.60
A321 1C2 U7H	12V DC 3,1W 24V AC 3,5VA	G1/8"	G1/8"	42.60
A321 1C2 U7K	110V AC 3,8VA 125V AC 5,5VA	G1/8"	G1/8"	42.60
A321 1C2 U7J	230V AC 3,5VA 240V AC 4VA	G1/8"	G1/8"	42.60

Maximale werkdruk:
-0,9 ÷ 10 bar

Magneetventiel 2/2 NO - G1/8"
Flow 96 NL/min, Orifice 1.8mm

0158				
A322 1C2	Valve only	G1/8"	M5	30.70
A322 1C2 U72	12V DC 5W	G1/8"	M5	42.10
A322 1C2 U73	24V DC 5W	G1/8"	M5	42.10
A322 1C2 U79	48V DC 3,1W	G1/8"	M5	42.10
A322 1C2 U710	110V DC 3,1W	G1/8"	M5	42.10
A322 1C2 U7H	12V DC 3,1W 24V AC 3,5VA	G1/8"	M5	42.10
A322 1C2 U7K	110V AC 3,8VA 125V AC 5,5VA	G1/8"	M5	42.10
A322 1C2 U7J	230V AC 3,5VA 240V AC 4VA	G1/8"	M5	42.10

Maximale werkdruk:
-0,9 ÷ 9 bar

Magneetventiel 2/2 NC - G1/8"
Flow 100 NL/min, Orifice 2mm

0158				
A321 1D2	Valve only	G1/8"	G1/8"	31.75
A321 1D2 U72	12V DC 5W	G1/8"	G1/8"	31.75
A321 1D2 U73	24V DC 5W	G1/8"	G1/8"	43.15
A321 1D2 U79	48V DC 3,1W	G1/8"	G1/8"	43.15
A321 1D2 U710	110V DC 3,1W	G1/8"	G1/8"	43.15
A321 1D2 U7H	12V DC 3,1W 24V AC 3,5VA	G1/8"	G1/8"	43.15
A321 1D2 U7K	110V AC 3,8VA 125V AC 5,5VA	G1/8"	G1/8"	43.15
A321 1D2 U7J	230V AC 3,5VA 240V AC 4VA	G1/8"	G1/8"	43.15

Maximale werkdruk:
-0,9 ÷ 10 bar

Magneetventiel 3/2 NC - M5
Flow 60 NL/min, Orifice 1.5mm

0158					
A331 0C2	Valve only	M5	M5	M5	25.90
A331 0C2 U72	12V DC 5W	M5	M5	M5	37.25
A331 0C2 U73	24V DC 5W	M5	M5	M5	37.25
A331 0C2 U79	48V DC 3,1W	M5	M5	M5	37.25
A331 0C2 U710	110V DC 3,1W	M5	M5	M5	37.25
A331 0C2 U7H	12V DC 3,1W 24V AC 3,5VA	M5	M5	M5	37.25
A331 0C2 U7K	110V AC 3,8VA 125V AC 5,5VA	M5	M5	M5	37.25
A331 0C2 U7J	230V AC 3,5VA 240V AC 4VA	M5	M5	M5	37.25

Maximale werkdruk:
-0,9 ÷ 6 bar

Magneetventiel 2/2 NC - G1/8"
Flow 130 NL/min, Orifice 2.5mm

0158				
A321 1E2	Valve only	G1/8"	G1/8"	33.00
A321 1E2 U72	12V DC 5W	G1/8"	G1/8"	44.35
A321 1E2 U73	24V DC 5W	G1/8"	G1/8"	44.35
A321 1E2 U79	48V DC 3,1W	G1/8"	G1/8"	44.35
A321 1E2 U710	110V DC 3,1W	G1/8"	G1/8"	44.35
A321 1E2 U7H	12V DC 3,1W 24V AC 3,5VA	G1/8"	G1/8"	44.35
A321 1E2 U7K	110V AC 3,8VA 125V AC 5,5VA	G1/8"	G1/8"	44.35
A321 1E2 U7J	230V AC 3,5VA 240V AC 4VA	G1/8"	G1/8"	44.35

Maximale werkdruk:
-0,9 ÷ 10 bar

Magneetventiel 3/2 NC - G1/8"
Flow 66 NL/min, Orifice 1.5mm

0158					
A331 1C2	Valve only	G1/8"	G1/8"	M5	21.55
A331 1C2 U72	12V DC 5W	G1/8"	G1/8"	M5	32.95
A331 1C2 U73	24V DC 5W	G1/8"	G1/8"	M5	32.95
A331 1C2 U79	48V DC 3,1W	G1/8"	G1/8"	M5	32.95
A331 1C2 U710	110V DC 3,1W	G1/8"	G1/8"	M5	32.95
A331 1C2 U7H	12V DC 3,1W 24V AC 3,5VA	G1/8"	G1/8"	M5	32.95
A331 1C2 U7K	110V AC 3,8VA 125V AC 5,5VA	G1/8"	G1/8"	M5	32.95
A331 1C2 U7J	230V AC 3,5VA 240V AC 4VA	G1/8"	G1/8"	M5	32.95

KELM™
pneumatiek

Hydrauliek

Snel-
koppelingen

Afsluiters

Roestvast
staal

Fittingen

Lucht-
conditionering

Gereedschap

Pneumatiek

Diversen

Malleabele
fittings
& staal

Ringleiding-
systemen

Slangen

Compressoren

Serie A - direct werkende magneetventielen

Werking 2/2 - 3/2 NC en NO Medium
Aansluiting M5, G1/8" en Ø 4mm cartridge Gefilterde lucht, zonder smering

Temperatuur: 0°C ÷ 60°C
-20°C met droge lucht

Maximale werkdruk: -0,9 ÷ 7 bar

Magneetventiel 3/2 NO - M5
Flow 45 NL/min, Orifice 1.5mm

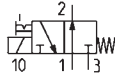

0158					
A332 0C2	Valve only	M5	M5	M5	30.70
A332 0C2 U72	12V DC 5W	M5	M5	M5	42.10
A332 0C2 U73	24V DC 5W	M5	M5	M5	42.10
A332 0C2 U79	48V DC 3,1W	M5	M5	M5	42.10
A332 0C2 U710	110V DC 3,1	M5	M5	M5	42.10
A332 0C2 U7H	12V DC 3,1W 24V AC 3,5VA	M5	M5	M5	42.10
A332 0C2 U7K	110V AC 3,8VA 125V AC 5,5VA	M5	M5	M5	42.10
A332 0C2 U7J	230V AC 3,5VA 240V AC 4VA	M5	M5	M5	42.10

Magneetventiel 3/2 NO - G1/8"
Flow 50 NL/min, Orifice 1.5mm

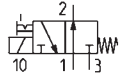

0158					
A332 1C2	Valve only	M5	G1/8"	G1/8"	30.70
A332 1C2 U72	12V DC 5W	M5	G1/8"	G1/8"	42.10
A332 1C2 U73	24V DC 5W	M5	G1/8"	G1/8"	42.10
A332 1C2 U79	48V DC 3,1W	M5	G1/8"	G1/8"	42.10
A332 1C2 U710	110V DC 3,1W	M5	G1/8"	G1/8"	42.10
A332 1C2 U7H	12V DC 3,1W 24V AC 3,5VA	M5	G1/8"	G1/8"	42.10
A332 1C2 U7K	110V AC 3,8VA 125V AC 5,5VA	M5	G1/8"	G1/8"	42.10
A332 1C2 U7J	230V AC 3,5VA 240V AC 4VA	M5	G1/8"	G1/8"	42.10



Serie 6 - direct werkende magneetventielen

Werking 2/2 - 3/2 NO - NC Medium
Aansluiting G1/8" - G3/8" en Ø 4mm cartridge Gefilterde lucht en inert gas, zonder smering

Temperatuur: 0°C ÷ 80°C
-20°C met droge lucht

Maximale werkdruk: 1 ÷ 10 bar

Magneetventiel 3/2 NC - G1/8"
Flow 130 NL/min, Orifice 2mm

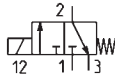

0158					
638 150 A6B	24V 50/60Hz	G1/8"	G1/8"	G1/8"	46.10
638 150 A6C	48V 50/60Hz	G1/8"	G1/8"	G1/8"	46.10
638 150 A6D	110V 50/60Hz	G1/8"	G1/8"	G1/8"	46.10
638 150 A6E	230V 50/60Hz	G1/8"	G1/8"	G1/8"	46.10
638 150 A62	12V DC	G1/8"	G1/8"	G1/8"	46.10
638 150 A63	24V DC	G1/8"	G1/8"	G1/8"	46.10
638 150 A64	48V DC	G1/8"	G1/8"	G1/8"	46.10
638 150 A66	110V DC	G1/8"	G1/8"	G1/8"	46.10

Magneetventiel 2/2 NC - G3/8"
Flow 230 NL/min, Orifice 2.5mm

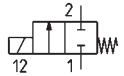

0158				
623 15E A6B	24V 50/60Hz	G3/8"	G3/8"	65.85
623 15E A6C	48V 50/60Hz	G3/8"	G3/8"	65.85
623 15E A6D	110V 50/60Hz	G3/8"	G3/8"	65.85
623 15E A6E	230V 50/60Hz	G3/8"	G3/8"	65.85
623 15E A62	12V DC	G3/8"	G3/8"	65.85
623 15E A63	24V DC	G3/8"	G3/8"	65.85
623 15E A64	48V DC	G3/8"	G3/8"	65.85
623 15E A66	110V DC	G3/8"	G3/8"	65.85



Magneetventiel 3/2 NO - G1/8"
Flow 80 NL/min, Orifice 2mm

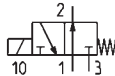

0158					
648 150 A6B	24V 50/60Hz	G1/8"	G1/8"	G1/8"	50.95
648 150 A6C	48V 50/60Hz	G1/8"	G1/8"	G1/8"	50.95
648 150 A6D	110V 50/60Hz	G1/8"	G1/8"	G1/8"	50.95
648 150 A6E	230V 50/60Hz	G1/8"	G1/8"	G1/8"	50.95
648 150 A62	12V DC	G1/8"	G1/8"	G1/8"	50.95
648 150 A63	24V DC	G1/8"	G1/8"	G1/8"	50.95
648 150 A64	48V DC	G1/8"	G1/8"	G1/8"	50.95
648 150 A66	110V DC	G1/8"	G1/8"	G1/8"	50.95

Magneetventiel 2/2 NC - G3/8"
Flow 333 NL/min, Orifice 3mm

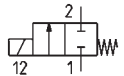

0158				
623 15F A6B	24V 50/60Hz	G3/8"	G3/8"	65.85
623 15F A6C	48V 50/60Hz	G3/8"	G3/8"	65.85
623 15F A6D	110V 50/60Hz	G3/8"	G3/8"	65.85
623 15F A6E	230V 50/60Hz	G3/8"	G3/8"	65.85
623 15F A62	12V DC	G3/8"	G3/8"	65.85
623 15F A63	24V DC	G3/8"	G3/8"	65.85
623 15F A64	48V DC	G3/8"	G3/8"	65.85
623 15F A66	110V DC	G3/8"	G3/8"	65.85

Hoofdstuk 9 – Pneumatiek

- KELM™ pneumatiek
- Hydrauliek
- Snelkoppelingen
- Afsluiters
- Roestvast staal
- Fittingen
- Luchtconditionering
- Gereedschap
- Pneumatiek
- Diversen
- Malleebele fittingen & staal
- Ringleidingssystemen
- Slangen
- Compressoren

Serie 6 - direct werkende magneetventielen

Werking 2/2 - 3/2 NO - NC

Medium

Aansluiting G1/8" - G3/8" en Ø 4mm cartridge

Gefilterde lucht en inert gas, zonder smering

Temperatuur:
0°C ÷ 80°C
-20°C met droge lucht



Maximale werkdruk:
1 - 10 bar



Magneetventiel 2/2 NC - G3/8"
Flow 520 NL/min, Orifice 4mm

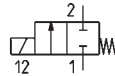

0158				
623 15G A6B	24V 50/60Hz	G3/8"	G3/8"	65.85
623 15G A6C	48V 50/60Hz	G3/8"	G3/8"	65.85
623 15G A6D	110V 50/60Hz	G3/8"	G3/8"	65.85
623 15G A6E	230V 50/60Hz	G3/8"	G3/8"	65.85
623 15G A62	12V DC	G3/8"	G3/8"	65.85
623 15G A63	24V DC	G3/8"	G3/8"	65.85
623 15G A64	48V DC	G3/8"	G3/8"	65.85
623 15G A66	110V DC	G3/8"	G3/8"	65.85

Magneetventiel 3/2 NC Ø 4mm, Rijgbaar,
Flow 108 NL/min, Orifice 2mm

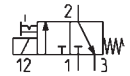

0158					
63CM 101 A6B	24V 50/60Hz	G1/8"	Ø4 mm	G1/8"	59.35
63CM 101 A6C	48V 50/60Hz	G1/8"	Ø4 mm	G1/8"	59.35
63CM 101 A6D	110V 50/60Hz	G1/8"	Ø4 mm	G1/8"	59.35
63CM 101 A6E	230V 50/60Hz	G1/8"	Ø4 mm	G1/8"	59.35
63CM 101 A62	12V DC	G1/8"	Ø4 mm	G1/8"	59.35
63CM 101 A63	24V DC	G1/8"	Ø4 mm	G1/8"	59.35
63CM 101 A64	48V DC	G1/8"	Ø4 mm	G1/8"	59.35
63CM 101 A66	110V DC	G1/8"	Ø4 mm	G1/8"	59.35

Magneetventiel 3/2 NC - G1/8" Rijgbaar,
Flow 120 NL/min, Orifice 2mm

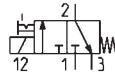

0158					
638M 101 A6B	24V 50/60Hz	G1/8"	G1/8"	G1/8"	55.55
638M 101 A6C	48V 50/60Hz	G1/8"	G1/8"	G1/8"	55.55
638M 101 A6D	110V 50/60Hz	G1/8"	G1/8"	G1/8"	55.55
638M 101 A6E	230V 50/60Hz	G1/8"	G1/8"	G1/8"	55.55
638M 101 A62	12V DC	G1/8"	G1/8"	G1/8"	55.55
638M 101 A63	24V DC	G1/8"	G1/8"	G1/8"	55.55
638M 101 A64	48V DC	G1/8"	G1/8"	G1/8"	55.55
638M 101 A66	110V DC	G1/8"	G1/8"	G1/8"	55.55

Serie 6 - kabelstekker



DIN 43650

0158		
124-800	IP65, PG9	2.10

KELM™
pneumatiek

Hydrauliek

Snel-
koppelingen

Afsluiters

Roestvast
staal

Fittingen

Lucht-
conditionering

Gereedschap

Pneumatiek

Diversen

Malleabele
fittingen
& staal

Ringleiding-
systemen

Slangen

Compressoren

Serie 3 - elektropneumatische magneetventielen

Werking 2x3/2, 3/2, 5/2, 5/3 - NC, NO, CC, CO, CP

Aansluiting G1/8", 700 NL/min

Aansluiting G1/4", 1.300 NL/min

- Ventielen geschikt voor vacuüm zijn op aanvraag leverbaar
- Zware industriële kwaliteit
- Met nood/handbediening
- Ook voor gebruik op basisplaat (ventieleiland)

Temperatuur:
0°C ÷ 60°C
-20°C met droge lucht

Medium
Gefilterde lucht, zonder smering

Materiaal
Aluminium huis, RVS plunger, NBR pakkingen

Maximale werkdruk:
2,5 ÷ 10 bar



Magneetventiel 3/2 NC - G1/8"
Flow 700 NL/min

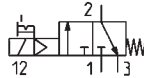

0158			
338 015 02	Valve Only	G1/8"	57.40
338 015 02 U72	12V DC 5W	G1/8"	68.80
338 015 02 U73	24V DC 5W	G1/8"	68.80
338 015 02 U79	48V DC 3,1W	G1/8"	68.80
338 015 02 U710	110V DC 3,2W	G1/8"	68.80
338 015 02 U77	24V DC 3,1W 48V AC 3,5VA	G1/8"	68.80
338 015 02 U7H	12V DC 3,1 W 24V AC 3,5VA	G1/8"	68.80
338 015 02 U7J	230V AC 3,5VA 240V AC 4VA	G1/8"	68.80
338 015 02 U7K	110V AC 3,8VA 125V AC 5,5VA	G1/8"	68.80

Magneetventiel 3/2 NO - G1/8"
Flow 700 NL/min

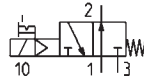

0158			
348 015 02	Valve Only	G1/8"	57.40
348 015 02 U72	12V DC 5W	G1/8"	68.80
348 015 02 U73	24V DC 5W	G1/8"	68.80
348 015 02 U79	48V DC 3,1W	G1/8"	68.80
348 015 02 U710	110V DC 3,2W	G1/8"	68.80
348 015 02 U77	24V DC 3,1W 48V AC 3,5VA	G1/8"	68.80
348 015 02 U7H	12V DC 3,1 W 24V AC 3,5VA	G1/8"	68.80
348 015 02 U7J	230V AC 3,5VA 240V AC 4VA	G1/8"	68.80
348 015 02 U7K	110V AC 3,8VA 125V AC 5,5VA	G1/8"	68.80

Maximale werkdruk:
1,5 ÷ 10 bar



Magneetventiel 3/2 Bi-stabiel - G1/8"
Flow 700 NL/min

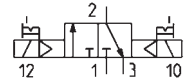

0158			
338 011 02	Valve Only	G1/8"	78.00
338 011 02 U72	12V DC 5W	G1/8"	100.75
338 011 02 U73	24V DC 5W	G1/8"	100.75
338 011 02 U79	48V DC 3,1W	G1/8"	100.75
338 011 02 U710	110V DC 3,2W	G1/8"	100.75
338 011 02 U77	24V DC 3,1W 48V AC 3,5VA	G1/8"	100.75
338 011 02 U7H	12V DC 3,1 W 24V AC 3,5VA	G1/8"	100.75
338 011 02 U7J	230V AC 3,5VA 240V AC 4VA	G1/8"	100.75
338 011 02 U7K	110V AC 3,8VA 125V AC 5,5VA	G1/8"	100.75



Magneetventiel 2x 3/2 NC - G1/8"
Flow 700 NL/min

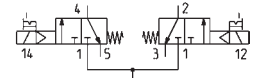

0158			
338D 015 02	Valve Only	G1/8"	112.20
338D 015 02 U72	12V DC 5W	G1/8"	134.90
338D 015 02 U73	24V DC 5W	G1/8"	134.90
338D 015 02 U79	48V DC 3,1W	G1/8"	134.90
338D 015 02 U710	110V DC 3,2W	G1/8"	134.90
338D 015 02 U77	24V DC 3,1W 48V AC 3,5VA	G1/8"	134.90
338D 015 02 U7H	12V DC 3,1 W 24V AC 3,5VA	G1/8"	134.90
338D 015 02 U7J	230V AC 3,5VA 240V AC 4VA	G1/8"	134.90
338D 015 02 U7K	110V AC 3,8VA 125V AC 5,5VA	G1/8"	134.90

Magneetventiel 2x 3/2 NO - G1/8"
Flow 700 NL/min

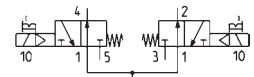

0158			
348D 015 02	Valve Only	G1/8"	112.20
348D 015 02 U72	12V DC 5W	G1/8"	134.90
348D 015 02 U73	24V DC 5W	G1/8"	134.90
348D 015 02 U79	48V DC 3,1W	G1/8"	134.90
348D 015 02 U710	110V DC 3,2W	G1/8"	134.90
348D 015 02 U77	24V DC 3,1W 48V AC 3,5VA	G1/8"	134.90
348D 015 02 U7H	12V DC 3,1 W 24V AC 3,5VA	G1/8"	134.90
348D 015 02 U7J	230V AC 3,5VA 240V AC 4VA	G1/8"	134.90
348D 015 02 U7K	110V AC 3,8VA 125V AC 5,5VA	G1/8"	134.90

Serie 3 - elektropneumatische magneetventielen



Maximale werkdruk:
2,5 ÷ 10 bar



Magneetventiel 5/2 - G1/8"
Flow 700 NL/min

0158



358 015 02	Valve Only	G1/8"	62.60
358 015 02 U72	12V DC 5W	G1/8"	74.00
358 015 02 U73	24V DC 5W	G1/8"	74.00
358 015 02 U79	48V DC 3,1W	G1/8"	74.00
358 015 02 U710	110V DC 3,2W	G1/8"	74.00
358 015 02 U77	24V DC 3,1W 48V AC 3,5VA	G1/8"	74.00
358 015 02 U7H	12V DC 3,1 W 24V AC 3,5VA	G1/8"	74.00
358 015 02 U7J	230V AC 3,5VA 240V AC 4VA	G1/8"	74.00
358 015 02 U7K	110V AC 3,8VA 125V AC 5,5VA	G1/8"	74.00

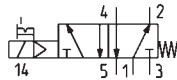

Maximale werkdruk:
2 ÷ 10 bar



Magneetventiel 5/3 CC - G1/8"
Flow 700 NL/min

0158



368 011 02	Valve Only	G1/8"	104.75
368 011 02 U72	12V DC 5W	G1/8"	127.50
368 011 02 U73	24V DC 5W	G1/8"	127.50
368 011 02 U79	48V DC 3,1W	G1/8"	127.50
368 011 02 U710	110V DC 3,2W	G1/8"	127.50
368 011 02 U77	24V DC 3,1W 48V AC 3,5VA	G1/8"	127.50
368 011 02 U7H	12V DC 3,1 W 24V AC 3,5VA	G1/8"	127.50
368 011 02 U7J	230V AC 3,5VA 240V AC 4VA	G1/8"	127.50
368 011 02 U7K	110V AC 3,8VA 125V AC 5,5VA	G1/8"	127.50

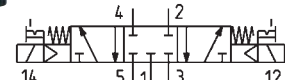

Maximale werkdruk:
1,5 ÷ 10 bar



Magneetventiel 5/2 Bi-stabiel - G1/8"
Flow 700 NL/min

0158



358 011 02	Valve Only	G1/8"	84.55
358 011 02 U72	12V DC 5W	G1/8"	95.95
358 011 02 U73	24V DC 5W	G1/8"	95.95
358 011 02 U79	48V DC 3,1W	G1/8"	95.95
358 011 02 U710	110V DC 3,2W	G1/8"	95.95
358 011 02 U77	24V DC 3,1W 48V AC 3,5VA	G1/8"	95.95
358 011 02 U7H	12V DC 3,1 W 24V AC 3,5VA	G1/8"	95.95
358 011 02 U7J	230V AC 3,5VA 240V AC 4VA	G1/8"	95.95
358 011 02 U7K	110V AC 3,8VA 125V AC 5,5VA	G1/8"	95.95

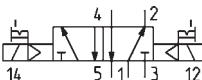

Magneetventiel 5/3 CO - G1/8"
Flow 700 NL/min

0158



378 011 02	Valve Only	G1/8"	125.95
378 011 02 U72	12V DC 5W	G1/8"	148.45
378 011 02 U73	24V DC 5W	G1/8"	148.45
378 011 02 U79	48V DC 3,1W	G1/8"	148.45
378 011 02 U710	110V DC 3,2W	G1/8"	148.45
378 011 02 U77	24V DC 3,1W 48V AC 3,5VA	G1/8"	148.45
378 011 02 U7H	12V DC 3,1 W 24V AC 3,5VA	G1/8"	148.45
378 011 02 U7J	230V AC 3,5VA 240V AC 4VA	G1/8"	148.45
378 011 02 U7K	110V AC 3,8VA 125V AC 5,5VA	G1/8"	148.45

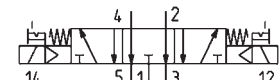

Magneetventiel 5/3 CP - G1/8"
Flow 700 NL/min

0158



388 011 02	Valve Only	G1/8"	125.95
388 011 02 U72	12V DC 5W	G1/8"	148.45
388 011 02 U73	24V DC 5W	G1/8"	148.45
388 011 02 U79	48V DC 3,1W	G1/8"	148.45
388 011 02 U710	110V DC 3,2W	G1/8"	148.45
388 011 02 U77	24V DC 3,1W 48V AC 3,5VA	G1/8"	148.45
388 011 02 U7H	12V DC 3,1 W 24V AC 3,5VA	G1/8"	148.45
388 011 02 U7J	230V AC 3,5VA 240V AC 4VA	G1/8"	148.45
388 011 02 U7K	110V AC 3,8VA 125V AC 5,5VA	G1/8"	148.45

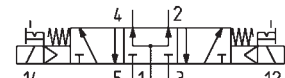

KELM™
pneumatiek

Hydrauliek

Snel-
koppelingen

Afsluiters

Roestvast
staal

Fittingen

Lucht-
conditionering

Gereedschap

Pneumatiek

Diversen

Malleabele
fittings
& staal

Ringleiding-
systemen

Slangen

Compressoren

Serie 3 - elektropneumatische magneetventielen



Maximale werkdruk:
2,5 ÷ 10 bar



Magneetventiel 3/2 NC - G1/4"
Flow 1300 NI/min

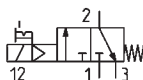

0158



334 015 02	Valve Only	G1/4"	66.50
334 015 02 U72	12V DC 5W	G1/4"	77.90
334 015 02 U73	24V DC 5W	G1/4"	77.90
334 015 02 U79	48V DC 3,1W	G1/4"	77.90
334 015 02 U710	110V DC 3,2W	G1/4"	77.90
334 015 02 U77	24V DC 3,1W 48V AC 3,5VA	G1/4"	77.90
334 015 02 U7H	12V DC 3,1 W 24V AC 3,5VA	G1/4"	77.90
334 015 02 U7J	230V AC 3,5VA 240V AC 4VA	G1/4"	77.90
334 015 02 U7K	110V AC 3,8VA 125V AC 5,5VA	G1/4"	77.90



Maximale werkdruk:
1,5 ÷ 10 bar



Magneetventiel 3/2 Bi-stabiel - G1/4"
Flow 1300 NI/min

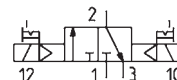

0158



334 011 02	Valve Only	G1/4"	98.70
334 011 02 U72	12V DC 5W	G1/4"	121.40
334 011 02 U73	24V DC 5W	G1/4"	121.40
334 011 02 U79	48V DC 3,1W	G1/4"	121.40
334 011 02 U710	110V DC 3,2W	G1/4"	121.40
334 011 02 U77	24V DC 3,1W 48V AC 3,5VA	G1/4"	121.40
334 011 02 U7H	12V DC 3,1 W 24V AC 3,5VA	G1/4"	121.40
334 011 02 U7J	230V AC 3,5VA 240V AC 4VA	G1/4"	121.40
334 011 02 U7K	110V AC 3,8VA 125V AC 5,5VA	G1/4"	121.40



Maximale werkdruk:
-0,9 ÷ 10 bar

Magneetventiel 3/2 NC - G1/4"
Met externe voorsturing Flow 1300 NI/min

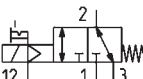

0158



334 E15 02	Valve Only	G1/4"	M5	71.15
334 E15 02 U72	12V DC 5W	G1/4"	M5	82.50
334 E15 02 U73	24V DC 5W	G1/4"	M5	82.50
334 E15 02 U79	48V DC 3,1W	G1/4"	M5	82.50
334 E15 02 U710	110V DC 3,2W	G1/4"	M5	82.50
334 E15 02 U77	24V DC 3,1W 48V AC 3,5VA	G1/4"	M5	82.50
334 E15 02 U7H	12V DC 3,1 W 24V AC 3,5VA	G1/4"	M5	82.50
334 E15 02 U7J	230V AC 3,5VA 240V AC 4VA	G1/4"	M5	82.50
334 E15 02 U7K	110V AC 3,8VA 125V AC 5,5VA	G1/4"	M5	82.50

Magneetventiel 3/2 Bi-stabiel - G1/4"
Met externe voorsturing Flow 1300 NI/min

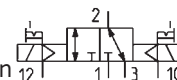

0158



334 E11 02	Valve Only	G1/4"	M5	81.80
334 E11 02 U72	12V DC 5W	G1/4"	M5	104.55
334 E11 02 U73	24V DC 5W	G1/4"	M5	104.55
334 E11 02 U79	48V DC 3,1W	G1/4"	M5	104.55
334 E11 02 U710	110V DC 3,2W	G1/4"	M5	104.55
334 E11 02 U77	24V DC 3,1W 48V AC 3,5VA	G1/4"	M5	104.55
334 E11 02 U7H	12V DC 3,1 W 24V AC 3,5VA	G1/4"	M5	104.55
334 E11 02 U7J	230V AC 3,5VA 240V AC 4VA	G1/4"	M5	104.55
334 E11 02 U7K	110V AC 3,8VA 125V AC 5,5VA	G1/4"	M5	104.55

Serie 3 - elektropneumatische magneetventielen



Maximale werkdruk:
2,5 ÷ 10 bar



Magneetventiel 5/2 - G1/4"
Flow 1300 NL/min

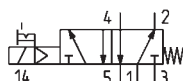

0158



354 015 02	Valve Only	G1/4"	73.65
354 015 02 U72	12V DC 5W	G1/4"	84.95
354 015 02 U73	24V DC 5W	G1/4"	84.95
354 015 02 U79	48V DC 3,1W	G1/4"	84.95
354 015 02 U710	110V DC 3,2W	G1/4"	84.95
354 015 02 U77	24V DC 3,1W 48V AC 3,5VA	G1/4"	84.95
354 015 02 U7H	12V DC 3,1W 24V AC 3,5VA	G1/4"	84.95
354 015 02 U7J	230V AC 3,5VA 240V AC 4VA	G1/4"	84.95
354 015 02 U7K	110V AC 3,8VA 125V AC 5,5VA	G1/4"	84.95



Maximale werkdruk:
1,5 ÷ 10 bar



Magneetventiel 5/2 Bi-stabiel - G1/4"
Flow 1300 NL/min

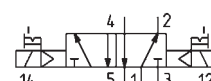

0158



354 011 02	Valve Only	G1/4"	98.70
354 011 02 U72	12V DC 5W	G1/4"	121.40
354 011 02 U73	24V DC 5W	G1/4"	121.40
354 011 02 U79	48V DC 3,1W	G1/4"	121.40
354 011 02 U710	110V DC 3,2W	G1/4"	121.40
354 011 02 U77	24V DC 3,1W 48V AC 3,5VA	G1/4"	121.40
354 011 02 U7H	12V DC 3,1W 24V AC 3,5VA	G1/4"	121.40
354 011 02 U7J	230V AC 3,5VA 240V AC 4VA	G1/4"	121.40
354 011 02 U7K	110V AC 3,8VA 125V AC 5,5VA	G1/4"	121.40



Maximale werkdruk:
-0,9 ÷ 10 bar

Magneetventiel 5/2 - G1/4"
Met externe voorsturing Flow 1300 NL/min

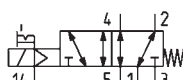

0158



354 E15 02	Valve Only	G1/4"	M5	74.55
354 E15 02 U72	12V DC 5W	G1/4"	M5	85.95
354 E15 02 U73	24V DC 5W	G1/4"	M5	85.95
354 E15 02 U79	48V DC 3,1W	G1/4"	M5	85.95
354 E15 02 U710	110V DC 3,2W	G1/4"	M5	85.95
354 E15 02 U77	24V DC 3,1W 48V AC 3,5VA	G1/4"	M5	85.95
354 E15 02 U7H	12V DC 3,1W 24V AC 3,5VA	G1/4"	M5	85.95
354 E15 02 U7J	230V AC 3,5VA 240V AC 4VA	G1/4"	M5	85.95
354 E15 02 U7K	110V AC 3,8VA 125V AC 5,5VA	G1/4"	M5	85.95



Maximale werkdruk:
-0,9 ÷ 10 bar

Magneetventiel 5/2 Bi-stabiel - G1/4"
Met externe voorsturing Flow 1300 NL/min



0158



354 E11 02	Valve Only	G1/4"	M5	100.55
354 E11 02 U72	12V DC 5W	G1/4"	M5	123.30
354 E11 02 U73	24V DC 5W	G1/4"	M5	123.30
354 E11 02 U79	48V DC 3,1W	G1/4"	M5	123.30
354 E11 02 U710	110V DC 3,2W	G1/4"	M5	123.30
354 E11 02 U77	24V DC 3,1W 48V AC 3,5VA	G1/4"	M5	123.30
354 E11 02 U7H	12V DC 3,1W 24V AC 3,5VA	G1/4"	M5	123.30
354 E11 02 U7J	230V AC 3,5VA 240V AC 4VA	G1/4"	M5	123.30
354 E11 02 U7K	110V AC 3,8VA 125V AC 5,5VA	G1/4"	M5	123.30

KELM™
pneumatiek

Hydrauliek

Snel-
koppelingen

Afsluiters

Roestvast
staal

Fittingen

Lucht-
conditionering

Gereedschap

Pneumatiek

Diversen

Malleabele
fittingen
& staal

Ringleiding-
systemen

Slangen

Compressoren

Serie 3 - elektropneumatische magneetventielen



Maximale werkdruk:
2,5 ÷ 10 bar



Magneetventiel 5/3 CC - G1/4"
Flow 1300 NU/min

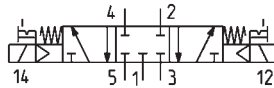

0158



364 011 02	Valve Only	G1/4"	113.90
364 011 02 U72	12V DC 5W	G1/4"	136.65
364 011 02 U73	24V DC 5W	G1/4"	136.65
364 011 02 U79	48V DC 3,1W	G1/4"	136.65
364 011 02 U710	110V DC 3,2W	G1/4"	136.65
364 011 02 U77	24V DC 3,1W 48V AC 3,5VA	G1/4"	136.65
364 011 02 U7H	12V DC 3,1W 24V AC 3,5VA	G1/4"	136.65
364 011 02 U7J	230V AC 3,5VA 240V AC 4VA	G1/4"	136.65
364 011 02 U7K	110V AC 3,8VA 125V AC 5,5VA	G1/4"	136.65



Maximale werkdruk:
2,5 ÷ 10 bar



Magneetventiel 5/3 CO - G1/4"
Flow 1300 NU/min

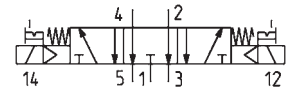

0158



374 011 02	Valve Only	G1/4"	113.90
374 011 02 U72	12V DC 5W	G1/4"	136.65
374 011 02 U73	24V DC 5W	G1/4"	136.65
374 011 02 U79	48V DC 3,1W	G1/4"	136.65
374 011 02 U710	110V DC 3,2W	G1/4"	136.65
374 011 02 U77	24V DC 3,1W 48V AC 3,5VA	G1/4"	136.65
374 011 02 U7H	12V DC 3,1W 24V AC 3,5VA	G1/4"	136.65
374 011 02 U7J	230V AC 3,5VA 240V AC 4VA	G1/4"	136.65
374 011 02 U7K	110V AC 3,8VA 125V AC 5,5VA	G1/4"	136.65



Maximale werkdruk:
-0,9 ÷ 10 bar

Magneetventiel 5/3 CC - G1/4"
Met externe voorsturing Flow 1300 NI/min

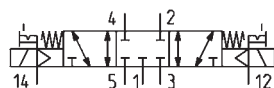

0158



364 E11 02	Valve Only	G1/4" M5	124.75
364 E11 02 U72	12V DC 5W	G1/4" M5	147.50
364 E11 02 U73	24V DC 5W	G1/4" M5	147.50
364 E11 02 U79	48V DC 3,1W	G1/4" M5	147.50
364 E11 02 U710	110V DC 3,2W	G1/4" M5	147.50
364 E11 02 U77	24V DC 3,1W 48V AC 3,5VA	G1/4" M5	147.50
364 E11 02 U7H	12V DC 3,1W 24V AC 3,5VA	G1/4" M5	147.50
364 E11 02 U7J	230V AC 3,5VA 240V AC 4VA	G1/4" M5	147.50
364 E11 02 U7K	110V AC 3,8VA 125V AC 5,5VA	G1/4" M5	147.50



Maximale werkdruk:
-0,9 ÷ 10 bar

Magneetventiel 5/3 CO - G1/4"
Met externe voorsturing Flow 1300 NI/min

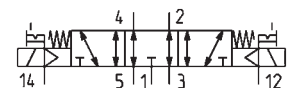

0158



374 E11 02	Valve Only	G1/4" M5	124.75
374 E11 02 U72	12V DC 5W	G1/4" M5	147.50
374 E11 02 U73	24V DC 5W	G1/4" M5	147.50
374 E11 02 U79	48V DC 3,1W	G1/4" M5	147.50
374 E11 02 U710	110V DC 3,2W	G1/4" M5	147.50
374 E11 02 U77	24V DC 3,1W 48V AC 3,5VA	G1/4" M5	147.50
374 E11 02 U7H	12V DC 3,1W 24V AC 3,5VA	G1/4" M5	147.50
374 E11 02 U7J	230V AC 3,5VA 240V AC 4VA	G1/4" M5	147.50
374 E11 02 U7K	110V AC 3,8VA 125V AC 5,5VA	G1/4" M5	147.50

Serie 3 - elektropneumatische magnetventielen



Maximale werkdruk:
2,5 ÷ 10 bar



Magneetventiel 5/2 Bi-stabiel - G1/2"
Flow 2500 NU/min

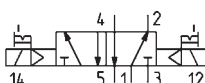

0158



Code	Valve Only	Size	Price
452C 011 02	Valve Only	G1/2"	242.00
452C 011 02 U7K	110V 50/60Hz 3,8VA	G1/2"	264.75
452C 011 02 U7J	230V 50/60Hz 3,5VA	G1/2"	264.75
452C 011 02 U7H	12V DC 3,1W 24V AC 3,5VA	G1/2"	264.75
452C 011 02 U73	24V DC 5W	G1/2"	264.75
452C 011 02 U79	48V DC 3,1W	G1/2"	264.75
452C 011 02 U710	110V DC 3,2W	G1/2"	264.75

Magneetventiel 5/2 - G1/2"
Flow 2500 NU/min

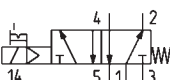

0158



Code	Valve Only	Size	Price
452C 015 02	Valve Only	G1/2"	210.20
452C 015 02 U7K	110V 50/60Hz 3,8VA	G1/2"	221.65
452C 015 02 U7J	230V 50/60Hz 3,5VA	G1/2"	221.65
452C 015 02 U7H	12V DC 3,1W 24V AC 3,5VA	G1/2"	221.65
452C 015 02 U73	24V DC 5W	G1/2"	221.65
452C 015 02 U79	48V DC 3,1W	G1/2"	221.65
452C 015 02 U710	110V DC 3,2W	G1/2"	221.65

Serie 3 en A - spoelen



Voor elektropneumatische ventielen

0158



U72	12V DC 5W	11.30
U73	24V DC 5W	11.30
U79	48V DC 3,1W	11.30
U710	110V DC 3,2W	11.30
U7H	12V DC 3,1W 24V AC 3,5VA	11.30
U7J	230V AC 3,5VA 240V AC 4VA	11.30
U7K	110V AC 3,8VA 125V AC 5,5VA	11.30
U77	24V DC 3,1W, 48V AC 3,5VA	11.70

Serie 3 en A - kabelstekker



DIN 43650

0158



122-800	-	2.10
122-701	met LED 24V AC/DC	9.50

KELM™
pneumatiek

Hydrauliek

Snel-
koppelingen

Afsluiters

Roestvast
staal

Fittingen

Lucht-
conditionering

Gereedschap

Pneumatiek

Diversen

Malleabele
fittingen
& staal

Ringleiding-
systemen

Slangen

Compressoren

Serie 3 - pneumatisch bediende ventielen

Werking 2x3/2, 3/2, 5/2, 5/3 - NC, NO, CC, CO, CP
 Aansluiting G1/8". 700 NL/min
 Aansluiting G1/4". 1.300 NL/min

- Ook voor vacuüm geschikt (op aanvraag)
- Zware industriële kwaliteit
- Ook voor gebruik op basisplaat (ventieleiland)

Temperatuur:
 0°C ÷ 60°C
 -20°C met droge lucht

Medium
 Gefilterde lucht, zonder smering
 Materiaal
 Aluminium huis, RVS plunger, NBR pakkingen

Maximale werkdruk:
 2,5 ÷ 10 bar



Pneumatisch bediend 3/2 NC - G1/8"
 Flow 700 NL/min

0158 €
338 035 **G1/8"** **32.20**

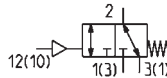

Maximale werkdruk:
 2,5 ÷ 10 bar



Pneumatisch bediend 5/2 - G1/8"
 Flow 700 NL/min

0158 €
358 035 **G1/8"** **34.20**

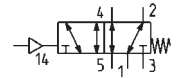

Maximale werkdruk:
 3 ÷ 10 bar

Pneumatisch bediend 3/2 NC - G1/4"
 Flow 1300 NL/min

0158 €
334 035 **G1/4"** **45.95**

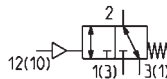

Maximale werkdruk:
 3 ÷ 10 bar

Pneumatisch bediend 5/2 - G1/4"
 Flow 1300 NL/min

0158 €
354 035 **G1/4"** **40.80**

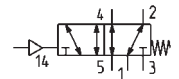

Maximale werkdruk:
 1,5 ÷ 10 bar

Pneumatisch bediend 3/2 NC Bi-stabiel G1/8",
 Flow 700 NL/min

0158 €
338 033 **G1/8"** **45.95**

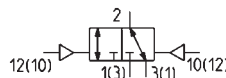

Maximale werkdruk:
 2,5 ÷ 10 bar

Pneumatisch bediend 3/2 NC Bi-stabiel G1/4",
 Flow 1300 NU/min

0158 €
334 033 **G1/4"** **45.95**

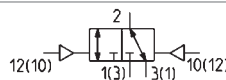

Serie 2 - mechanisch bediende mini ventielen

Werking 3/2 NO - NC

Aansluiting M5 en Ø4 mm cartridge

- Ook voor vacuüm geschikt (op aanvraag)
- Zware industriële kwaliteit
- Ook voor gebruik op basisplaat (ventieileiland)

Temperatuur:
0°C ÷ 50°C
-20°C met droge lucht



Maximale werkdruk:
2 ÷ 8 bar

Medium

Gefilterde lucht, zonder smering

Materiaal

Aluminium huis, OT58 plunger, NBR pakkingen



Werking 3/2 NC
Flow 60 NL/min

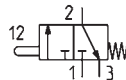

0158

Veerdruk



235 945
234 945

6 N
6 N

M5
Ø4mm

19.30
23.30



Werking 3/2 NC - hefboom en rol
Flow 60 NL/min

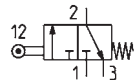

0158

Veerdruk



235 955
234 955

4 N
4 N

M5
Ø4mm

25.30
29.50



Werking 3/2 NC - paneelmontage
Flow 60 NL/min

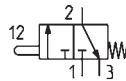

0158

Veerdruk



235 985
234 985

6 N
6 N

M5
Ø4mm

22.40
26.45



Werking - 3/2 NC hefboom
Flow 60 NL/min

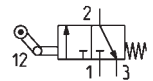

0158

Veerdruk



235 965
234 965

6 N
6 N

M5
Ø4mm

28.30
32.30

KELM™
pneumatiek

Hydrauliek

Snel-
koppelingen

Afsluiters

Roestvast
staal

Fittingen

Lucht-
conditionering

Gereedschap

Pneumatiek

Diversen

Malleabele
fittingen
& staal

Ringleiding-
systemen

Slangen

Compressoren

Serie 1 en 3 - mechanisch bediende mini ventielen

Series 3: 3/2, 5/2. G1/8"
Series 1: 3/2, 5/2. G1/8", G1/4"

Medium
Gefilterde lucht, zonder smering
Materiaal
Aluminium huis, RVS spool, NBR pakkingen

Temperatuur:
0°C ÷ 50°C
-20°C met droge lucht

Maximale werkdruk:
-0,9 ÷ 10 bar



3/2 NC veerretour
Flow 700 NI/min

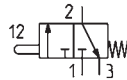

0158

Veerdruk



338 945

32 N

G1/8"

21.30



5/2 veerretour
Flow 700 NI/min

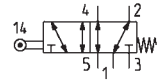

0158

Veerdruk



338 955

17 N

G1/8"

32.05



5/2 veerretour
Flow 700 NI/min

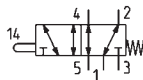

0158

Veerdruk



338 945

35 N

G1/8"

25.60



3/2 NO - NC veerretour met hefboom
en rol Flow 700 NI/min

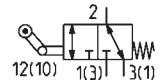

0158

Veerdruk



338 965

15 N

G1/8"

39.15



3/2 NC - NO veerretour
Flow 700 NI/min

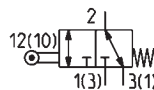

0158

Veerdruk



338 955

15 N

G1/8"

30.20



5/2 veerretour met hefboom
en rol Flow 700 NI/min

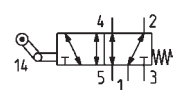

0158

Veerdruk



338 965

15 N

G1/8"

41.10

Serie 1 en 3 - mechanisch bediende mini ventielen



Maximale werkdruk:
0 ÷ 10 bar

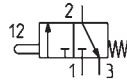

3/2 NC veerretour
Flow 1250 NL/min

0158

Veerdruk



134-945

64 N

G1/4"

41.50

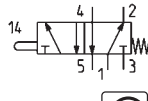

5/2 veerretour
Flow 1250NL/min

0158

Veerdruk



154-945

147 N

G1/4"

73.40

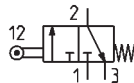

3/2 NC hefboom en rol veerretour
Flow 1250NL/min

0158

Veerdruk



134-955

41 N

G1/4"

48.10

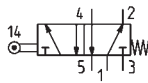

5/2 hefboom en rol veerretour
Flow 1250NL/min

0158

Veerdruk



154-955

110 N

G1/4"

89.20

Serie 2 - handbediende mini ventielen

Werking 3/2 NC, NO, 5/3 CO, CO, CP
Paneelbouw

Medium

Gefilterde lucht, zonder smering

Materiaal

Aluminium huis, OT85 plunger, NBR pakkingen



Temperatuur:
0°C ÷ 50°C



Maximale werkdruk:
2 ÷ 8 bar



3/2 drukknop bediend veerretour
Flow 60 NL/min

0158

Veerdruk



235 895

7 N

M5

36.75

234 895

7 N

Ø4mm

41.00

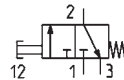

3/2 palm drukknop bediend veerretour
Flow 60 NL/min

0158

Veerdruk



235 975

7 N

M5

49.95

234 975

7 N

Ø4mm

54.30

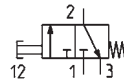

KELM™
pneumatiek

Hydrauliek

Snel-
koppelingen

Afsluiters

Roestvast
staal

Fittingen

Lucht-
conditionering

Gereedschap

Pneumatiek

Diversen

Malleabele
fittings
& staal

Ringleiding-
systemen

Slangen

Compressoren

Serie 2 - handbediende mini ventielen



Maximale werkdruk:
2 ÷ 8 bar



3/2 palm drukknop, twist en release
Flow 60 NL/min

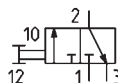

0158

Veerdruk



235 972
234 972

7 N
7 N

M5
Ø4mm

55.10
59.50



5/3 draaiknop bediend - 3 standen
Flow 60 NL/min

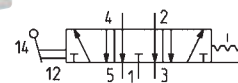

0158

Veerdruk



285 870
284 870

7 N
7 N

M5
Ø4mm

70.90
80.25



3/2 joystick bediend
Flow 60 NL/min

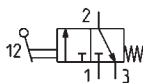

0158

Veerdruk



235 905
234 905

7 N
7 N

M5
Ø4mm

50.75
55.05



3/2 draai/sleutel bediend - 2 standen
Flow 60 NL/min

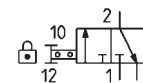

0158

Veerdruk



235 904
234 904

7 N
7 N

M5
Ø4mm

63.55
67.85



3/2 draaiknop bediend - 2 standen
Flow 60 NL/min

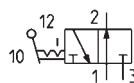

0158

Veerdruk



235 990
234 990

7 N
7 N

M5
Ø4mm

48.90
53.20



3/2 voetpedaal
Flow 60 NL/min

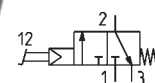

0158

Veerdruk



235 925
234 925

7 N
7 N

M5
Ø4mm

74.25
78.50

Serie 1, 3, 4 en VMS - handbediende ventielen

Werking 3/2, 5/2. 5/3 - CC, CO, CP

Temperatuur:
0°C ÷ 50°C

Maximale werkdruk:
-0,9 ÷ 10 bar

Medium
Gefilterde lucht, zonder smering
Materiaal
Aluminium huis, RVS spool, NBR pakkingen



3/2 hendel bediend - paneelmontage
Flow 700 NI/min

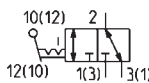

0158			
338 990	Zwart 18 N	G1/8"	34.75



5/2 hendel bediend - paneelmontage
Flow 700 NI/min

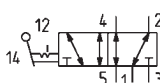

0158			
338 990	Zwart 18 N	G1/8"	38.45



3/2 drukknop bediend - paneelmontage
Flow 700 NI/min

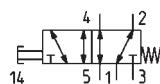

0158			
338 895	Zwart 35 N	G1/8"	34.10
338 896	Groen 35 N	G1/8"	34.10
338 897	Rood 35 N	G1/8"	34.10



5/2 drukknop bediend - paneelmontage
Flow 700 NI/min

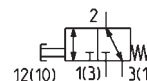

0158			
358 895	Zwart 35 N	G1/8"	38.35
358 896	Groen 35 N	G1/8"	38.35
358 897	Rood 35 N	G1/8"	38.35



3/2 palmknop bediend - paneelmontage
Flow 700 NI/min

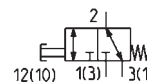

0158			
338 975	Zwart 35 N	G1/8"	38.35
338 976	Groen 35 N	G1/8"	38.35
338 977	Rood 35 N	G1/8"	38.35



5/2 palmknop bediend - paneelmontage
Flow 700 NI/min

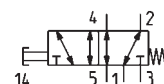

0158			
358 975	Zwart 35 N	G1/8"	43.45
358 976	Groen 35 N	G1/8"	43.45
358 977	Rood 35 N	G1/8"	43.45

KELM™
pneumatiek

Hydrauliek

Snel-
koppelingen

Afsluiters

Roestvast
staal

Fittingen

Lucht-
conditionering

Gereedschap

Pneumatiek

Diversen

Malleabele
fittings
& staal

Ringleiding-
systemen

Slangen

Compressoren

Serie 1, 3, 4 en VMS - handbediende ventielen



Maximale werkdruk:
-0,9 ÷ 10 bar



3/2 drukknop bediend - paneelmontage
Flow 700 NI/min

0158

Veerdruk



338 910

6 N

G1/8"

25.60

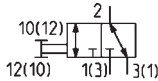

5/2 hendel bediend 90° -
paneelmontage Flow 700 NI/min

0158

Veerdruk



358 900

6 N

G1/8"

44.10

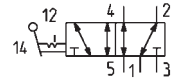

3/2 drukknop bediend - paneelmontage
Veerretour, Flow 700 NI/min

0158

Veerdruk



338 915

35 N

G1/8"

25.60

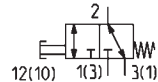

5/2 hendel bediend 90° - paneelmontage
Veerretour, Flow 700 NI/min

0158

Veerdruk



358 905

35 N

G1/8"

44.10

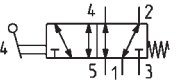

5/2 drukknop bediend - paneelmontage
Flow 700 NI/min

0158

Veerdruk



358 910

6 N

G1/8"

29.60

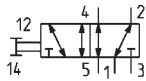

5/3 hendel bediend 90° - CC -
paneelmontage Flow 500 NI/min

0158

Veerdruk



368 900

5 N

G1/8"

49.05

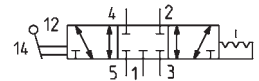

5/2 drukknop bediend - paneelmontage
Veerretour, Flow 700 NI/min

0158

Veerdruk



358 915

35 N

G1/8"

29.00

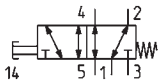

5/3 hendel bediend 90° - CC -
paneelmontage Veerretour, Flow 500 NI/min

0158

Veerdruk



368 905

20 N

G1/8"

54.70

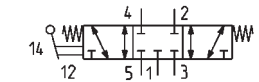

3/2 hendel bediend 90° - paneelmontage
Flow 700 NI/min

0158

Veerdruk



338 900

6 N

G1/8"

37.90

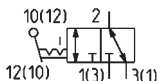

5/3 hendel bediend 90° - CO -
paneelmontage Flow 500 NI/min

0158

Veerdruk



378 900

5 N

G1/8"

49.05

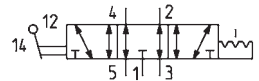

3/2 hendel bediend 90° - paneelmontage
Veerretour, Flow 700 NI/min

0158

Veerdruk



338 905

35 N

G1/8"

37.90

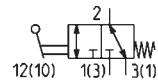

5/3 hendel bediend 90° - CO -
paneelmontage Veerretour, Flow 500 NI/min

0158

Veerdruk



378 905

20 N

G1/8"

54.70

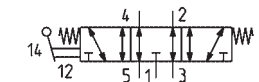

KELM™
pneumatiek

Hydrauliek

Snel-
koppelingen

Afsluiters

Roestvast
staal

Fittingen

Lucht-
conditionering

Gereedschap

Pneumatiek

Diversen

Malleabele
fittings
& staal

Ringleiding-
systemen

Slangen

Compressoren

Serie 1, 3, 4 en VMS - handbediende ventielen



Maximale werkdruk:
-0,9 ÷ 10 bar



3/2 drukknop bediend - paneelmontage
Flow 1250 NL/min

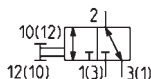

0158

Veerdruk



434 910

10 N

G1/4"

65.40

3/2 drukknop bediend - paneelmontage
Veerretour, Flow 1250 NL/min

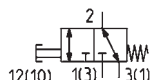

0158

Veerdruk



434 915

37 N

G1/4"

65.40



5/2 drukknop bediend - paneelmontage
Flow 1250 NL/min

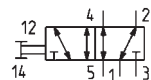

0158

Veerdruk



454 910

10 N

G1/4"

71.05

5/2 drukknop bediend - paneelmontage
Veerretour, Flow 1250 NL/min

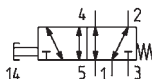

0158

Veerdruk



454 915

37 N

G1/4"

71.05



3/2 hendel bediend 90° - paneelmontage
Flow 1250 NL/min

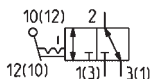

0158

Veerdruk



434 900

5 N

G1/4"

80.80

3/2 hendel bediend 90° - paneelmontage
Veerretour, Flow 1250 NL/min

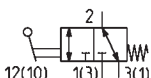

0158

Veerdruk



434 905

37 N

G1/8"

80.80



5/2 hendel bediend 90° - paneelmontage
Flow 1250 NL/min

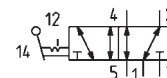

0158

Veerdruk



454 900

5 N

G1/4"

90.15

5/2 hendel bediend 90° - paneelmontage
Veerretour, Flow 1250 NL/min

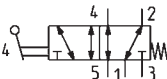

0158

Veerdruk



454 905

37 N

G1/8"

90.15



5/3 hendel bediend 90° - CC -
paneelmontage Flow 1250 NL/min



0158

Veerdruk



464 900

5 N

G1/4"

93.00

5/3 hendel bediend 90° - CC -
paneelmontage Veerretour, Flow 1250 NL/min

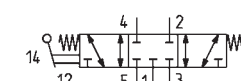

0158

Veerdruk



464 905

37 N

G1/8"

93.00



5/3 hendel bediend 90° - CO -
paneelmontage Flow 1250 NL/min

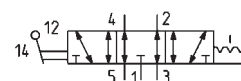

0158

Veerdruk



474 900

5 N

G1/4"

93.00

5/3 hendel bediend 90° - CO -
paneelmontage Veerretour, Flow 1250 NL/min

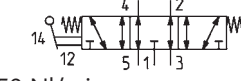

0158

Veerdruk



474 905

37 N

G1/8"

93.00

KELM™
pneumatiek

Hydrauliek

Snel-
koppelingen

Afsluiters

Roestvast
staal

Fittingen

Lucht-
conditionering

Gereedschap

Pneumatiek

Diversen

Malleabele
fittingsen
& staal

Ringleiding-
systemen

Slangen

Compressoren

Serie 1, 3, 4 en VMS - handbediende ventielen

Temperatuur:
0°C ÷ 80°C

Maximale werkdruk:
0 ÷ 8 bar

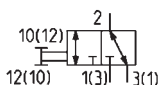

3/2 handschuifventiel

0158		Doorraat 1-2	Doorraat 2-3	€
VMS 105 M5	M5	140 NI/min	145 NI/min	16.80
VMS 118 1/8	G1/8"	600 NI/min	740 NI/min	16.80
VMS 114 1/4	G1/4"	1200 NI/min	1780 NI/min	20.30
VMS 138 3/8	G3/8"	2100 NI/min	1830 NI/min	25.15
VMS 112 1/2	G1/2"	3350 NI/min	4030 NI/min	31.15
VMS 134 3/4	G3/4"	5350 NI/min	5000 NI/min	41.25

Series PSCU - snelheidsregelventielen

Aansluiting G1/8", G1/4" en G3/8"

Medium

- Zeer nauwkeurig
- Kleine inbouwmaat
- Voor gebruik direct op de cilinder

Gefilterde lucht

Temperatuur:
0°C ÷ 60°C
-20°C met droge lucht

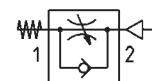

BSP male

0158		OD mm		€
PSCU 604-1/8-4	G1/8"	Ø 4	10 stuks	8.75
PSCU 604-1/8-6	G1/8"	Ø 6	10 stuks	8.45
PSCU 604-1/8-8	G1/8"	Ø 8	10 stuks	9.35
PSCU 606-1/4-6	G1/4"	Ø 6	10 stuks	9.20
PSCU 606-1/4-8	G1/4"	Ø 8	10 stuks	9.65
PSCU 606-1/4-10	G1/4"	Ø 10	10 stuks	10.20
PSCU 608-3/8-10	G3/8"	Ø 10	10 stuks	19.75
PSCU 608-3/8-12	G3/8"	Ø 12	10 stuks	20.80

Genoemde prijs is per stuk, afname alleen per verpakkingseenheid van 10 stuks.

Series M - reduceer

Aansluiting G1/8" en G1/4"

- Industriële kwaliteit
- Geschikt voor paneelbouw

Materiaal

Messing huis, RVS veer, NBR O-ring
Aansluiting manometer: G1/8"

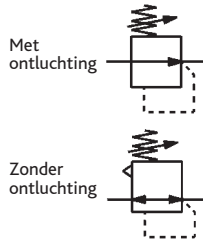
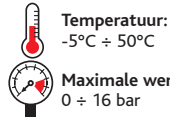

Reduceer met ontluchting (relieving)

0158			€
M008-R00	G1/8"	0,5 - 10	26.65
M004-R00	G1/4"	0,5 - 10	26.65
M008-R10	G1/8"	0 - 4	26.65
M004-R10	G1/4"	0 - 4	26.65

Reduceer zonder ontluchting (non-relieving)

0158			€
M008-R01	G1/8"	0,5 - 10	28.25
M004-R01	G1/4"	0,5 - 10	28.25
M008-R11	G1/8"	0 - 4	28.25
M004-R11	G1/4"	0 - 4	28.25

Series MC - filters

Aansluiting G1/4", G3/8" en G1/2"

- Industriële kwaliteit
- Modulaire opbouw mogelijk
- Metalen bescherm bowl

Materiaal

Zamak, NBR seals,
Technopolymer



HDPE filters

0158		Operation	µm	€
MC104-F00	G1/4"	Semi automaat (standaard)	25 µm	31.05
MC238-F00	G3/8"	Semi automaat (standaard)	25 µm	43.80
MC202-F00	G1/2"	Semi automaat (standaard)	25 µm	43.80
MC104-F10	G1/4"	Semi automaat	5 µm	31.05
MC238-F10	G3/8"	Semi automaat	5 µm	43.80
MC202-F10	G1/2"	Semi automaat	5 µm	43.80
MC104-F04	G1/4"	Op drukverlaging	25 µm	34.20
MC104-F14	G1/4"	Op drukverlaging	5 µm	34.20
MC238-F03	G3/8"	Vol automatische aftap	25 µm	105.40
MC238-F13	G3/8"	Vol automatische aftap	5 µm	105.40
MC202-F03	G1/2"	Vol automatische aftap	25 µm	105.40
MC202-F13	G1/2"	Vol automatische aftap	5 µm	105.40

Coalescing filters

0158		Operation	µm	€
MC104-FB0	G1/4"	Semi automaat	0,01 µm	88.55
MC238-FB0	G3/8"	Semi automaat	0,01 µm	101.25
MC202-FB0	G1/2"	Semi automaat	0,01 µm	101.25
MC104-FB4	G1/4"	Op drukverlaging	0,01 µm	93.95
MC238-FB3	G3/8"	Vol automatische aftap	0,01 µm	163.40
MC202-FB3	G1/2"	Vol automatische aftap	0,01 µm	163.40

Series MC - reduceer COMPACT

Aansluiting G1/4", G3/8" en G1/2"

- Industriële kwaliteit
- Modulaire opbouw mogelijk
- Geschikt voor paneelbouw

Materiaal

Zamak, Messing, NBR seals,
Technopolymer

Aansluiting manometer: G1/8"

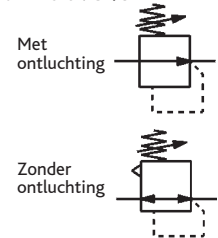
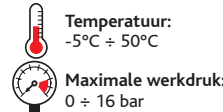

Reduceer met ontluchting (relieving)

0158			€
MC104-R00	G1/4"	0,5 - 10	36.90
MC104-R10	G1/4"	0 - 4	36.90
MC238-R00	G3/8"	0,5 - 10	50.30
MC238-R10	G3/8"	0 - 4	50.30
MC202-R00	G1/2"	0,5 - 10	50.30
MC202-R10	G1/2"	0 - 4	51.80

Modulair reduceer met ontluchting (relieving)

0158			€
MC104-M00	G1/4"	0,5 - 10	39.05

Reduceer zonder ontluchting (non-relieving)

0158			€
MC104-R01	G1/4"	0,5 - 10	36.90
MC104-R11	G1/4"	0 - 4	36.90
MC238-R01	G3/8"	0,5 - 10	50.30
MC238-R11	G3/8"	0 - 4	50.30
MC202-R01	G1/2"	0,5 - 10	50.30
MC202-R11	G1/2"	0 - 4	50.30

KELM™
pneumatiek

Hydrauliek

Snel-
koppelingen

Afsluiters

Roestvast
staal

Fittingen

Lucht-
conditionering

Gereedschap

Pneumatiek

Diversen

Malleabele
fittingen
& staal

Ringleiding-
systemen

Slangen

Compressoren

Series MC - olienevelaars

Aansluiting G1/4", G3/8" en G1/2"

- Industriële kwaliteit
- Modulaire opbouw mogelijk
- Metalen bescherm bowl van 3°E ÷ 10°E

Materiaal

Zamak, NBR seals,
Technopolymer
Olie
van 3°E ÷ 10°E



Temperatuur:
-5°C ÷ 50°C

Maximale werkdruk:
0 ÷ 16 bar

Olienevelaar

0158		Navulling olie	€
MC104-L00	G1/4"	Drukloos	42.15
MC238-L00	G3/8"	Onder druk	50.80
MC202-L00	G1/2"	Onder druk	50.80

Series MC - filter/reduceer

Aansluiting G1/4", G3/8" en G1/2"

- Industriële kwaliteit
- Modulaire opbouw mogelijk
- Metalen bescherm bowl

Materiaal

Zamak, messing,
NBR seals,
Technopolymer



Temperatuur:
-5°C ÷ 50°C

Maximale werkdruk:
0,5 ÷ 10 bar

Filter-reduceers met ontluchting (relieving)

0158		µm	Inlet	Operation	€
MC104-D00	G1/4"	25 µm (standaard)	0,3-16	Semi auto	54.90
MC104-D10	G1/4"	5 µm	0,3-16	Semi auto	54.90
MC238-D00	G3/8"	25 µm (standaard)	0,3-16	Semi auto	73.50
MC238-D10	G3/8"	5 µm	0,3-16	Semi auto	73.50
MC202-D00	G1/2"	25 µm (standaard)	0,3-16	Semi auto	73.50
MC202-D10	G1/2"	5 µm	0,3-16	Semi auto	73.50
MC238-D03	G3/8"	25 µm	1,5-12	Auto	135.25
MC238-D13	G3/8"	5 µm	1,5-12	Auto	135.25
MC202-D03	G1/2"	25 µm	1,5-12	Auto	135.25
MC202-D13	G1/2"	5 µm	1,5-12	Auto	135.25

Filter-reduceers zonder ontluchting (non-relieving)

0158		µm	Inlet	Operation	€
MC104-D01	G1/4"	25 µm	0,3-16	Semi auto	54.90
MC104-D11	G1/4"	5 µm	0,3-16	Semi auto	54.90
MC238-D01	G3/8"	25 µm	0,3-16	Semi auto	73.50
MC238-D11	G3/8"	5 µm	0,3-16	Semi auto	73.50
MC202-D01	G1/2"	25 µm	0,3-16	Semi auto	73.50
MC202-D11	G1/2"	5 µm	0,3-16	Semi auto	73.50
MC104-D04	G1/4"	25 µm	0,3-10	drukverlaging	60.35
MC104-D14	G1/4"	5 µm	0,3-10	drukverlaging	60.35

Series MC - 3/2 afsluitventiel

Aansluiting G1/4", G3/8" en G1/2"

- Industriële kwaliteit
- Modulaire opbouw mogelijk

Materiaal

Zamak, NBR seals,
Technopolymer

Temperatuur:
-5°C ÷ 50°C

Maximale werkdruk:
2 ÷ 10 bar (pneumatische versie -0,8 ÷ 10 bar)



3/2 afsluitventiel handbediend

0158		Operation	€
MC104-V01	G1/4"	Handbediend	70.85
MC238-V01	G3/8"	Handbediend	91.65
MC202-V01	G1/2"	Handbediend	91.65

3/2 NC afsluitventiel elektro-pneumatisch bediend

0158		Operation	€
MC104-V16	G1/4"	Elektro-pneumatisch	102.15
MC238-V16	G3/8"	Elektro-pneumatisch	123.40
MC202-V16	G1/2"	Elektro-pneumatisch	123.40

* Voor gewenste spoel en stekker zie: spoel t.b.v. MC...-V16 afsluitventiel

3/2 afsluitventiel pneumatisch bediend

0158		Operation	€
MC104-V36	G1/4"	Pneumatisch	88.15
MC238-V36	G3/8"	Pneumatisch	105.95
MC202-V36	G1/2"	Pneumatisch	105.95

Series MC - soft-start ventiel

Aansluiting G1/4", G3/8" en G1/2"

- Beschermt uw medewerkers en systeem
- Industriële kwaliteit
- Modulaire opbouw mogelijk

Materiaal

Zamak, NBR seals,
Technopolymer

Gebruik

Gebruiken in combinatie met 3/2 ventiel

Temperatuur:
-5°C ÷ 50°C

Maximale werkdruk:
2 ÷ 10 bar



Soft-start ventiel

0158		€
MC104-AV	G1/4"	87.95
MC238-AV	G3/8"	110.85
MC202-AV	G1/2"	110.85

Series MC - accessoires

Aansluiting G1/4", G3/8" en G1/2"

- Industriële kwaliteit
- Voor modulaire opbouw, tbv samenbouw units

Materiaal

Aftakblok: Zamak, NBR seals, Technopolymer



Benodigde montage kit voor samenbouw FRL unit

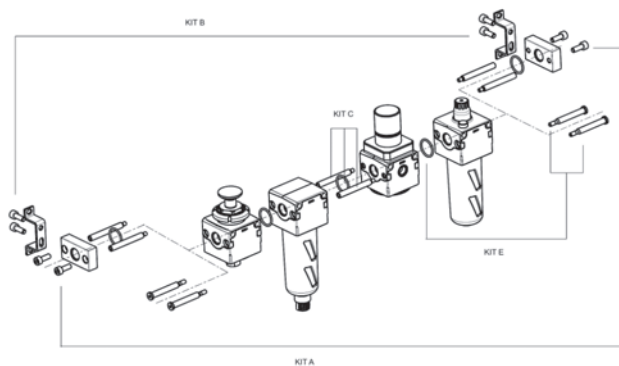

	Samenbouw zonder flenzen	Samenbouw met flenzen
P + M	1 x Kit E	1 x Kit A + 1 x Kit C
M + P	1 x Kit E	1 x Kit A + 1 x Kit C
P + P	1 x Kit F	1 x Kit A + 1 x Kit C + Kit D
P + M + P	2 x Kit E	1 x Kit A + 2 x Kit C
P + P + P	1 x Kit F + 1 x Kit C	1 x Kit A + 2 x Kit C + Kit D
M + P + P	1 x Kit E + 1 x Kit C	1 x Kit A + 2 x Kit C
M + P + M	1 x Kit G	1 x Kit A + 2 x Kit G
P + M + P + P	2 x Kit E + 1 x Kit C	1 x Kit A + 3 x Kit C
P + P + M + P + P	2 x Kit E + 2 x Kit C	1 x Kit A + 4 x Kit C

Aftakblok

0158			€
MC1-B	G1/4"		22.80
MC2-B	G3/8" - G1/2"		24.90

Aftakblok met terugslagklep

0158			€
MC1-B-VNR	G1/4"		29.10
MC2-B-VNR	G3/8" - G1/2"		32.30

Flenzen montage kit A

0158	Series		€
MC104-FL	MC Kit A	G1/4"	13.50
MC238-FL	MC Kit A	G3/8"	14.05
MC202-FL	MC Kit A	G1/2"	14.05

Montagebeugels (2 stuks) kit B

0158	Series		€
MC104-ST	MC Kit B	G1/4", 3/8", 1"	4.20

Male/female montage kit C

0158	Series		€
MC1-TMF	MC Kit C	G1/4"	2.85
MC2-TMF	MC Kit C	G3/8" - G1/2"	3.35

Female montage kit D

0158	Series		€
MC1-TFF	MC Kit D	G1/4"	2.75
MC2-TFF	MC Kit D	G3/8" - G1/2"	3.15

Schroef montage kit E

0158	Series		€
MC1-VM	MC Kit E	G1/4"	1.80
MC2-VM	MC Kit E	G3/8" - G1/2"	2.10

Schroeven male/female montage kit F

0158	Series		€
MC1-VMF	MC Kit F	G1/4"	5.05
MC2-VMF	MC Kit F	G3/8" - G1/2"	5.60

Schroeven montage kit G

0158	Series		€
MC1-VMD	MC Kit G	G1/4"	3.15
MC2-VMD	MC Kit G	G3/8" - G1/2"	3.15

KELM™
pneumatiek

Hydrauliek

Snel-
koppelingen

Afsluiters

Roestvast
staal

Fittingen

Lucht-
conditionering

Gereedschap

Pneumatiek

Diversen

Malleabele
fittings
& staal

Ringleiding-
systemen

Slangen

Compressoren

Series MC - compleet samengestelde units

Aansluiting G1/4", G3/8" en G1/2"

- Industriële kwaliteit
- Modulair opgebouwd

Materiaal

Zamak, messing, NBR seals,
Technopolymer



Geassembleerde groep C

	0158		Unit bestaande uit:	€
MC104-C-5	G1/4"		MC104-D00 en L00	102.15
MC238-C-5	G3/8"		MC238-D00 en L00	129.65
MC202-C-5	G1/2"		MC202-D00 en L00	129.65
MC104-C-5-FL	G1/4"		MC104-D00, L00 en Flenzen	120.30
MC238-C-5-FL	G3/8"		MC238-D00, L00 en Flenzen	148.55
MC202-C-5-FL	G1/2"		MC202-D00, L00 en Flenzen	148.55

Geassembleerde groep E

	0158		Unit bestaande uit:	€
MC104-E-5	G1/4"		MC104-V01, D00 en L00	176.65
MC238-E-5	G3/8"		MC238-V01, D00 en L00	225.30
MC202-E-5	G1/2"		MC202-V01, D00 en L00	225.30
MC104-E-5-FL	G1/4"		MC104-V01, D00, L00 en Flenzen	195.70
MC238-E-5-FL	G3/8"		MC238-V01, D00, L00 en Flenzen	245.30
MC202-E-5-FL	G1/2"		MC202-V01, D00, L00 en Flenzen	245.30

Geassembleerde groep HN

	0158		Unit bestaande uit:	€
MC104-HNA-5	G1/4"		MC104-V01, D00, L00, V16*, AV en drukschakelaar NO	412.85
MC238-HNA-5	G3/8"		MC238-V01, D00, L00, V16*, AV en drukschakelaar NO	506.70
MC202-HNA-5	G1/2"		MC202-V01, D00, L00, V16*, AV en drukschakelaar NO	506.70
MC104-HNA-5-FL	G1/4"		MC104-V01, D00, L00, V16*, AV, PM11-NO en flenzen	431.55
MC238-HNA-5-FL	G3/8"		MC238-V01, D00, L00, V16*, AV, PM11-NO en flenzen	526.40
MC202-HNA-5-FL	G1/2"		MC202-V01, D00, L00, V16*, AV, PM11-NO en flenzen	526.40
MC104-HNC-5	G1/4"		MC104-V01, D00, L00, V16*, AV en drukschakelaar NC	412.85
MC238-HNC-5	G3/8"		MC238-V01, D00, L00, V16*, AV en drukschakelaar NC	506.70
MC202-HNC-5	G1/2"		MC202-V01, D00, L00, V16*, AV en drukschakelaar NC	506.70
MC104-HNC-5-FL	G1/4"		MC104-V01, D00, L00, V16*, AV, PM11-NC en flenzen	431.55
MC238-HNC-5-FL	G3/8"		MC238-V01, D00, L00, V16*, AV, PM11-NC en flenzen	526.40
MC202-HNC-5-FL	G1/2"		MC202-V01, D00, L00, V16*, AV, PM11-NC en flenzen	526.40

* Voor gewenste spoel en stekker zie: spoel t.b.v. MC...-V16 afsluitventiel

Geassembleerde groep N

	0158		Unit bestaande uit:	€
MC104-N-5	G1/4"		MC104-V01 en D00	130.85
MC238-N-5	G3/8"		MC238-V01 en D00	170.50
MC202-N-5	G1/2"		MC202-V01 en D00	170.50
MC104-N-5-FL	G1/4"		MC104-V01, D00 en Flenzen	149.05
MC238-N-5-FL	G3/8"		MC238-V01, D00 en Flenzen	189.40
MC202-N-5-FL	G1/2"		MC202-V01, D00 en Flenzen	189.40

Geassembleerde groep PN

	0158		Unit bestaande uit:	€
MC104-PN-5	G1/4"		MC104-D00, V16* en AV	254.75
MC238-PN-5	G3/8"		MC238-D00, V16* en AV	318.30
MC202-PN-5	G1/2"		MC202-D00, V16* en AV	318.30
MC104-PN-5-FL	G1/4"		MC104-D00, V16*, AV en Flenzen	272.75
MC238-PN-5-FL	G3/8"		MC238-D00, V16*, AV en Flenzen	337.10
MC202-PN-5-FL	G1/2"		MC202-D00, V16*, AV en Flenzen	337.10

Geassembleerde groep ZN

	0158		Unit bestaande uit:	€
MC104-ZNA-5	G1/4"		MC104-V01, D00, V16, AV en drukschakelaar NO	410.90
MC238-ZNA-5	G3/8"		MC238-V01, D00, V16, AV en drukschakelaar NO	450.55
MC202-ZNA-5	G1/2"		MC202-V01, D00, V16, AV en drukschakelaar NO	450.55
MC104-ZNA-5-FL	G1/4"		MC104-V01, D00, V16, AV, PM11-NO en flenzen	429.80
MC238-ZNA-5-FL	G3/8"		MC238-V01, D00, V16, AV, PM11-NO en flenzen	470.40
MC202-ZNA-5-FL	G1/2"		MC202-V01, D00, V16, AV, PM11-NO en flenzen	470.40
MC104-ZNC-5	G1/4"		MC104-V01, D00, V16, AV en drukschakelaar NC	410.90
MC238-ZNC-5	G3/8"		MC238-V01, D00, V16, AV en drukschakelaar NC	450.55
MC202-ZNC-5	G1/2"		MC202-V01, D00, V16, AV en drukschakelaar NC	450.55
MC104-ZNC-5-FL	G1/4"		MC104-V01, D00, V16, AV, PM11-NC en flenzen	429.80
MC238-ZNC-5-FL	G3/8"		MC238-V01, D00, V16, AV, PM11-NC en flenzen	470.40
MC202-ZNC-5-FL	G1/2"		MC202-V01, D00, V16, AV, PM11-NC en flenzen	470.40

Serie 1000 - snijringkoppelingen

- Industriële kwaliteit
- Geschikt voor koperbuizen en slang (klemring)

Materiaal
Messing vernikkeld

Draad
GAS, conisch ISO 7 (BSPT) GAS,
cilindrisch ISO 228 (BSP)



Maximale werkdruk:
40 bar



Tee koppeling - inschroef

0158	OD mm			€
1000 4-1/8	4	R1/8"	10 stuks	4.20
1000 6-1/8	6	R1/8"	10 stuks	4.20
1000 8-1/4	8	R1/4"	10 stuks	5.50
1000 10-1/4	10	R1/4"	10 stuks	8.35

Genoemde prijs is per stuk, afname alleen per verpakkingseenheid van 10 stuks.



Zij-tee koppeling - inschroef

0158	OD mm			€
1010 4-1/8	4	R1/8"	10 stuks	4.20
1010 6-1/8	6	R1/8"	10 stuks	4.20
1010 8-1/4	8	R1/4"	10 stuks	5.50
1010 10-1/4	10	R1/4"	10 stuks	8.35

Genoemde prijs is per stuk, afname alleen per verpakkingseenheid van 10 stuks.



Kniekoppeling - inschroef

0158	OD mm			€
1020 4-1/8	4	R1/8"	10 stuks	2.30
1020 6-1/8	6	R1/8"	10 stuks	2.30
1020 6-1/4	6	R1/4"	10 stuks	2.75
1020 8-1/8	8	R1/8"	10 stuks	3.10
1020 8-1/4	8	R1/4"	10 stuks	3.10
1020 8-3/8	8	R3/8"	10 stuks	4.05
1020 10-1/4	10	R1/4"	10 stuks	4.50
1020 10-3/8	10	R3/8"	10 stuks	4.85
1020 10-1/2	10	R1/2"	10 stuks	5.95
1020 12-1/4	12	R1/4"	10 stuks	7.15
1020 12-3/8	12	R3/8"	10 stuks	7.15
1020 12-1/2	12	R1/2"	10 stuks	7.45

Genoemde prijs is per stuk, afname alleen per verpakkingseenheid van 10 stuks.



Rechte koppeling - inschroef

0158	OD mm			€
1050 4-1/8	4	R1/8"	10 stuks	1.65
1050 6-1/8	6	R1/8"	10 stuks	1.65
1050 6-1/4	6	R1/4"	10 stuks	1.85
1050 8-1/8	8	R1/8"	10 stuks	2.35
1050 8-1/4	8	R1/4"	10 stuks	2.35
1050 8-3/8	8	R3/8"	10 stuks	2.85
1050 10-1/4	10	R1/4"	10 stuks	3.50
1050 10-3/8	10	R3/8"	10 stuks	3.55
1050 10-1/2	10	R1/2"	10 stuks	4.75
1050 12-1/4	12	R1/4"	10 stuks	5.70
1050 12-3/8	12	R3/8"	10 stuks	5.70
1050 12-1/2	12	R1/2"	10 stuks	6.05

Genoemde prijs is per stuk, afname alleen per verpakkingseenheid van 10 stuks.



Rechte koppeling - opschroef

0158	OD mm			€
1063 4-1/8	4	G1/8"	10 stuks	2.00
1063 6-1/8	6	G1/8"	10 stuks	2.00
1063 6-1/4	6	G1/4"	10 stuks	2.35
1063 8-1/8	8	G1/8"	10 stuks	2.35
1063 8-1/4	8	G1/4"	10 stuks	2.75

Genoemde prijs is per stuk, afname alleen per verpakkingseenheid van 10 stuks.

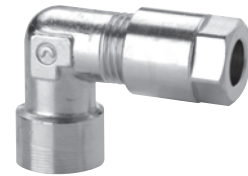

Kniekoppeling - opschroef

0158	OD mm			€
1093 4-1/8	4	G1/8"	10 stuks	3.05
1093 6-1/8	6	G1/8"	10 stuks	3.05
1093 6-1/4	6	G1/4"	10 stuks	3.60
1093 8-1/8	8	G1/8"	10 stuks	3.60
1093 8-1/4	8	G1/4"	10 stuks	4.05

Genoemde prijs is per stuk, afname alleen per verpakkingseenheid van 10 stuks.



Banjo enkel

0158	OD mm			€
1170 6-1/8	6	Ø14	10 stuks	2.65
1170 6-1/4	6	Ø18	10 stuks	2.85
1170 8-1/8	8	Ø14	10 stuks	3.15

Genoemde prijs is per stuk, afname alleen per verpakkingseenheid van 10 stuks.



Tee koppeling

0158	OD mm			€
1210 4	4		10 stuks	5.25
1210 6	6		10 stuks	5.25
1210 8	8		10 stuks	6.75
1210 10	10		10 stuks	10.55
1210 12	12		10 stuks	15.50

Genoemde prijs is per stuk, afname alleen per verpakkingseenheid van 10 stuks.

KELM™
pneumatiek

Hydrauliek

Snel-
koppelingen

Afsluiters

Roestvast
staal

Fittingen

Lucht-
conditionering

Gereedschap

Pneumatiek

Diversen

Malleabele
fittingen
& staal

Ringleiding-
systemen

Slangen

Compressoren

Serie 1000 - snijringkoppelingen



Kniekoppeling

0158	OD mm		€
1220 4	4	10 stuks	3.40
1220 6	6	10 stuks	3.40
1220 8	8	10 stuks	4.60
1220 10	10	10 stuks	6.85
1220 12	12	10 stuks	10.40

Genoemde prijs is per stuk, afname alleen per verpakkingseenheid van 10 stuks.



Rechte koppeling

0158	OD mm		€
1230 4	4	10 stuks	2.65
1230 6	6	10 stuks	2.65
1230 8	8	10 stuks	3.45
1230 10	10	10 stuks	5.15
1230 12	12	10 stuks	8.60

Genoemde prijs is per stuk, afname alleen per verpakkingseenheid van 10 stuks.



Schotdoorvoerkoppeling

0158	OD mm		€
1250 4	4	10 stuks	3.70
1250 6	6	10 stuks	3.70
1250 8	8	10 stuks	4.90
1250 10	10	10 stuks	9.05

Genoemde prijs is per stuk, afname alleen per verpakkingseenheid van 10 stuks.



Moer t.b.v. snijringkoppeling

0158	OD mm		€
1303 4-1/8	4	10 stuks	0.50
1303 6-1/8	6	10 stuks	0.50
1303 8-1/4	8	10 stuks	0.65
1303 10-3/8	10	10 stuks	1.00
1303 12-1/2	12	10 stuks	2.00

Genoemde prijs is per stuk, afname alleen per verpakkingseenheid van 10 stuks.



Knelring

0158	OD mm		€
1310 4	4	50 stuks	0.25
1310 6	6	50 stuks	0.20
1310 8	8	50 stuks	0.30
1310 10	10	50 stuks	0.40
1310 12	12	50 stuks	0.45

Genoemde prijs is per stuk, afname alleen per verpakkingseenheid van 50 stuks.



Steunhuls

0158	OD mm		€
1320 4	4	100 stuks	0.30
1320 6	6	100 stuks	0.35
1320 8	8	100 stuks	0.40
1320 10	10	100 stuks	0.50

Genoemde prijs is per stuk, afname alleen per verpakkingseenheid van 100 stuks.

Serie 1500 - opsteekkoppelingen

- Industriële kwaliteit
- Gepatendeerde Sprint® afdichting (korte draad)

Materiaal
Messing vernikkeld

Draad
GAS, conisch ISO 7 (BSPT) GAS, cilindrisch ISO 228 (BSP) M5 - M6



Tee koppeling - inschroef

0158	OD mm		€
1410 5/3-1/8	5/3	R1/8" 10 stuks	3.50
1410 6/4-1/8	6/4	R1/8" 10 stuks	3.05
1410 6/4-1/4	6/4	R1/4" 10 stuks	3.50
1410 8/6-1/8	8/6	R1/8" 10 stuks	3.55
1410 8/6-1/4	8/6	R1/4" 10 stuks	3.75
1410 10/8-1/8	10/8	R1/8" 10 stuks	4.85
1410 10/8-1/4	10/8	R1/4" 10 stuks	4.70
1410 10/8-3/8	10/8	R3/8" 10 stuks	5.60
1410 10/8-1/2	10/8	R1/2" 10 stuks	8.85
1410 12/10-3/8	12/10	R3/8" 10 stuks	7.75
1410 12/10-1/2	12/10	R1/2" 10 stuks	9.25
1410 15/12.5-1/2	15/12.5	R1/2" 10 stuks	10.75

Genoemde prijs is per stuk, afname alleen per verpakkingseenheid van 10 stuks.



Zij-tee koppeling - inschroef

0158	OD mm		€
1420 5/3-1/8	5/3	R1/8" 10 stuks	3.50
1420 6/4-1/8	6/4	R1/8" 10 stuks	3.05
1420 6/4-1/4	6/4	R1/4" 10 stuks	3.50
1420 6/4-3/8	6/4	R3/8" 10 stuks	5.40
1420 8/6-1/8	8/6	R1/8" 10 stuks	3.55
1420 8/6-1/4	8/6	R1/4" 10 stuks	3.75
1420 10/8-1/8	10/8	R1/8" 10 stuks	4.85
1420 10/8-1/4	10/8	R1/4" 10 stuks	4.60

Genoemde prijs is per stuk, afname alleen per verpakkingseenheid van 10 stuks.



Tee koppeling - inschroef draaibaar

0158	OD mm		€
1431 6/4-1/8	6/4	G1/8" 10 stuks	4.30
1431 6/4-1/4	6/4	G1/4" 10 stuks	4.75
1431 8/6-1/8	8/6	G1/8" 10 stuks	4.60
1431 8/6-1/4	8/6	G1/4" 10 stuks	4.95
1431 10/8-1/4	10/8	G1/4" 10 stuks	5.85

Genoemde prijs is per stuk, afname alleen per verpakkingseenheid van 10 stuks.

KELM™ pneumatiek

Hydrauliek

Snelkoppelingen

Afsluiters

Roestvast staal

Fittingen

Luchtconditionering

Gereedschap

Pneumatiek

Diversen

Malleabele fittingen & staal

Ringleidingssystemen

Slangen

Compressoren

Series 1500 - opsteekkoppelingen



Rechte koppeling - opschroef

0158	OD mm	Stem OD mm	Standaard	€
1463 5/3-1/8	5/3	R1/8"	10 stuks	1.60
1463 6/4-1/8	6/4	R1/8"	10 stuks	1.35
1463 6/4-1/4	6/4	R1/4"	10 stuks	1.75
1463 6/4-3/8	6/4	R3/8"	10 stuks	3.05
1463 8/6-1/8	8/6	R1/8"	10 stuks	1.50
1463 8/6-1/4	8/6	R1/4"	10 stuks	1.85
1463 8/6-3/8	8/6	R3/8"	10 stuks	3.05
1463 10/8-1/8	10/8	R1/8"	10 stuks	1.85
1463 10/8-1/4	10/8	R1/4"	10 stuks	2.00
1463 10/8-3/8	10/8	R3/8"	10 stuks	3.25
1463 10/8-1/2	10/8	R1/2"	10 stuks	4.60
1463 12/10-3/8	12/10	R3/8"	10 stuks	4.05

Genoemde prijs is per stuk, afname alleen per verpakkingseenheid van 10 stuks.



Steelekoppeling

0158	OD mm	Stem OD mm	Standaard	€
1470 6/4	6/4	6	10 stuks	1.40
1470 8/6	8/6	8	10 stuks	1.60

Genoemde prijs is per stuk, afname alleen per verpakkingseenheid van 10 stuks.



Kniekoppeling - opschroef

0158	OD mm	Stem OD mm	Standaard	€
1493 6/4-1/8	6/4	G1/8"	10 stuks	2.00
1493 6/4-1/4	6/4	G1/4"	10 stuks	3.15
1493 8/6-1/8	8/6	G1/8"	10 stuks	2.20
1493 8/6-1/4	8/6	G1/4"	10 stuks	3.15
1493 10/8-1/4	10/8	G1/4"	10 stuks	3.40
1493 12/10-3/8	12/10	G3/8"	10 stuks	5.75

Genoemde prijs is per stuk, afname alleen per verpakkingseenheid van 10 stuks.



Kniekoppeling - inschroef

0158	OD mm	Stem OD mm	Standaard	€
1500 5/3-1/8	5/3	R1/8"	10 stuks	1.70
1500 6/4-1/8	6/4	R1/8"	10 stuks	1.50
1500 6/4-1/4	6/4	R1/4"	10 stuks	1.80
1500 6/4-3/8	6/4	R3/8"	10 stuks	2.85
1500 6/4-M12	6/4	M12x1,25	10 stuks	2.00
1500 8/6-1/8	8/6	R1/8"	10 stuks	1.70
1500 8/6-1/4	8/6	R1/4"	10 stuks	1.85
1500 8/6-3/8	8/6	R3/8"	10 stuks	2.85
1500 8/6-1/2	8/6	R1/2"	10 stuks	4.75
1500 10/8-1/8	10/8	R1/8"	10 stuks	2.40
1500 10/8-1/4	10/8	R1/4"	10 stuks	2.40
1500 10/8-3/8	10/8	R3/8"	10 stuks	3.05
1500 10/8-1/2	10/8	R1/2"	10 stuks	4.75
1500 12/10-3/8	12/10	R3/8"	10 stuks	4.00
1500 12/10-1/2	12/10	R1/2"	10 stuks	5.15
1500 15/12.5-1/2	15/12,5	R1/2"	10 stuks	5.65

Genoemde prijs is per stuk, afname alleen per verpakkingseenheid van 10 stuks.



Rechte koppeling - inschroef

0158	OD mm	Stem OD mm	Standaard	€
1510 5/3-1/8	5/3	R1/8"	10 stuks	1.30
1510 6/4-1/8	6/4	R1/8"	10 stuks	1.20
1510 6/4-1/4	6/4	R1/4"	10 stuks	1.50
1510 6/4-3/8	6/4	R3/8"	10 stuks	2.00
1510 6/4-1/2	6/4	R1/2"	10 stuks	3.15
1510 6/4-M12	6/4	M12x1,25	10 stuks	1.55
1510 8/6-1/8	8/6	R1/8"	10 stuks	1.50
1510 8/6-1/4	8/6	R1/4"	10 stuks	1.55
1510 8/6-3/8	8/6	R3/8"	10 stuks	2.15
1510 8/6-1/2	8/6	R1/2"	10 stuks	3.20
1510 10/8-1/8	10/8	R1/8"	10 stuks	1.80
1510 10/8-1/4	10/8	R1/4"	10 stuks	1.80
1510 10/8-3/8	10/8	R3/8"	10 stuks	2.45
1510 10/8-1/2	10/8	R1/2"	10 stuks	3.40
1510 12/10-3/8	12/10	R3/8"	10 stuks	2.55
1510 12/10-1/2	12/10	R1/2"	10 stuks	3.70
1510 15/12.5-1/2	15/12,5	R1/2"	10 stuks	4.30

Genoemde prijs is per stuk, afname alleen per verpakkingseenheid van 10 stuks.



Rechte koppeling - inschroef Sprint®

0158	OD mm	Stem OD mm	Standaard	€
1511 5/3-M5	5/3	M5	10 stuks	1.35
1511 5/3-M6	5/3	M6	10 stuks	1.35
1511 5/3-1/8	5/3	G1/8"	10 stuks	1.50
1511 6/4-M5	6/4	M5	10 stuks	1.35
1511 6/4-M6	6/4	M6	10 stuks	1.35
1511 6/4-1/8	6/4	G1/8"	10 stuks	1.50
1511 6/4-1/4	6/4	G1/4"	10 stuks	1.80
1511 6/4-3/8	6/4	G3/8"	10 stuks	2.20
1511 8/6-1/8	8/6	G1/8"	10 stuks	1.60
1511 8/6-1/4	8/6	G1/4"	10 stuks	1.95
1511 8/6-3/8	8/6	G3/8"	10 stuks	2.25
1511 10/8-1/8	10/8	G1/8"	10 stuks	1.90
1511 10/8-1/4	10/8	G1/4"	10 stuks	2.15
1511 10/8-3/8	10/8	G3/8"	10 stuks	2.65
1511 10/8-1/2	10/8	G1/2"	10 stuks	3.80
1511 12/10-3/8	12/10	G3/8"	10 stuks	2.75
1511 12/10-1/2	12/10	G1/2"	10 stuks	4.10
1511 15/12.5-1/2	15/12,5	G1/2"	10 stuks	4.90

Genoemde prijs is per stuk, afname alleen per verpakkingseenheid van 10 stuks.



Tee koppeling

0158	OD A mm	OD B mm	Standaard	€
1540 6/4	6/4	-	10 stuks	3.55
1540 8/6-6/4	8/6	6/4	10 stuks	4.00
1540 8/6	8/6	-	10 stuks	4.00
1540 10/8	10/8	-	10 stuks	5.05
1540 10/8-6/4	10/8	6/4	10 stuks	5.50
1540 10/8-8/6	10/8	8/6	10 stuks	5.50
1540 12/10	12/10	-	10 stuks	8.60
1540 15/12.5	15/12,5	-	10 stuks	12.55

Genoemde prijs is per stuk, afname alleen per verpakkingseenheid van 10 stuks.

KELM™
pneumatiek

Hydrauliek

Snel-
koppelingen

Afsluiters

Roestvast
staal

Fittingen

Lucht-
conditionering

Gereedschap

Pneumatiek

Diversen

Malleabele
fittingen
& staal

Ringleiding-
systemen

Slangen

Compressoren

Series 1500 - opsteekkoppelingen



Kniekoppeling - inschroef draaibaar Sprint®

0158	OD mm			€
1541 6/4-1/8	6/4	G1/8"	10 stuks	2.75
1541 6/4-1/4	6/4	G1/4"	10 stuks	3.45
1541 8/6-1/8	8/6	G1/8"	10 stuks	3.10
1541 8/6-1/4	8/6	G1/4"	10 stuks	3.50
1541 10/8-1/4	10/8	G1/4"	10 stuks	4.10

Genoemde prijs is per stuk, afname alleen per verpakkingseenheid van 10 stuks.



Kniekoppeling

0158	OD mm		€
1550 6/4	6/4	10 stuks	2.65
1550 8/6	8/6	10 stuks	2.75
1550 10/8	10/8	10 stuks	3.40
1550 12/10	12/10	10 stuks	5.25
1550 15/12.5	15/12,5	10 stuks	7.35

Genoemde prijs is per stuk, afname alleen per verpakkingseenheid van 10 stuks.



Rechte koppeling - inschroef draaibaar Sprint®

0158	OD mm		€	
1560 6/4-1/8	6/4	G1/8"	10 stuks	2.65
1560 6/4-1/4	6/4	G1/4"	10 stuks	2.95
1560 8/6-1/8	8/6	G1/8"	10 stuks	2.75
1560 8/6-1/4	8/6	G1/4"	10 stuks	3.05
1560 10/8-1/4	10/8	G1/4"	10 stuks	3.15
1560 10/8-3/8	10/8	G3/8"	10 stuks	3.85
1560 12/10-3/8	12/10	G3/8"	10 stuks	4.75

Genoemde prijs is per stuk, afname alleen per verpakkingseenheid van 10 stuks.



Rechte koppeling B

0158	OD A mm	OD B mm		€
1580 5/3	5/3	-	10 stuks	2.50
1580 6/4	6/4	-	10 stuks	1.90
1580 8/6	8/6	-	10 stuks	2.20
1580 8/6-6/4	8/6	6/4	10 stuks	2.65
1580 10/8	10/8	-	10 stuks	2.75
1580 10/8-6/4	10/8	6/4	10 stuks	3.15
1580 12/10	12/10	-	10 stuks	4.00
1580 15/12.5	15/2,5	-	10 stuks	7.65

Genoemde prijs is per stuk, afname alleen per verpakkingseenheid van 10 stuks.



B

Schotdoorvoerkoppeling

0158	OD A mm	OD B mm		€
1590 5/3	5/3	-	10 stuks	3.45
1590 6/4	6/4	-	10 stuks	3.05
1590 6/4-5/3	6/4	5/3	10 stuks	3.70
1590 8/6	8/6	-	10 stuks	3.50
1590 8/6-6/4	8/6	6/4	10 stuks	4.10
1590 10/8	10/8	-	10 stuks	4.00
1590 12/10	12/10	-	10 stuks	5.15

Genoemde prijs is per stuk, afname alleen per verpakkingseenheid van 10 stuks.



Kruiskoppeling

0158	OD mm		€
1600 6/4	6/4	10 stuks	5.10
1600 8/6	8/6	10 stuks	6.35

Genoemde prijs is per stuk, afname alleen per verpakkingseenheid van 10 stuks.



Banjo enkel

0158	OD mm			€
1610 5/3-M5	5/3	M5	10 stuks	1.90
1610 5/3-M6	5/3	M6	10 stuks	1.80
1610 5/3-1/8	5/3	G1/8"	10 stuks	2.20
1610 6/4-M5	6/4	M5	10 stuks	1.80
1610 6/4-M6	6/4	M6	10 stuks	1.75
1610 6/4-1/8	6/4	G1/8"	10 stuks	2.10
1610 6/4-1/4	6/4	G1/4"	10 stuks	2.30
1610 6/4-3/8	6/4	G3/8"	10 stuks	3.60
1610 8/6-1/8	8/6	G1/8"	10 stuks	2.30
1610 8/6-1/4	8/6	G1/4"	10 stuks	2.40
1610 8/6-3/8	8/6	G3/8"	10 stuks	3.55
1610 10/8-1/8	10/8	G1/8"	10 stuks	2.65
1610 10/8-1/4	10/8	G1/4"	10 stuks	2.75
1610 10/8-3/8	10/8	G3/8"	10 stuks	3.55
1610 10/8-1/2	10/8	G1/2"	10 stuks	4.90
1610 12/10-3/8	12/10	G3/8"	10 stuks	4.50
1610 12/10-1/2	12/10	G1/2"	10 stuks	5.60
1610 15/12.5-1/2	15/12,5	G1/2"	10 stuks	5.75

Genoemde prijs is per stuk, afname alleen per verpakkingseenheid van 10 stuks.



Banjo dubbel

0158	OD mm		€
1620 6/4-M5	6/4	10 stuks	4.15
1620 6/4-1/8	6/4	10 stuks	4.95
1620 6/4-1/4	6/4	10 stuks	5.65
1620 8/6-1/8	8/6	10 stuks	5.15
1620 8/6-1/4	8/6	10 stuks	5.20

Genoemde prijs is per stuk, afname alleen per verpakkingseenheid van 10 stuks.

Series 1500 - opsteekkoppelingen



Holle bout enkel laag

0158			€
1631 01-M5	M5	10 stuks	1.30
1631 01-1/8	G1/8"	10 stuks	1.10
1631 01-1/4	G1/4"	10 stuks	1.60
1631 01-3/8	G3/8"	10 stuks	2.65
1631 01-1/2	G1/2"	10 stuks	4.35
1631 02-1/8	G1/8"	10 stuks	1.90
1631 02-1/4	G1/4"	10 stuks	2.65
1631 02-3/8	G3/8"	10 stuks	3.55
1631 03-1/8	G1/8"	10 stuks	2.75
1631 03-1/4	G1/4"	10 stuks	3.50
1631 03-3/8	G3/8"	10 stuks	4.95

Genoemde prijs is per stuk, afname alleen per verpakkingseenheid van 10 stuks.



Holle bout enkel hoog

0158			€
1635 01-1/8	G1/8"	10 stuks	1.45
1635 01-1/4	G1/4"	10 stuks	1.80
1635 01-3/8	G3/8"	10 stuks	2.85
1635 01-1/2	G1/2"	10 stuks	4.95
1635 01-M12X1.25	M12x1,25	10 stuks	2.05
1635 01-M12X1.5	M12x1,5	10 stuks	2.05
1635 02-1/8	G1/8"	10 stuks	2.75
1635 02-1/4	G1/4"	10 stuks	3.45
1635 02-3/8	G3/8"	10 stuks	4.20

Genoemde prijs is per stuk, afname alleen per verpakkingseenheid van 10 stuks.



Anti-knikveer opsteek

0158			€
1723 6/4 M10X1	6/4 M10X1	10 stuks	1.65
1723 8/6 M12X1	8/6 M12X1	10 stuks	1.85
1723 10/8 M14X1	10/8 M14X1	10 stuks	2.20
1723 12/10 M16X1	12/10 M16X1	10 stuks	2.85
1723 15/12.5 M20	15/12,5 M20X1	10 stuks	3.80

Genoemde prijs is per stuk, afname alleen per verpakkingseenheid van 10 stuks.

Series 2000 - draadfittingen



Tee BSP female

0158			€
2003 1/8	G1/8"	10 stuks	2.55
2003 1/4	G1/4"	10 stuks	3.50
2003 3/8	G3/8"	10 stuks	4.95
2003 1/2	G1/2"	10 stuks	7.15

Genoemde prijs is per stuk, afname alleen per verpakkingseenheid van 10 stuks.



Knie BSPT male Sprint®

0158			€
S2010 1/8	R1/8"	10 stuks	2.00
S2010 1/4	R1/4"	10 stuks	2.75
S2010 3/8	R3/8"	10 stuks	3.65
S2010 1/2	R1/2"	10 stuks	5.05

Genoemde prijs is per stuk, afname alleen per verpakkingseenheid van 10 stuks.



Knie BSPT male/BSP female

0158				€
2021 M5-M5	M5	M5	10 stuks	1.75
2020 1/8-1/8	R1/8"	G1/8"	10 stuks	1.70
2020 1/4-1/4	R1/4"	G1/4"	10 stuks	2.35
2020 3/8-3/8	R3/8"	G3/8"	10 stuks	3.10
2020 1/2-1/2	R1/2"	G1/2"	10 stuks	4.60
2020 3/4-3/4	R3/4"	G3/4"	10 stuks	15.15
2020 1-1	R1"	G1"	10 stuks	26.30

Genoemde prijs is per stuk, afname alleen per verpakkingseenheid van 10 stuks.



Knie BSPT male

0158			€
2010 1/8	R1/8"	10 stuks	1.70
2010 1/4	R1/4"	10 stuks	2.30
2010 3/8	R3/8"	10 stuks	3.05
2010 1/2	R1/2"	10 stuks	4.35
2010 3/4	R3/4"	10 stuks	11.95
2010 1	R1"	10 stuks	19.10

Genoemde prijs is per stuk, afname alleen per verpakkingseenheid van 10 stuks.



Knie BSP female

0158			€
2013 1/8	G1/8"	10 stuks	1.90
2013 1/4	G1/4"	10 stuks	2.65
2013 3/8	G3/8"	10 stuks	3.70
2013 1/2	G1/2"	10 stuks	6.10

Genoemde prijs is per stuk, afname alleen per verpakkingseenheid van 10 stuks.



Knie BSPT male/BSP female Sprint®

0158				€
S2020 1/8-1/8	R1/8"	G1/8"	10 stuks	1.90
S2020 1/4-1/4	R1/4"	G1/4"	10 stuks	2.65
S2020 3/8-3/8	R3/8"	G3/8"	10 stuks	3.50
S2020 1/2-1/2	R1/2"	G1/2"	10 stuks	5.15

Genoemde prijs is per stuk, afname alleen per verpakkingseenheid van 10 stuks.

KELM™
pneumatiek

Hydrauliek

Snel-
koppelingen

Afsluiters

Roestvast
staal

Fittingen

Lucht-
conditionering

Gereedschap

Pneumatiek

Diversen

Malleabele
fittingen
& staal

Ringleiding-
systemen

Slangen

Compressoren

Series 2000 - draadfittingen



Banjo enkel BSP female

0158			€
2023 M5-M5	M5	10 stuks	1.60
2023 M5-M6	M6	10 stuks	1.50
2023 1/8-1/8	G1/4"	10 stuks	1.90
2023 1/4-1/4	G3/8"	10 stuks	2.35
2023 3/8-3/8	G1/2"	10 stuks	3.15

Genoemde prijs is per stuk, afname alleen per verpakkingseenheid van 10 stuks.



Kruis BSP female

0158			€
2033 1/8	G1/8"	10 stuks	4.00
2033 1/4	G1/4"	10 stuks	5.15
2033 3/8	G3/8"	10 stuks	6.70

Genoemde prijs is per stuk, afname alleen per verpakkingseenheid van 10 stuks.

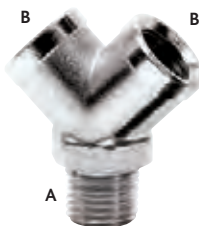

Y-stuk BSPT male/BSP female

0158				€
2040 1/8-1/8	R1/8"	G1/8"	10 stuks	3.90
2040 1/4-1/4	R1/4"	G1/4"	10 stuks	4.30
2040 3/8-3/8	R3/8"	G3/8"	10 stuks	6.25
2040 1/2-1/2	R1/2"	G1/2"	10 stuks	9.25

Genoemde prijs is per stuk, afname alleen per verpakkingseenheid van 10 stuks.



Y-stuk BSP female

0158			€
2043 1/8	G1/8"	10 stuks	3.90
2043 1/4	G1/4"	10 stuks	4.30
2043 3/8	G3/8"	10 stuks	6.25
2043 1/2	G1/2"	10 stuks	9.35

Genoemde prijs is per stuk, afname alleen per verpakkingseenheid van 10 stuks.

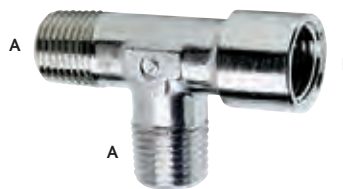

Zij-tee BSPT male/BSP female

0158				€
2050 1/8-1/8	R1/8"	G1/8"	10 stuks	2.55
2050 3/8-3/8	R3/8"	G3/8"	10 stuks	4.85
2050 1/2-1/2	R1/2"	G1/2"	10 stuks	7.00
2050 1/4-1/4	R1/4"	G1/4"	10 stuks	3.50

Genoemde prijs is per stuk, afname alleen per verpakkingseenheid van 10 stuks.



Zij-tee BSPT male/BSP female Sprint®

0158				€
S2050 1/8-1/8	R1/8"	G1/8"	10 stuks	3.60
S2050 1/4-1/4	R1/4"	G1/4"	10 stuks	4.50
S2050 3/8-3/8	R3/8"	G3/8"	10 stuks	6.35
S2050 1/2-1/2	R1/2"	G1/2"	10 stuks	8.90

Genoemde prijs is per stuk, afname alleen per verpakkingseenheid van 10 stuks.

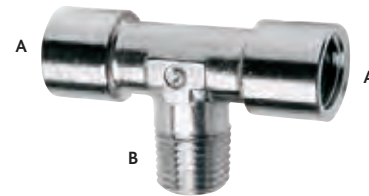

Tee BSPT male/BSP female

0158				€
2060 1/8-1/8	G1/8"	R1/8"	10 stuks	2.65
2060 1/4-1/4	G1/4"	R1/4"	10 stuks	3.50
2060 3/8-3/8	G3/8"	R3/8"	10 stuks	4.85
2060 1/2-1/2	G1/2"	R1/2"	10 stuks	7.00

Genoemde prijs is per stuk, afname alleen per verpakkingseenheid van 10 stuks.

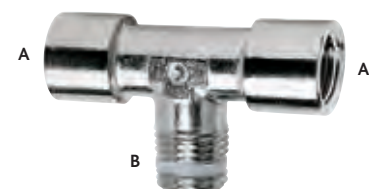

Tee BSPT male/BSP female Sprint®

0158				€
S2060 1/8-1/8	G1/8"	R1/8"	10 stuks	3.10
S2060 1/4-1/4	G1/4"	R1/4"	10 stuks	3.75
S2060 3/8-3/8	G3/8"	R3/8"	10 stuks	5.20
S2060 1/2-1/2	G1/2"	R1/2"	10 stuks	7.45

Genoemde prijs is per stuk, afname alleen per verpakkingseenheid van 10 stuks.



Tee BSPT male/BSP female

0158				€
2070 1/8-1/8	R1/8"	G1/8"	10 stuks	2.65
2070 1/4-1/4	R1/4"	G1/4"	10 stuks	3.50
2070 3/8-3/8	R3/8"	G3/8"	10 stuks	4.85
2070 1/2-1/2	R1/2"	G1/2"	10 stuks	7.00

Genoemde prijs is per stuk, afname alleen per verpakkingseenheid van 10 stuks.

Series 2000 - draadfittingen



Tee BSPT male/BSP female Sprint®



S2070 1/8-1/8	R1/8"	G1/8"	10 stuks	3.10
S2070 1/4-1/4	R1/4"	G1/4"	10 stuks	3.75
S2070 3/8-3/8	R3/8"	G3/8"	10 stuks	5.20
S2070 1/2-1/2	R1/2"	G1/2"	10 stuks	7.45

Genoemde prijs is per stuk, afname alleen per verpakkingseenheid van 10 stuks.



Tee BSPT male



2080 1/8	R1/8"	10 stuks	2.50
2080 1/4	R1/4"	10 stuks	3.50
2080 3/8	R3/8"	10 stuks	4.85
2080 1/2	R1/2"	10 stuks	7.00
2080 3/4	R3/4"	10 stuks	17.85
2080 1	R1"	10 stuks	25.80

Genoemde prijs is per stuk, afname alleen per verpakkingseenheid van 10 stuks.



Tee BSPT male Sprint®



S2080 1/8	R1/8"	10 stuks	3.20
S2080 1/4	R1/4"	10 stuks	4.75
S2080 3/8	R3/8"	10 stuks	6.70
S2080 1/2	R1/2"	10 stuks	9.30

Genoemde prijs is per stuk, afname alleen per verpakkingseenheid van 10 stuks.

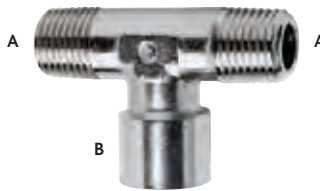

Tee BSPT male/BSP female

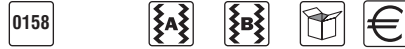

2090 1/8-1/8	R1/8"	G1/8"	10 stuks	2.75
2090 1/4-1/4	R1/4"	G1/4"	10 stuks	3.50
2090 3/8-3/8	R3/8"	G3/8"	10 stuks	4.85
2090 1/2-1/2	R1/2"	G1/2"	10 stuks	7.00
2090 3/4-3/4	R3/4"	G3/8"	10 stuks	17.30
2090 1-1	R1"	G1"	10 stuks	27.35

Genoemde prijs is per stuk, afname alleen per verpakkingseenheid van 10 stuks.

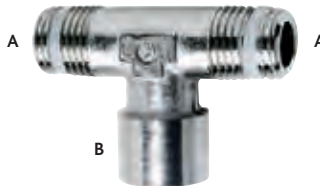

Tee BSPT male/BSP female Sprint®



S2090 1/4-1/4	R1/4"	G1/4"	10 stuks	4.50
S2090 3/8-3/8	R3/8"	G3/8"	10 stuks	6.35
S2090 1/8-1/8	R1/8"	G1/8"	10 stuks	3.35
S2090 1/2-1/2	R1/2"	G1/2"	10 stuks	8.90

Genoemde prijs is per stuk, afname alleen per verpakkingseenheid van 10 stuks.



Borstnippel BSPT male



2500 1/8	R1/8"	10 stuks	0.60
2500 1/4	R1/4"	10 stuks	1.00
2500 3/8	R3/8"	10 stuks	1.45
2500 1/2	R1/2"	10 stuks	2.50
2500 3/4	R3/4"	10 stuks	4.35

Genoemde prijs is per stuk, afname alleen per verpakkingseenheid van 10 stuks.



Borstnippel BSPT male Sprint®



S2500 1/8	R1/8"	10 stuks	1.10
S2500 1/4	R1/4"	10 stuks	1.55
S2500 3/8	R3/8"	10 stuks	2.00
S2500 1/2	R1/2"	10 stuks	3.05

Genoemde prijs is per stuk, afname alleen per verpakkingseenheid van 10 stuks.



Borstnippel BSP male



2501 M5	M5	10 stuks	0.60
2501 1/8	G1/8"	10 stuks	0.70
2501 1/4	G1/4"	10 stuks	1.10
2501 3/8	G3/8"	10 stuks	1.45
2501 1/2	G1/2"	10 stuks	2.75

Genoemde prijs is per stuk, afname alleen per verpakkingseenheid van 10 stuks.

KELM™
pneumatiek

Hydrauliek

Snel-
koppelingen

Afsluiters

Roestvast
staal

Fittingen

Lucht-
conditionering

Gereedschap

Pneumatiek

Diversen

Malleabele
fittingen
& staal

Ringleiding-
systemen

Slangen

Compressoren

Series 2000 - draadfittingen

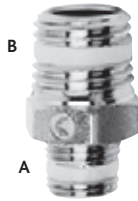

Verloopnippel BSPT male Sprint®

0158				
S2510 1/8-1/4	R1/8"	R1/4"	10 stuks	1.50
S2510 1/8-3/8	R1/8"	R3/8"	10 stuks	1.85
S2510 1/4-3/8	R1/4"	R3/8"	10 stuks	1.85
S2510 1/4-1/2	R1/4"	R1/2"	10 stuks	3.20
S2510 3/8-1/2	R3/8"	R1/2"	10 stuks	3.25
S2510 1/2-3/4	R1/2"	R3/4"	10 stuks	3.40

Genoemde prijs is per stuk, afname alleen per verpakkingseenheid van 10 stuks.

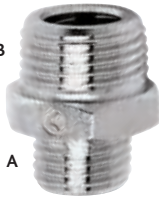

Verloopnippel BSP male

0158				
2511 M5-1/8	M5	G1/8"	10 stuks	0.80
2511 1/8-1/4	G1/8"	G1/4"	10 stuks	0.90
2511 1/8-3/8	G1/8"	G3/8"	10 stuks	1.40
2511 1/4-3/8	G1/4"	G3/8"	10 stuks	1.40
2511 1/4-1/2	G1/4"	G1/2"	10 stuks	2.50
2511 3/8-1/2	G3/8"	G1/2"	10 stuks	2.55

Genoemde prijs is per stuk, afname alleen per verpakkingseenheid van 10 stuks.



Neusstuk BSPT male/BSP female

0158				
2520 1/8-1/8	R1/8"	G1/8"	10 stuks	0.80
2520 1/8-1/4	R1/8"	G1/4"	10 stuks	1.10
2520 1/8-3/8	R1/8"	G3/8"	10 stuks	2.10
2520 1/4-1/4	R1/4"	G1/4"	10 stuks	1.10
2520 1/4-3/8	R1/4"	G3/8"	10 stuks	1.95
2520 1/4-1/2	R1/4"	G1/2"	10 stuks	3.40
2520 3/8-3/8	R3/8"	G3/8"	10 stuks	2.00
2520 3/8-1/2	R3/8"	G1/2"	10 stuks	3.40
2520 1/2-1/2	R1/2"	G1/2"	10 stuks	3.60

Genoemde prijs is per stuk, afname alleen per verpakkingseenheid van 10 stuks.



Neusstuk BSPT male/BSP female Sprint®

0158				
S2520 1/8-1/8	R1/8"	G1/8"	10 stuks	1.00
S2520 1/8-1/4	R1/8"	G1/4"	10 stuks	1.35
S2520 1/8-3/8	R1/8"	G3/8"	10 stuks	2.25
S2520 1/4-1/4	R1/4"	G1/4"	10 stuks	1.60
S2520 1/4-3/8	R1/4"	G3/8"	10 stuks	2.25
S2520 1/4-1/2	R1/4"	G1/2"	10 stuks	3.50
S2520 3/8-3/8	R3/8"	G3/8"	10 stuks	2.40
S2520 3/8-1/2	R3/8"	G1/2"	10 stuks	3.75
S2520 1/2-1/2	R1/2"	G1/2"	10 stuks	3.95

Genoemde prijs is per stuk, afname alleen per verpakkingseenheid van 10 stuks.



Neusstuk BSP male/female

0158				
2521 1/8-1/8	G1/8"	G1/8"	10 stuks	0.75
2521 1/8-1/4	G1/8"	G1/4"	10 stuks	1.10
2521 1/8-3/8	G1/8"	G3/8"	10 stuks	2.25
2521 1/4-1/4	G1/4"	G1/4"	10 stuks	1.20
2521 1/4-3/8	G1/4"	G3/8"	10 stuks	1.95
2521 1/4-1/2	G1/4"	G1/2"	10 stuks	3.25
2521 3/8-3/8	G3/8"	G3/8"	10 stuks	2.05
2521 3/8-1/2	G3/8"	G1/2"	10 stuks	3.40
2521 1/2-1/2	G1/2"	G1/2"	10 stuks	3.70
2521 M5-1/8	M5	G1/8"	10 stuks	0.80

Genoemde prijs is per stuk, afname alleen per verpakkingseenheid van 10 stuks.



Verlengstuk

0158					
2525 1/8-16	G1/8"	16	10 stuks	1.10	
2525 1/8-36	G1/8"	36	10 stuks	1.95	
2525 1/4-27	G1/4"	27	10 stuks	1.90	
2525 1/4-43	G1/4"	43	10 stuks	2.50	

Genoemde prijs is per stuk, afname alleen per verpakkingseenheid van 10 stuks.



Verlooring BSPT male/BSP female

0158				
2530 1/4-1/8	R1/4"	G1/8"	10 stuks	0.70
2530 3/8-1/8	R3/8"	G1/8"	10 stuks	1.00
2530 3/8-1/4	R3/8"	G1/4"	10 stuks	1.00
2530 1/2-1/8	R1/2"	G1/8"	10 stuks	2.10
2530 1/2-1/4	R1/2"	G1/4"	10 stuks	2.00
2530 1/2-3/8	R1/2"	G3/8"	10 stuks	2.00
2530 3/4-3/8	R3/4"	G3/8"	10 stuks	6.90
2530 3/4-1/2	R3/4"	G1/2"	10 stuks	3.25
2530 1-1/2	R1"	G1/2"	10 stuks	12.15

Genoemde prijs is per stuk, afname alleen per verpakkingseenheid van 10 stuks.



Verlooring BSPT male/BSP female Sprint®

0158				
S2530 1/4-1/8	R1/4"	G1/8"	10 stuks	0.90
S2530 3/8-1/8	R3/8"	G1/8"	10 stuks	1.40
S2530 3/8-1/4	R3/8"	G1/4"	10 stuks	1.40
S2530 1/2-1/8	R1/2"	G1/8"	10 stuks	2.55
S2530 1/2-1/4	R1/2"	G1/4"	10 stuks	2.50
S2530 1/2-3/8	R1/2"	G3/8"	10 stuks	2.50

Genoemde prijs is per stuk, afname alleen per verpakkingseenheid van 10 stuks.

Series 2000 - draadfittingen

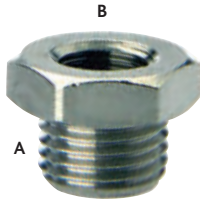

Verloping BSP male/female



0158				€
2531 1/8-M5	G1/8"	M5	10 stuks	0.75
2531 1/4-1/8	G1/4"	G1/8"	10 stuks	0.80
2531 3/8-1/8	G3/8"	G1/8"	10 stuks	1.10
2531 3/8-1/4	G3/8"	G1/4"	10 stuks	1.00
2531 1/2-1/4	G1/2"	G1/4"	10 stuks	2.20
2531 1/2-3/8	G1/2"	G3/8"	10 stuks	2.10
2531 1/2-1/8	G1/2"	G1/8"	10 stuks	2.50

Genoemde prijs is per stuk, afname alleen per verpakkingseenheid van 10 stuks.



Neusstuk draaibaar BSP male/female



0158				€
2541 1/8-1/8	G1/8"	G1/8"	10 stuks	2.65
2541 1/4-1/4	G1/4"	G1/4"	10 stuks	3.25
2541 3/8-3/8	G3/8"	G3/8"	10 stuks	4.70

Genoemde prijs is per stuk, afname alleen per verpakkingseenheid van 10 stuks.



Sok BSP female



0158			€
2543 M5	M5	10 stuks	0.60
2543 1/8	G1/8"	10 stuks	0.70
2543 1/4	G1/4"	10 stuks	1.10
2543 3/8	G3/8"	10 stuks	2.25
2543 1/2	G1/2"	10 stuks	3.65

Genoemde prijs is per stuk, afname alleen per verpakkingseenheid van 10 stuks.



Verloopsok BSP female



0158				€
2553 M5-1/8	M5	G1/8"	10 stuks	0.90
2553 1/8-1/4	G1/8"	G1/4"	10 stuks	1.10
2553 1/8-3/8	G1/8"	G3/8"	10 stuks	2.10
2553 1/8-1/2	G1/8"	G1/2"	10 stuks	3.25
2553 1/4-3/8	G1/4"	G3/8"	10 stuks	2.20
2553 1/4-1/2	G1/4"	G1/2"	10 stuks	3.40
2553 3/8-1/2	G3/8"	G1/2"	10 stuks	3.50

Genoemde prijs is per stuk, afname alleen per verpakkingseenheid van 10 stuks.



Slangpilaar BSP male



0158				€
2601 2-M5	2	M5	10 stuks	1.10
2601 4.5-M5	4,5	M5	10 stuks	0.80
2601 7-1/8	7	G1/8"	10 stuks	0.90
2601 7-1/4	7	G1/4"	10 stuks	1.20
2601 8-1/8	8	G1/8"	10 stuks	0.90
2601 9-1/8	9	G1/8"	10 stuks	0.90
2601 9-1/4	9	G1/4"	10 stuks	1.20
2601 9-3/8	9	G3/8"	10 stuks	1.60
2601 12-1/4	12	G1/4"	10 stuks	1.45
2601 12-3/8	12	G3/8"	10 stuks	1.80
2601 12-1/2	12	G1/2"	10 stuks	2.95
2601 17-3/8	17	G3/8"	10 stuks	1.95
2601 17-1/2	17	G1/2"	10 stuks	3.10

Genoemde prijs is per stuk, afname alleen per verpakkingseenheid van 10 stuks.



Blindstop BSPT male



0158			€
2610 3/4	R3/4"	10 stuks	3.55

Genoemde prijs is per stuk, afname alleen per verpakkingseenheid van 10 stuks.



Blindstop BSP male O-ring



0158			€
2612 M7	M7	10 stuks	0.55
2610 1/8	G1/8"	10 stuks	0.90
2610 1/4	G1/4"	10 stuks	1.10
2610 3/8	G3/8"	10 stuks	1.35
2610 1/2	G1/2"	10 stuks	2.20

Genoemde prijs is per stuk, afname alleen per verpakkingseenheid van 10 stuks.



Blindstop BSP male



0158			€
2611 M5	M5	10 stuks	0.50
2611 1/8	G1/8"	10 stuks	0.60
2611 1/4	G1/4"	10 stuks	0.90
2611 3/8	G3/8"	10 stuks	1.20
2611 1/2	G1/2"	10 stuks	2.35
2611 1	G1"	10 stuks	7.20

Genoemde prijs is per stuk, afname alleen per verpakkingseenheid van 10 stuks.



Blindkap BSP female



0158			€
2613 1/8	G1/8"	10 stuks	0.60
2613 1/4	G1/4"	10 stuks	0.90
2613 3/8	G3/8"	10 stuks	1.50
2613 1/2	G1/2"	10 stuks	2.30

Genoemde prijs is per stuk, afname alleen per verpakkingseenheid van 10 stuks.

KELM™
pneumatiek

Hydrauliek

Snel-
koppelingen

Afsluiters

Roestvast
staal

Fittingen

Lucht-
conditionering

Gereedschap

Pneumatiek

Diversen

Malleabele
fittingen
& staal

Ringleiding-
systemen

Slangen

Compressoren

Series 2000 - draadfittingen



Blindstop Spruit

0158			€
S2615 1/8	G1/8"	10 stuks	0.90
S2615 1/4	G1/4"	10 stuks	1.10
S2615 3/8	G3/8"	10 stuks	1.35

Genoemde prijs is per stuk, afname alleen per verpakkingseenheid van 10 stuks.



Aluminium afdichtringen

0158			€
2651 1/8	1/8"	100 stuks	0.10
2651 1/4	1/4"	100 stuks	0.10
2651 3/8	3/8"	100 stuks	0.15
2651 1/2	1/2"	100 stuks	0.30
2651 1	1"	100 stuks	0.90

Genoemde prijs is per stuk, afname alleen per verpakkingseenheid van 100 stuks.



Nylon afdichtringen - type 2661

0158			€
2661 M5	M5	100 stuks	0.10
2661 M6	M6	100 stuks	0.10
2661 1/8	1/8"	100 stuks	0.10
2661 1/4	1/4"	100 stuks	0.10
2661 3/8	3/8"	100 stuks	0.20
2661 1/2	1/2"	100 stuks	0.20

Genoemde prijs is per stuk, afname alleen per verpakkingseenheid van 100 stuks.



Nylon afdichtringen

0158			€
2665 1/8	1/8"	100 stuks	0.20
2665 1/4	1/4"	100 stuks	0.20
2665 3/8	3/8"	100 stuks	0.25
2665 1/2	1/2"	100 stuks	0.40

Genoemde prijs is per stuk, afname alleen per verpakkingseenheid van 100 stuks.



Nylon afdichtringen

0158			€
2669 1/8	1/8"	100 stuks	0.40
2669 1/4	1/4"	100 stuks	0.40
2669 3/8	3/8"	100 stuks	0.50
2669 1/2	1/2"	100 stuks	0.50

Genoemde prijs is per stuk, afname alleen per verpakkingseenheid van 100 stuks.



Verdeelblok

0158			€
3033 1/8	G1/8"	10 stuks	4.95
3033 1/4	G1/4"	10 stuks	7.60
3033 3/8	G3/8"	10 stuks	11.70
3033 1/2	G1/2"	10 stuks	14.55

Genoemde prijs is per stuk, afname alleen per verpakkingseenheid van 10 stuks.

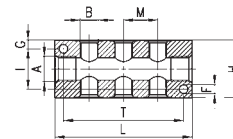

Verdeelblok - enkel

0158				€
3043 1/4-3D-1/8	G1/4"	3x	G1/8"	20.50
3043 1/4-4D-1/8	G1/4"	4x	G1/8"	23.55
3043 1/4-5D-1/8	G1/4"	5x	G1/8"	26.90
3043 1/4-6D-1/8	G1/4"	6x	G1/8"	30.30
3043 3/8-3D-1/4	G3/8"	3x	G1/4"	24.80
3043 3/8-4D-1/4	G3/8"	4x	G1/4"	28.95
3043 3/8-5D-1/4	G3/8"	5x	G1/4"	33.50
3043 3/8-6D-1/4	G3/8"	6x	G1/4"	37.75
3043 1/2-3D-3/8	G1/2"	3x	G3/8"	30.00
3043 1/2-4D-3/8	G1/2"	4x	G3/8"	36.30
3043 1/2-5D-3/8	G1/2"	5x	G3/8"	42.35
3043 1/2-6D-3/8	G1/2"	6x	G3/8"	46.40

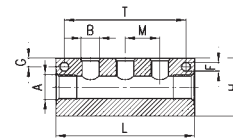

Verdeelblok - dubbel

0158				€
3053 1/4-3L-1/8	G1/4"	3x	G1/8"	17.15
3053 1/4-4L-1/8	G1/4"	4x	G1/8"	19.15
3053 1/4-5L-1/8	G1/4"	5x	G1/8"	21.40
3053 1/4-6L-1/8	G1/4"	6x	G1/8"	23.75
3053 3/8-3L-1/4	G3/8"	3x	G1/4"	21.55
3053 3/8-4L-1/4	G3/8"	4x	G1/4"	24.60
3053 3/8-5L-1/4	G3/8"	5x	G1/4"	28.05
3053 3/8-6L-1/4	G3/8"	6x	G1/4"	31.15
3053 1/2-3L-3/8	G1/2"	3x	G3/8"	25.45
3053 1/2-4L-3/8	G1/2"	4x	G3/8"	27.45
3053 1/2-5L-3/8	G1/2"	5x	G3/8"	32.10
3053 1/2-6L-3/8	G1/2"	6x	G3/8"	34.90

Series 6000 - Super Rapid - push-in koppelingen

- Afsluitgarantie
- Gepatendeerde afdichting Sprint®
- Zeer korte draad
- Minimale drukval
- Ook voor vacuüm

Materiaal
Messing vernikkeld

Draad
Metrisch - M3, M5, M7
GAS, conisch ISO 7 (BSPT) GAS,
Cilindrisch ISO 228 (BSP)



Maximale werkdruk:
-0,8 ÷ 16 bar



Kniekoppeling 45° - inschroef draaibaar Sprint®

0158	OD mm			€
S6110 6-1/8	6	G1/8"	10 stuks	6.60
S6110 6-1/4	6	G1/4"	10 stuks	6.60
S6110 8-1/8	8	G1/8"	10 stuks	7.00
S6110 8-1/4	8	G1/4"	10 stuks	7.00
S6110 8-3/8	8	G3/8"	10 stuks	7.90
S6110 10-1/4	10	G1/4"	10 stuks	9.65
S6110 10-3/8	10	G3/8"	10 stuks	9.65
S6110 10-1/2	10	G1/2"	10 stuks	10.85
S6110 12-1/4	12	G1/4"	10 stuks	12.30
S6110 12-3/8	12	G3/8"	10 stuks	12.30
S6110 12-1/2	12	G1/2"	10 stuks	13.20

Genoemde prijs is per stuk, afname alleen per verpakkingseenheid van 10 stuks.



Tee koppeling - inschroef draaibaar Sprint®

0158	OD mm			€
S6430 6-1/8	6	G1/8"	10 stuks	4.20
S6430 10-1/2	10	G1/2"	10 stuks	8.20
S6430 6-1/4	6	G1/4"	10 stuks	4.50
S6430 4-1/8	4	G1/8"	10 stuks	4.50
S6430 8-1/8	8	G1/8"	10 stuks	5.25
S6430 8-1/4	8	G1/4"	10 stuks	5.40
S6430 8-3/8	8	G3/8"	10 stuks	6.05
S6430 10-1/4	10	G1/4"	10 stuks	6.95
S6430 12-1/4	12	G1/4"	10 stuks	7.60
S6430 12-1/2	12	G1/2"	10 stuks	9.15
S6430 14-3/8	14	G3/8"	10 stuks	11.15
S6430 14-1/2	14	G1/2"	10 stuks	11.30
S6430 5-1/8	5	G1/8"	10 stuks	4.50
S6430 10-3/8	10	G3/8"	10 stuks	7.45
S6430 12-3/8	12	G3/8"	10 stuks	8.00
S6430 5-1/4	5	G1/4"	10 stuks	4.90

Genoemde prijs is per stuk, afname alleen per verpakkingseenheid van 10 stuks.



Tee koppeling - inschroef draaibaar O-ring

0158	OD mm			€
6432 3-M3	3	M3	10 stuks	7.45
6432 3-M5	3	M5	10 stuks	6.75
6432 4-M5	4	M5	10 stuks	4.00
6432 5-M5	5	M5	10 stuks	4.00
6432 4-1/8	4	G1/8"	10 stuks	4.35
6432 6-1/8	6	G1/8"	10 stuks	4.40
6432 6-1/4	6	G1/4"	10 stuks	4.70
6432 8-1/8	8	G1/8"	10 stuks	5.40
6432 8-1/4	8	G1/4"	10 stuks	5.50
6432 8-3/8	8	G3/8"	10 stuks	6.15
6432 10-1/4	10	G1/4"	10 stuks	7.15
6432 10-3/8	10	G3/8"	10 stuks	7.60
6432 12-1/4	12	G1/4"	10 stuks	8.00
6432 12-3/8	12	G3/8"	10 stuks	8.55

Genoemde prijs is per stuk, afname alleen per verpakkingseenheid van 10 stuks.



Zij-tee koppeling - inschroef draaibaar Sprint®

0158	OD mm			€
S6440 4-1/8	4	G1/8"	10 stuks	4.50
S6440 5-1/8	5	G1/8"	10 stuks	4.50
S6440 6-1/8	6	G1/8"	10 stuks	4.20
S6440 6-1/4	6	G1/4"	10 stuks	4.50
S6440 8-1/8	8	G1/8"	10 stuks	5.25
S6440 8-1/4	8	G1/4"	10 stuks	5.40
S6440 8-3/8	8	G3/8"	10 stuks	6.05
S6440 10-1/4	10	G1/4"	10 stuks	6.95
S6440 10-3/8	10	G3/8"	10 stuks	7.45
S6440 12-3/8	12	G3/8"	10 stuks	8.00
S6440 14-1/2	14	G1/2"	10 stuks	11.30

Genoemde prijs is per stuk, afname alleen per verpakkingseenheid van 10 stuks.



Zij-tee koppeling - inschroef draaibaar

0158	OD mm			€
6442 3-M3	3	M3	10 stuks	7.45
6442 3-M5	3	M5	10 stuks	6.75
6442 4-M5	4	M5	10 stuks	4.00
6442 4-1/8	4	G1/8"	10 stuks	4.35
6442 5-M5	5	M5	10 stuks	4.00
6442 6-1/8	6	G1/8"	10 stuks	4.40
6442 6-1/4	6	G1/4"	10 stuks	4.70
6442 8-1/8	8	G1/8"	10 stuks	5.40
6442 8-1/4	8	G1/4"	10 stuks	5.50
6442 8-3/8	8	G3/8"	10 stuks	6.15
6442 10-1/4	10	G1/4"	10 stuks	7.15
6442 10-3/8	10	G3/8"	10 stuks	7.60
6442 12-1/4	12	G1/4"	10 stuks	8.00
6442 12-3/8	12	G3/8"	10 stuks	8.55

Genoemde prijs is per stuk, afname alleen per verpakkingseenheid van 10 stuks.



Y-koppeling - inschroef Sprint®

0158	OD mm			€
S6450 4-1/8	4	G1/8"	10 stuks	5.25
S6450 6-1/8	6	G1/8"	10 stuks	5.50
S6450 8-1/8	8	G1/8"	10 stuks	6.60
S6450 8-1/4	8	G1/4"	10 stuks	6.60

Genoemde prijs is per stuk, afname alleen per verpakkingseenheid van 10 stuks.

KELM™
pneumatiek

Hydrauliek

Snel-
koppelingen

Afsluiters

Roestvast
staal

Fittingen

Lucht-
conditionering

Gereedschap

Pneumatiek

Diversen

Malleabele
fittingen
& staal

Ringleiding-
systemen

Slangen

Compressoren

Series 6000 - Super Rapid - push-in koppelingen



Rechte koppeling - opschroef

0158	OD mm			€
6463 4-M5	4	M5	10 stuks	2.20
6463 4-1/8	4	G1/8"	10 stuks	2.05
6463 5-1/8	5	G1/8"	10 stuks	2.05
6463 6-1/8	6	G1/8"	10 stuks	2.05
6463 6-1/4	6	G1/4"	10 stuks	2.40
6463 8-1/8	8	G1/8"	10 stuks	2.40
6463 8-1/4	8	G1/4"	10 stuks	2.50
6463 10-1/4	10	G1/4"	10 stuks	2.95

Genoemde prijs is per stuk, afname alleen per verpakkingseenheid van 10 stuks.



Kniekoppeling - inschroef Sprint®

0158	OD mm			€
S6500 4-1/8	4	G1/8"	10 stuks	2.20
S6500 4-1/4	4	G1/4"	10 stuks	2.45
S6500 5-1/8	5	G1/8"	10 stuks	2.20
S6500 5-1/4	5	G1/4"	10 stuks	2.45
S6500 6-1/8	6	G1/8"	10 stuks	2.20
S6500 6-1/4	6	G1/4"	10 stuks	2.45
S6500 8-1/8	8	G1/8"	10 stuks	2.55
S6500 8-1/4	8	G1/4"	10 stuks	2.65
S6500 8-3/8	8	G3/8"	10 stuks	3.15
S6500 10-1/4	10	G1/4"	10 stuks	3.75
S6500 10-3/8	10	G3/8"	10 stuks	3.95
S6500 12-1/4	12	G1/4"	10 stuks	4.60
S6500 12-3/8	12	G3/8"	10 stuks	4.60

Genoemde prijs is per stuk, afname alleen per verpakkingseenheid van 10 stuks.



Kniekoppeling - inschroef rode ring

0158	OD mm			€
6501 4-M5	4	M5	10 stuks	2.65

Genoemde prijs is per stuk, afname alleen per verpakkingseenheid van 10 stuks.



Rechte koppeling - inschroef Sprint®

0158	OD mm			€
S6510 4-1/8	4	G1/8"	10 stuks	1.40
S6510 4-1/4	4	G1/4"	10 stuks	1.60
S6510 5-1/8	5	G1/8"	10 stuks	1.40
S6510 5-1/4	5	G1/4"	10 stuks	1.60
S6510 6-1/8	6	G1/8"	10 stuks	1.40
S6510 6-1/4	6	G1/4"	10 stuks	1.60
S6510 6-3/8	6	G3/8"	10 stuks	2.40
S6510 8-1/8	8	G1/8"	10 stuks	1.75
S6510 8-1/4	8	G1/4"	10 stuks	1.80
S6510 8-3/8	8	G3/8"	10 stuks	2.10
S6510 8-1/2	8	G1/2"	10 stuks	3.25
S6510 10-1/4	10	G1/4"	10 stuks	2.45
S6510 10-3/8	10	G3/8"	10 stuks	2.45
S6510 10-1/2	10	G1/2"	10 stuks	3.35
S6510 12-1/4	12	G1/4"	10 stuks	2.95
S6510 12-1/2	12	G1/2"	10 stuks	3.75
S6510 12-3/8	12	G3/8"	10 stuks	2.95
S6510 14-3/8	14	G3/8"	10 stuks	4.25
S6510 14-1/2	14	G1/2"	10 stuks	4.25
S6510 16-1/4	16	G1/4"	10 stuks	8.35
S6510 16-3/4	16	G3/4"	10 stuks	11.25

Genoemde prijs is per stuk, afname alleen per verpakkingseenheid van 10 stuks.



Rechte koppeling - inschroef O-ring

0158	OD mm			€
6512 3-M3	3	M3	10 stuks	3.50
6512 3-M5	3	M5	10 stuks	3.00
6512 4-M5	4	M5	10 stuks	1.60
6512 4-1/8	4	G1/8"	10 stuks	1.55
6512 4-1/8-M	4	G1/8"	10 stuks	1.55
6512 4-M6	4	M6	10 stuks	1.60
6512 4-1/4	4	G1/4"	10 stuks	1.85
6512 5-M5	5	M5	10 stuks	1.60
6512 6-M5	6	M5	10 stuks	1.60
6512 6-1/8	6	G1/8"	10 stuks	1.55
6512 6-1/8-M	6	G1/8"	10 stuks	1.55
6512 6-M7	6	M7	10 stuks	1.80
6512 6-1/4	6	G1/4"	10 stuks	1.85
6512 8-1/8	8	G1/8"	10 stuks	1.85
6512 8-1/8-M	8	G1/8"	10 stuks	1.85
6512 8-1/4	8	G1/4"	10 stuks	1.95
6512 8-3/8	8	G3/8"	10 stuks	2.25
6512 10-1/4	10	G1/4"	10 stuks	2.65
6512 10-3/8	10	G3/8"	10 stuks	2.65
6512 12-1/4	12	G1/4"	10 stuks	2.95
6512 12-3/8	12	G3/8"	10 stuks	3.15

Genoemde prijs is per stuk, afname alleen per verpakkingseenheid van 10 stuks.



Kniekoppeling - inschroef draaibaar Sprint®

0158	OD mm			€
S6520 4-1/4	4	G1/4"	10 stuks	3.00
S6520 4-1/8	4	G1/8"	10 stuks	2.85
S6520 5-1/8	5	G1/8"	10 stuks	2.85
S6520 5-1/4	5	G1/4"	10 stuks	3.15
S6520 6-1/8	6	G1/8"	10 stuks	2.85
S6520 6-1/4	6	G1/4"	10 stuks	3.15
S6520 6-3/8	6	G3/8"	10 stuks	4.85
S6520 8-1/8	8	G1/8"	10 stuks	3.35
S6520 8-1/4	8	G1/4"	10 stuks	3.50
S6520 8-3/8	8	G3/8"	10 stuks	4.50
S6520 8-1/2	8	G1/2"	10 stuks	6.00
S6520 10-1/4	10	G1/4"	10 stuks	4.70
S6520 10-3/8	10	G3/8"	10 stuks	4.85
S6520 10-1/2	10	G1/2"	10 stuks	6.05
S6520 12-1/4	12	G1/4"	10 stuks	5.40
S6520 12-3/8	12	G3/8"	10 stuks	5.80
S6520 12-1/2	12	G1/2"	10 stuks	6.95
S6520 14-3/8	14	G3/8"	10 stuks	7.80
S6520 14-1/2	14	G1/2"	10 stuks	8.00

Genoemde prijs is per stuk, afname alleen per verpakkingseenheid van 10 stuks.



Kniekoppeling - inschroef draaibaar O-Ring

0158	OD mm			€
6522 3-M3	3	M3	10 stuks	5.40
6522 3-M5	3	M5	10 stuks	4.85
6522 4-M5	4	M5	10 stuks	3.25
6522 4-1/8	4	G1/8"	10 stuks	3.05
6522 4-1/4	4	G1/4"	10 stuks	3.50
6522 5-M5	5	M5	10 stuks	3.25
6522 5-1/8	5	G1/8"	10 stuks	3.05
6522 6-M5	6	M5	10 stuks	3.25
6522 6-1/8	6	G1/8"	10 stuks	3.05
6522 6-1/4	6	G1/4"	10 stuks	3.50
6522 8-1/8	8	G1/8"	10 stuks	3.60
6522 8-1/4	8	G1/4"	10 stuks	3.70
6522 8-3/8	8	G3/8"	10 stuks	4.95
6522 10-1/4	10	G1/4"	10 stuks	5.15
6522 10-3/8	10	G3/8"	10 stuks	5.15
6522 12-1/4	12	G1/4"	10 stuks	5.80
6522 12-3/8	12	G3/8"	10 stuks	6.05

Genoemde prijs is per stuk, afname alleen per verpakkingseenheid van 10 stuks.

Series 6000 - Super Rapid - push-in koppelingen



Verhoogde kniekoppeling - inschroef Sprint®

0158	OD mm			€
6525 6-1/8	6	G1/8"	10 stuks	4.00
6525 6-1/4	6	G1/4"	10 stuks	5.00
6525 8-1/8	8	G1/8"	10 stuks	4.50
6525 8-1/4	8	G1/4"	10 stuks	5.25

Genoemde prijs is per stuk, afname alleen per verpakkingseenheid van 10 stuks.



Tee koppeling

0158	OD mm			€
6540 3	3		10 stuks	6.55
6540 4	4		10 stuks	3.70
6540 5	5		10 stuks	3.70
6540 6	6		10 stuks	3.70
6540 8	8		10 stuks	4.50
6540 10	10		10 stuks	6.45
6540 12	12		10 stuks	8.00
6540 14	14		10 stuks	10.75

Genoemde prijs is per stuk, afname alleen per verpakkingseenheid van 10 stuks.



Kniefkoppeling

0158	OD mm			€
6550 3	3		10 stuks	4.70
6550 4	4		10 stuks	2.75
6550 5	5		10 stuks	2.85
6550 6	6		10 stuks	2.85
6550 8	8		10 stuks	3.35
6550 10	10		10 stuks	4.60
6550 12	12		10 stuks	6.10
6550 14	14		10 stuks	7.80

Genoemde prijs is per stuk, afname alleen per verpakkingseenheid van 10 stuks.



Kniefkoppeling

0158	OD mm			€
6555 4-4	4		10 stuks	3.55
6555 6-6	6		10 stuks	3.55
6555 8-8	8		10 stuks	3.80
6555 10-10	10		10 stuks	6.15

Genoemde prijs is per stuk, afname alleen per verpakkingseenheid van 10 stuks.



Y-koppeling

0158	OD mm			€
6560 3	3		10 stuks	8.85
6560 4	4		10 stuks	6.00
6560 6	6		10 stuks	6.00
6560 8	8		10 stuks	7.25
6560 10	10		10 stuks	12.35

Genoemde prijs is per stuk, afname alleen per verpakkingseenheid van 10 stuks.



Rechte koppeling (gelijk en verlopend)

0158	OD mm			€
6580 3	3	-	10 stuks	4.95
6580 4	4	-	10 stuks	2.40
6580 5	5	-	10 stuks	2.40
6580 6	6	-	10 stuks	2.40
6580 6-4	6	4 mm	10 stuks	2.85
6580 8	8	-	10 stuks	2.85
6580 8-6	8	6 mm	10 stuks	3.20
6580 10	10	-	10 stuks	3.55
6580 10-8	10	8 mm	10 stuks	3.85
6580 12	12	-	10 stuks	3.80
6580 12-10	12	10 mm	10 stuks	4.10
6580 14	14	-	10 stuks	6.65

Genoemde prijs is per stuk, afname alleen per verpakkingseenheid van 10 stuks.



Schotdoorvoerkoppeling - opschroef

0158	OD mm			€
6593 6-1/8	6	G1/8"	10 stuks	8.75
6593 6-1/4	6	G1/4"	10 stuks	9.65
6593 8-1/8	8	G1/8"	10 stuks	9.65
6593 8-1/4	8	G1/4"	10 stuks	10.55
6593 10-3/8	10	G3/8"	10 stuks	14.55

Genoemde prijs is per stuk, afname alleen per verpakkingseenheid van 10 stuks.



Schotdoorvoerkoppeling

0158	OD mm			€
6590 3	3		10 stuks	7.45
6590 4	4		10 stuks	3.90
6590 5	5		10 stuks	3.90
6590 6	6		10 stuks	3.90
6590 8	8		10 stuks	4.35
6590 10	10		10 stuks	5.80
6590 12	12		10 stuks	6.75
6590 14	14		10 stuks	9.55

Genoemde prijs is per stuk, afname alleen per verpakkingseenheid van 10 stuks.



Kruiskoppeling

0158	OD mm			€
6600 4	4		10 stuks	6.65
6600 5	5		10 stuks	6.65
6600 6	6		10 stuks	6.65
6600 8	8		10 stuks	7.55
6600 10	10		10 stuks	9.90
6600 12	12		10 stuks	13.95

Genoemde prijs is per stuk, afname alleen per verpakkingseenheid van 10 stuks.

- KELM™ pneumatiek
- Hydrauliek
- Snelkoppelingen
- Afsluiters
- Roestvast staal
- Fittingen
- Luchtconditionering
- Gereedschap
- Pneumatiek
- Diversen
- Malleabele fittingen & staal
- Ringleidingssystemen
- Slangen
- Compressoren

Series 6000 - Super Rapid - push-in koppelingen



Banjo enkel

0158	OD mm			€
6610 4-M5	4	M5	10 stuks	2.10
6610 4-M6	4	M6	10 stuks	2.10
6610 4-1/8	4	G1/8"	10 stuks	2.65
6610 5-M5	5	M5	10 stuks	2.10
6610 5-M6	5	M6	10 stuks	2.10
6610 5-1/8	5	G1/8"	10 stuks	2.65
6610 6-M5	6	M5	10 stuks	2.65
6610 6-M6	6	M6	10 stuks	2.65
6610 6-1/8	6	G1/8"	10 stuks	2.65
6610 6-1/4	6	G1/4"	10 stuks	2.95
6610 8-1/8	8	G1/8"	10 stuks	3.05
6610 8-1/4	8	G1/4"	10 stuks	3.25
6610 8-3/8	8	G3/8"	10 stuks	3.60
6610 10-1/4	10	G1/4"	10 stuks	3.65
6610 10-3/8	10	G3/8"	10 stuks	4.00
6610 12-1/2	12	G1/2"	10 stuks	6.35

Genoemde prijs is per stuk, afname alleen per verpakkingseenheid van 10 stuks.



Banjokoppeling - inschroef

0158	OD mm			€
6621 3-M3	3	M3	10 stuks	6.75
6621 3-M5	3	M5	10 stuks	6.15

Genoemde prijs is per stuk, afname alleen per verpakkingseenheid van 10 stuks.



Banjo enkel+bout inbus - inschroef O-ring

0158	OD mm			€
6622 4-M5	4	M5	10 stuks	5.65
6622 4-1/8	4	G1/8"	10 stuks	5.65
6622 6-1/8	6	G1/8"	10 stuks	5.65
6622 6-1/4	6	G1/4"	10 stuks	6.25
6622 8-1/8	8	G1/8"	10 stuks	5.90
6622 8-1/4	8	G1/4"	10 stuks	6.35
6622 10-1/4	10	G1/4"	10 stuks	6.95

Genoemde prijs is per stuk, afname alleen per verpakkingseenheid van 10 stuks.



Banjo dubbel+bout inbus inschroef - O-ring

0158	OD mm			€
6632 4-1/8	4	G1/8"	10 stuks	8.00
6632 6-1/8	6	G1/8"	10 stuks	8.00
6632 6-1/4	6	G1/4"	10 stuks	8.75
6632 8-1/8	8	G1/8"	10 stuks	8.35
6632 8-1/4	8	G1/4"	10 stuks	9.00
6632 10-1/4	10	G1/4"	10 stuks	9.60

Genoemde prijs is per stuk, afname alleen per verpakkingseenheid van 10 stuks.



Koppeling insert

0158	OD mm			€
6700 3	3		10 stuks	2.40
6700 4	4		10 stuks	1.50
6700 5	5		10 stuks	1.50
6700 6	6		10 stuks	1.50
6700 8	8		10 stuks	1.70
6700 10	10		10 stuks	1.95
6700 12	12		10 stuks	2.25

Genoemde prijs is per stuk, afname alleen per verpakkingseenheid van 10 stuks.



Slangafsluiter

0158	OD mm			€
6750 4	4		10 stuks	1.50
6750 6	6		10 stuks	1.50
6750 8	8		10 stuks	1.70
6750 10	10		10 stuks	1.95
6750 12	12		10 stuks	2.25

Genoemde prijs is per stuk, afname alleen per verpakkingseenheid van 10 stuks.

Series 6000 - Super Rapid - push-in koppelingen



Leidingverloop

0158	OD mm	Stem OD mm		€
6800 3-4	3	4	10 stuks	3.75
6800 4-5	4	5	10 stuks	1.75
6800 4-6	4	6	10 stuks	1.75
6800 4-8	4	8	10 stuks	1.85
6800 5-6	5	6	10 stuks	1.75
6800 5-8	5	8	10 stuks	1.85
6800 6-8	6	8	10 stuks	1.90
6800 6-10	6	10	10 stuks	2.05
6800 6-12	6	12	10 stuks	2.20
6800 8-10	8	10	10 stuks	2.40
6800 8-12	8	12	10 stuks	2.40
6800 10-12	10	12	10 stuks	2.50
6800 10-14	10	14	10 stuks	2.95
6800 12-14	12	14	10 stuks	3.25

Genoemde prijs is per stuk, afname alleen per verpakkingseenheid van 10 stuks.



Steelekoppeling - inschroef Sprint®

0158	OD mm			€
6811 4-M5	4	M5	10 stuks	1.10
6811 4-1/8	4	G1/8"	10 stuks	1.30
6811 5-1/8	5	G1/8"	10 stuks	1.30
6811 5-1/4	5	G1/4"	10 stuks	1.60
6811 6-1/8	6	G1/8"	10 stuks	1.30
6811 6-1/4	6	G1/4"	10 stuks	1.60
6811 8-1/8	8	G1/8"	10 stuks	1.30
6811 8-1/4	8	G1/4"	10 stuks	1.60
6811 10-1/4	10	G1/4"	10 stuks	1.70
6811 10-3/8	10	G3/8"	10 stuks	2.25
6811 12-3/8	12	G3/8"	10 stuks	2.25
6811 14-1/2	14	G1/2"	10 stuks	3.80

Genoemde prijs is per stuk, afname alleen per verpakkingseenheid van 10 stuks.



Leidingverloop

0158	OD mm	Stem OD mm		€
6850 6-4	6	4	10 stuks	1.75
6850 8-6	8	6	10 stuks	1.90

Genoemde prijs is per stuk, afname alleen per verpakkingseenheid van 10 stuks.



Afsluitplug

0158	OD mm		€
6900 3	3	10 stuks	0.75
6900 4	4	10 stuks	0.40
6900 5	5	10 stuks	0.40
6900 6	6	10 stuks	0.40
6900 8	8	10 stuks	0.40
6900 10	10	10 stuks	0.50
6900 12	12	10 stuks	0.60
6900 14	14	10 stuks	0.75

Genoemde prijs is per stuk, afname alleen per verpakkingseenheid van 10 stuks.



Verbindingspijp

0158	OD mm		€
6950 4	4	10 stuks	1.00
6950 5	5	10 stuks	1.00
6950 6	6	10 stuks	1.00
6950 8	8	10 stuks	1.00
6950 10	10	10 stuks	1.40
6950 12	12	10 stuks	1.60
6950 14	14	10 stuks	2.10

Genoemde prijs is per stuk, afname alleen per verpakkingseenheid van 10 stuks.

KELM™
pneumatiek

Hydrauliek

Snel-
koppelingen

Afsluiters

Roestvast
staal

Fittingen

Lucht-
conditionering

Gereedschap

Pneumatiek

Diversen

Malleabele
fittingen
& staal

Ringleiding-
systemen

Slangen

Compressoren

Series 7000 - Super Rapid COMPACT - insteekkoppelingen

- Lichtgewicht
- Hoogwaardig polymer
- Recyclebaar
- Minimale drukval
- Ook voor vacuüm

Materiaal
Body technopolymer,
spantang messing-vernikkeld

Draad
GAS cilindrisch
ISO 228 (BSP)

Temperatuur:
-20°C ÷ 60°C

Maximale werkdruk:
-0,9 ÷ 16 bar

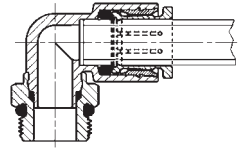

Tee koppeling - inschroef draaibaar
O-ring

0158	OD mm			€
7432 4-M5	4	M5	10 stuks	4.00
7432 4-1/8	4	G1/8"	10 stuks	3.85
7432 6-M5	6	M5	10 stuks	4.00
7432 6-1/8	6	G1/8"	10 stuks	3.70
7432 6-1/4	6	G1/4"	10 stuks	3.95
7432 8-1/8	8	G1/8"	10 stuks	4.35
7432 8-1/4	8	G1/4"	10 stuks	4.60
7432 8-3/8	8	G3/8"	10 stuks	4.90
7432 10-1/4	10	G1/4"	10 stuks	5.10
7432 10-3/8	10	G3/8"	10 stuks	5.60

Genoemde prijs is per stuk, afname alleen per verpakkingseenheid van 10 stuks.



Kniekoppeling - inschroef draaibaar

0158	OD mm			€
7522 4-M5	4	M5	10 stuks	2.50
7522 4-M7	4	M7	10 stuks	3.15
7522 4-1/8	4	G1/8"	10 stuks	2.50
7522 4-1/4	4	G1/4"	10 stuks	2.55
7522 6-M5	6	M5	10 stuks	2.50
7522 6-M7	6	M7	10 stuks	3.15
7522 6-1/8	6	G1/8"	10 stuks	2.50
7522 6-1/4	6	G1/4"	10 stuks	2.75
7522 8-1/8	8	G1/8"	10 stuks	2.75
7522 8-1/4	8	G1/4"	10 stuks	2.75
7522 8-3/8	8	G3/8"	10 stuks	3.45
7522 10-1/4	10	G1/4"	10 stuks	3.15
7522 10-3/8	10	G3/8"	10 stuks	3.50
7522 10-1/2	10	G1/2"	10 stuks	4.90

Genoemde prijs is per stuk, afname alleen per verpakkingseenheid van 10 stuks.



Verhoogde kniekoppeling - inschroef draaibaar

0158	OD mm			€
7526 4-1/8	4	G1/8"	10 stuks	3.50
7526 6-1/8	6	G1/8"	10 stuks	3.35
7526 6-1/4	6	G1/4"	10 stuks	4.00
7526 8-1/8	8	G1/8"	10 stuks	3.70
7526 8-1/4	8	G1/4"	10 stuks	4.20

Genoemde prijs is per stuk, afname alleen per verpakkingseenheid van 10 stuks.



Tee koppeling

0158	OD mm			€
7540 4	4		10 stuks	3.35
7540 6	6		10 stuks	3.50
7540 8	8		10 stuks	4.00
7540 10	10		10 stuks	4.50

Genoemde prijs is per stuk, afname alleen per verpakkingseenheid van 10 stuks.

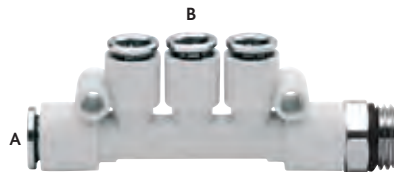

Tee multiverloop - inschroef draaibaar

0158	OD A mm	OD B mm		€
7542 6-4-1/8	6	3x 4 mm	G1/8" 10 stuks	9.10
7542 6-4-1/4	6	3x 4 mm	G1/4" 10 stuks	9.25
7542 8-6-1/8	8	3x 6 mm	G1/8" 10 stuks	9.85
7542 8-6-1/4	8	3x 6 mm	G1/4" 10 stuks	9.95
7542 10-8-1/4	10	3x 8 mm	G1/4" 10 stuks	12.75
7542 10-8-3/8	10	3x 8 mm	G3/8" 10 stuks	13.05

Genoemde prijs is per stuk, afname alleen per verpakkingseenheid van 10 stuks.

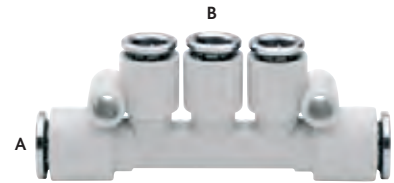

Tee multiverloop

0158	OD A mm	OD B mm		€
7545 6-4	6	3x 4 mm	10 stuks	7.90
7545 8-6	6	3x 6 mm	10 stuks	8.60
7545 10-8	10	3x 8 mm	10 stuks	12.45

Genoemde prijs is per stuk, afname alleen per verpakkingseenheid van 10 stuks.



Kniekoppeling

0158	OD mm			€
7550 4	4		10 stuks	2.75
7550 6	6		10 stuks	2.75
7550 8	8		10 stuks	2.95
7550 10	10		10 stuks	3.70

Genoemde prijs is per stuk, afname alleen per verpakkingseenheid van 10 stuks.



Y-koppeling (gelijk en verlopend)

0158	OD A mm	OD B mm		€
7560 4	4	-	10 stuks	3.85
7560 6	6	-	10 stuks	3.85
7560 8	8	-	10 stuks	4.50
7560 10	10	-	10 stuks	7.70
7560 6-4	6	4 mm	10 stuks	5.80
7560 8-6	8	6 mm	10 stuks	6.60
7560 10-8	10	8 mm	10 stuks	8.95

Genoemde prijs is per stuk, afname alleen per verpakkingseenheid van 10 stuks.

Series 7000 - Super Rapid COMPACT - insteekkoppelingen



Y-koppeling - inschroef draaibaar

0158	OD mm				€
7562 4-1/8	4	G1/8"	10 stuks		4.75
7562 6-1/8	6	G1/8"	10 stuks		4.90
7562 6-1/4	6	G1/4"	10 stuks		5.25
7562 8-1/8	8	G1/8"	10 stuks		5.60
7562 8-1/4	8	G1/4"	10 stuks		5.95
7562 10-1/4	10	G1/4"	10 stuks		7.35
7562 10-3/8	10	G3/8"	10 stuks		7.90

Genoemde prijs is per stuk, afname alleen per verpakkingseenheid van 10 stuks.



Y-koppeling - inschroef 4-voudig draaibaar

0158	OD mm				€
7572 4-1/8	4	G1/8"	10 stuks		9.10
7572 4-1/4	4	G1/4"	10 stuks		9.25
7572 6-1/8	6	G1/8"	10 stuks		9.85
7572 6-1/4	6	G1/4"	10 stuks		9.95

Genoemde prijs is per stuk, afname alleen per verpakkingseenheid van 10 stuks.



Y-multiverloop - inschroef draaibaar

0158	OD A mm	OD B mm			€
7575 6-4	6	4x 4 mm	10 stuks		7.35
7575 8-6	8	4x 6 mm	10 stuks		7.90

Genoemde prijs is per stuk, afname alleen per verpakkingseenheid van 10 stuks.



Rechte koppeling

0158	OD mm				€
7580 4	4		10 stuks		2.50
7580 6	6		10 stuks		2.50
7580 8	8		10 stuks		2.85
7580 10	10		10 stuks		3.50
7580 12	12		10 stuks		4.35

Genoemde prijs is per stuk, afname alleen per verpakkingseenheid van 10 stuks.



Banjo enkel

0158	OD mm				€
7610 4-1/8	4	G1/8"	10 stuks		1.75
7610 6-1/8	6	G1/8"	10 stuks		1.75
7610 6-1/4	6	G1/4"	10 stuks		1.90
7610 8-1/8	8	G1/8"	10 stuks		2.25
7610 8-1/4	8	G1/4"	10 stuks		2.40
7610 10-1/4	10	G1/4"	10 stuks		2.95

Genoemde prijs is per stuk, afname alleen per verpakkingseenheid van 10 stuks.



Banjo enkel+bout - inschroef twee-voudig

0158	OD mm				€
7612 02-4-1/8	4	G1/8"	10 stuks		7.10
7612 02-6-1/8	6	G1/8"	10 stuks		7.10
7612 02-6-1/4	6	G1/4"	10 stuks		9.35
7612 02-8-1/8	8	G1/8"	10 stuks		8.20
7612 02-8-1/4	8	G1/4"	10 stuks		9.75
7612 02-10-1/4	10	G1/4"	10 stuks		10.75
7612 02-10-3/8	10	G3/8"	10 stuks		14.00
7612 02-12-3/8	12	G3/8"	10 stuks		16.15

Genoemde prijs is per stuk, afname alleen per verpakkingseenheid van 10 stuks.



Banjo enkel+bout - inschroef drie-voudig

0158	OD mm				€
7612 03-4-1/8	4	G1/8"	10 stuks		11.80
7612 03-6-1/8	6	G1/8"	10 stuks		11.80
7612 03-6-1/4	6	G1/4"	10 stuks		16.80
7612 03-8-1/8	8	G1/8"	10 stuks		13.30
7612 03-8-1/4	8	G1/4"	10 stuks		17.35
7612 03-10-1/4	10	G1/4"	10 stuks		18.95

Genoemde prijs is per stuk, afname alleen per verpakkingseenheid van 10 stuks.



Banjo enkel+bout inbus - inschroef O-ring

0158	OD mm				€
7622 4-1/8	4	G1/8"	10 stuks		4.00
7622 6-1/8	6	G1/8"	10 stuks		4.00
7622 6-1/4	6	G1/4"	10 stuks		4.50
7622 8-1/8	8	G1/8"	10 stuks		4.35
7622 8-1/4	8	G1/4"	10 stuks		4.90
7622 10-1/4	10	G1/4"	10 stuks		5.45
7622 10-3/8	10	G3/8"	10 stuks		5.95

Genoemde prijs is per stuk, afname alleen per verpakkingseenheid van 10 stuks.



Holle bout dubbel

0158	OD mm				€
7632 02-1/8	G1/8"		10 stuks		2.65
7632 02-1/4	G1/4"		10 stuks		3.70

Genoemde prijs is per stuk, afname alleen per verpakkingseenheid van 10 stuks.

KELM™
pneumatiek

Hydrauliek

Snel-
koppelingen

Afsluiters

Roestvast
staal

Fittingen

Lucht-
conditionering

Gereedschap

Pneumatiek

Diversen

Malleabele
fittingen
& staal

Ringleiding-
systemen

Slangen

Compressoren

Series 7000 - Super Rapid COMPACT - insteekkoppelingen



Holle bout triple

0158			
7632 03-1/8	G1/8"	10 stuks	5.25
7632 03-1/4	G1/4"	10 stuks	9.65

Genoemde prijs is per stuk, afname alleen per verpakkingseenheid van 10 stuks.



Banjo dubbel

0158				
7640 4-1/8	4	G1/8"	10 stuks	3.85
7640 6-1/8	6	G1/8"	10 stuks	3.85
7640 6-1/4	6	G1/4"	10 stuks	4.35
7640 8-1/8	8	G1/8"	10 stuks	5.05
7640 8-1/4	8	G1/4"	10 stuks	5.45
7640 10-1/4	10	G1/4"	10 stuks	6.65

Genoemde prijs is per stuk, afname alleen per verpakkingseenheid van 10 stuks.



Banjo dubbel+bout - inschroef twee-voudig

0158				
7642 02-4-1/8	4	G1/8"	10 stuks	11.25
7642 02-6-1/8	6	G1/8"	10 stuks	11.25
7642 02-6-1/4	6	G1/4"	10 stuks	13.65
7642 02-8-1/8	8	G1/8"	10 stuks	13.80
7642 02-8-1/4	8	G1/4"	10 stuks	15.75
7642 02-10-1/4	10	G1/4"	10 stuks	18.15

Genoemde prijs is per stuk, afname alleen per verpakkingseenheid van 10 stuks.



Banjo dubbel+bout - inschroef drie-voudig

0158				
7642 03-4-1/8	4	G1/8"	10 stuks	18.10
7642 03-6-1/8	6	G1/8"	10 stuks	18.10
7642 03-6-1/4	6	G1/4"	10 stuks	23.15
7642 03-8-1/8	8	G1/8"	10 stuks	21.70
7642 03-8-1/4	8	G1/4"	10 stuks	26.35
7642 03-10-1/4	10	G1/4"	10 stuks	30.05

Genoemde prijs is per stuk, afname alleen per verpakkingseenheid van 10 stuks.



Banjo dubbel+bout inbus - inschroef O-ring

0158				
7652 4-1/8	4	G1/8"	10 stuks	6.10
7652 6-1/8	6	G1/8"	10 stuks	6.10
7652 6-1/4	6	G1/4"	10 stuks	7.00
7652 8-1/8	8	G1/8"	10 stuks	7.00
7652 8-1/4	8	G1/4"	10 stuks	7.70
7652 10-1/4	10	G1/4"	10 stuks	9.10
7652 10-3/8	10	G3/8"	10 stuks	9.85

Genoemde prijs is per stuk, afname alleen per verpakkingseenheid van 10 stuks.



Verlooppijp

0158				
7800 4-6	4	6	10 stuks	1.85
7800 4-8	4	8	10 stuks	2.05
7800 6-8	6	8	10 stuks	2.10
7800 6-10	6	10	10 stuks	2.35
7800 6-12	6	12	10 stuks	3.10
7800 8-10	8	10	10 stuks	2.85
7800 8-12	8	12	10 stuks	3.15
7800 10-12	10	12	10 stuks	4.20
7800 10-14	10	14	10 stuks	4.05

Genoemde prijs is per stuk, afname alleen per verpakkingseenheid van 10 stuks.



Rechte pijp

0158			
7950 4	4	10 stuks	1.40
7950 6	6	10 stuks	1.55
7950 8	8	10 stuks	1.65
7950 10	10	10 stuks	1.80
7950 12	12	10 stuks	2.20

Genoemde prijs is per stuk, afname alleen per verpakkingseenheid van 10 stuks.



Professionals in Flow & Fluid Technology

Tel
Fax
Website
E-mail

+31(0) 499 49 10 90
+31(0) 499 49 63 70
www.aimfluid.nl
info@aimfluid.nl

aim fluid control b.v.
Ekkersrijt 7310
NL-5692 HH Son en Breugel
The Netherlands

