

ARTICULO: 2108 Válvula de mariposa tipo LUG. Butterfly valve LUG type.

Características

1. Válvula de mariposa tipo Lug.
2. Cuerpo de fundición Nodular GGG-40 para montaje entre bridas DIN PN 10/16.
3. Elastómero de EPDM.
4. Disco de acero Inoxidable 316 (CF8M).
5. Brida montaje actuadores según ISO 5211 – DIN 3337.
6. Longitud entre caras según UNE EN 558-1 Serie 20 (DIN 3202 K1).
7. Pintado con pintura Epoxi.
8. Máxima presión de trabajo:
16 Kg/cm² (medidas DN50 a DN150)
10 Kg/cm² (medidas DN200 a DN300)
9. Temperatura de trabajo -20°C +120 °C.

Features

1. Butterfly valve Lug type.
2. GGG-40 Ductil Iron body allows installation in DIN PN 10/16 pipe flange.
3. EPDM body seat.
4. Butterfly made in Stainless steel 316 (CF8M).
5. Actuator mounting plate according ISO 5211 – DIN 3337.
6. Face to face according UNE EN 558-1 Serie 20 (DIN 3202 K1).
7. Epoxi painted.
8. Maximum working pressure:
16 Kg/cm² (sizes DN50 to DN150)
10 Kg/cm² (sizes DN200 to DN300)
9. Working Temperature -20°C + 120 °C.

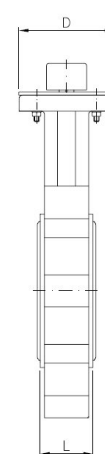
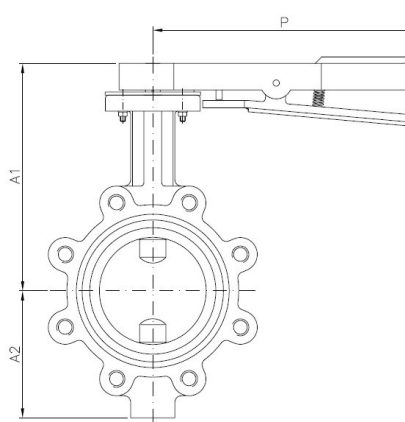
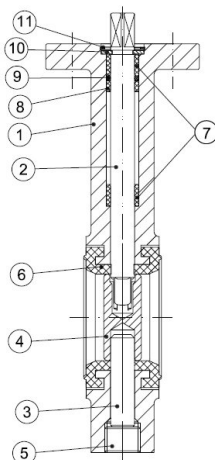

Nº	Denominación / Name	Material	Acabado Superficial/Surface Treatment
1	Cuerpo / Body	Fundición GGG-40 / Ductil iron GGG-40	Pintado Epoxi / Epoxi Painted
2	Eje / Stem	Acero Inox AISI 416 / SS 416	-----
3	Pivote / Pivot	Acero Inox AISI 416 / SS 416	-----
4	Disco / Disc	Acero Inox AISI 316 / SS 316	Granallado / Shot Blasting
5	Tapón / Cap	Acero Carbono / Carbon Steel	Cincado / Zinc PLated
6	Elastómero / Seat	EPDM	-----
7	Casquillo / Bush	PTFE + Grafito	-----
8	Casquillo / Bush	PTFE + Grafito	-----
9	Tórica / O' ring	NBR	-----
10	Arandela / Washer	Bronze	-----
11	Seguro / Stop Ring	Acero / Steel	-----

DIMENSIONES GENERALES / GENERAL DIMENSIONS

Ref	DN	L	Dimensiones/Dimensions (mm)					N-M	Peso/ Weight (kg)
			A1	A2	D	P	J		
2108 09	50	43	190	79	90	270	****	4 x M16	4,800
2108 10	65	46	190	93	90	270	****	4 x M16	5,500
2108 11	80	46	195	103	90	270	****	8 x M16	7,000
2108 12	100	52	215	120	90	270	****	8 x M16	8,100
2108 13	125	56	240	133	90	270	****	8 x M16	10,900
2108 14	150	56	240	158	125	300	****	8 x M20	14,000
2108 16	200	60	280	180	125	300	****	8 x M20	19,400
2108 18	250	68	325	216	125	300	****	12 x M20	28,500
2108 20	300	78	351	251	150	Ø290	240	12 x M20	49,600

*** Nota: A partir de 12" (DN 300) operación mediante reductor manual.

*** Note: From 12" included, handling by gear operator.

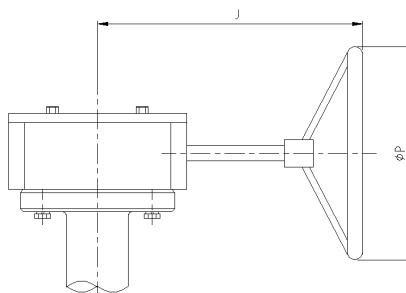

Dimensiones de brida superior / Top flange dimensions:

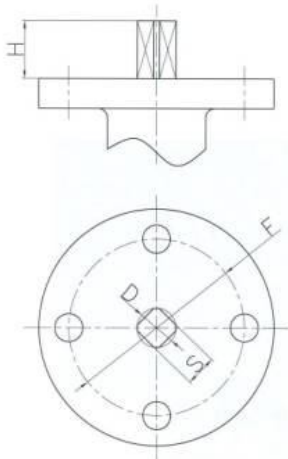

Dimensiones Brida Superior / Top Flange Dimensions						
Ref.	DN	F (ISO 5211)	S mm	D mm	H mm	Torque Nm
2108 09	50	F07	11	14	30	12
2108 10	65	F07	11	14	30	20
2108 11	80	F07	11	14	30	27
2108 12	100	F07	14	18	30	40
2108 13	125	F07	14	18	30	60
2108 14	150	F07 – F10	17	22	30	90
2108 16	200	F07 – F10	17	22	30	120
2108 18	250	F10	22	28	30	180
2108 20	300	F10 – F12	22	28	30	340

Perdidas de Carga (Cv) según posición del disco / Head losses according disc position:

DN	Posición del Disco (grados) / Disc Position (degrees)								
	90°	80°	70°	60°	50°	40°	30°	20°	10°
50	144	114	84	61	43	27	16	7	1
65	282	223	163	107	67	43	24	11	1.5
80	461	364	267	154	96	61	35	15	2
100	841	701	496	274	171	109	62	27	3
125	1376	1146	775	428	268	170	98	43	5
150	1850	1542	1025	567	354	225	129	56	6
200	3316	2842	1862	1081	680	421	241	102	12
250	5430	4525	2948	1710	1076	667	382	162	19
300	8077	6731	4393	2563	1594	1005	555	235	27

Medidas de Precaución para instalación / Precautions measures for Installation:

1. No instale la válvula en posición totalmente cerrada / *Do not assemble the butterfly valve in total closed position.*
2. Verifique el buen paralelismo de las bridas / *Check the good parallelism of the flanges.*
3. No coloque otras juntas entre las bridas / *Do not insert others gasket between flange and valve.*

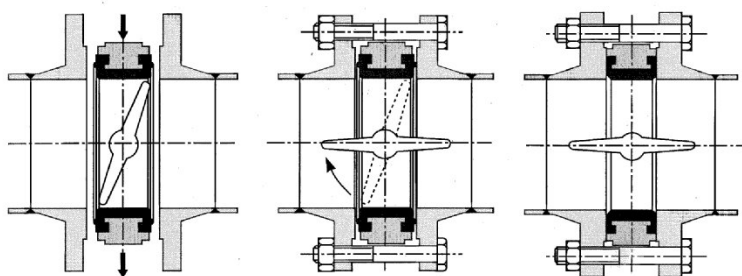

4. Si la válvula va ha ser instalada al final de la tubería las presiones máximas de trabajo son: / *If the valve goes there is to be installed at the end of the pipe the maximum working pressures are:*

DN50 a / to DN150 16 Kg/cm² x 0.4 = 6,4 Kg/cm²
 DN200 a / to DN300 10 Kg/cm² x 0.4 = 4,0 Kg/cm²

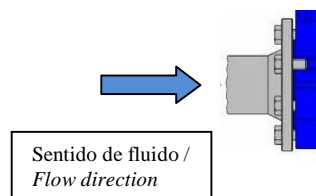

CURVA PRESION TEMPERATURA / PRESSURE TEMPERATURE RATING

