

Electrisch bediende
3-Weg
Messing vernikkelde kogelkraan
E8505A



E8505A

Robuuste, electrisch bediende 3-Weg messing vernikkelde kogelkraan voorzien van JJ J+J actuator in dubbelwerkende uitvoering met L-Boring, T1, T2 of T3-Boring

DOORLAAT

DN08 (1/4") tot DN20 (3/4")

AANSLUITING

- Binnendraad volgens UNI EN 10226 (DIN ISO 7/1)
- Opbouwflens volgens ISO 5211

BEDRIJFSDRUK

Van PN40 (1/4) tot PN25 (2")

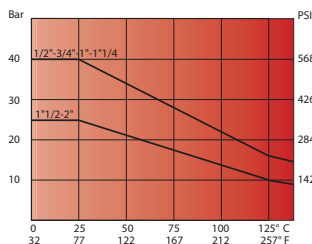

TEMPERATUUR BEREIK

Van -20° tot +130°C

MATERIALEN

Huis: Messing CW 617 N UNI EN 12165
Kogel: Messing, hardverchromd CW 614 N UNI EN 12164
Kogelafdichting: PTFE
As: Messing, hardverchromd CW 614 N UNI EN 12164
As afdichting: PTFE
O-Ring: Elastomeer
Stopbuswarterel: Messing CW

DOORSTROMINGSRICHTING

Naar keuze.

MONTAGE

Raadpleeg aanbeveling voor inbouw industriële afsluiters.

MEDIUM

Neutrale gassen en vloeistoffen. Voor toepassingen met agressieve media bestendigheidstabel raadplegen. Bepaalde media kunnen het draaimoment verhogen.

BEDIENING (Standaard)

Met elektrische actuator.

BEDRIJFSSPANNING

12 -24V AC/DC, 110-240V AC/DC

ENKELE VOORDELEN OP EEN RIJ

- ETL (Elektrisch draaimoment-begrenzing).
- AVS (Automatische spanning herkenning).
- ATC (Automatische temperatuurregeling om condensvorming te voorkomen).
- Handnoodbediening.
- 2 geïntegreerde, potentiaalvrije microschemelaars voor terugmelding

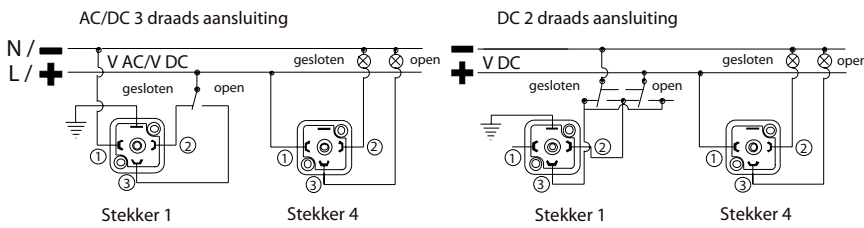
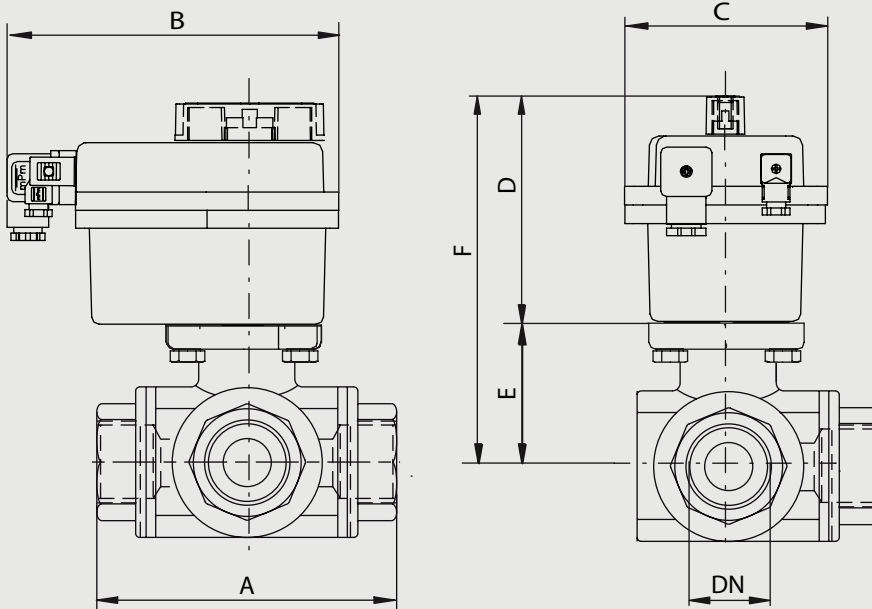

Boring en schakelstand

Boring	T	L
90°		
0°		
L	T1 = 04	T2 = 05
	T3 = 06	L4 = 03

Dubbelwerkende kogelkraan, L4-boring met gasdraad, 12-24 Volt AC/DC

Doorlaat[mm] aansluiting[mm]		max. druk [bar] PN	M(1) +30% [Nm]	Flens	4-kant	Kv	Electrische Actuator	Inbouwmaat [mm] en gewicht [kg]						Bestelcode	
DN	Rp							A	B	C	D	E	F		Gewicht
8	1/4	40	7,2	F03	9	5,9	L010	64,5	169	104	126,5	38	164,5	2,00	3E8505030514A
10	3/8	40	7,2	F03	9	9,4	L010	64,5	169	104	126,5	38	164,5	1,95	3E8505031014A
15	1/2	40	7,2	F03	9	17	L010	64,5	169	104	126,5	38	164,5	1,90	3E8505031514A
20	3/4	40	8,5	F03	9	41	L010	76	169	104	126,5	42	168,5	2,20	3E8505032014A

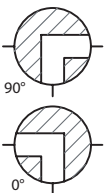

Dubbelwerkende kogelkraan, L4-boring met gasdraad, 110-240 Volt AC/DC

Doorlaat[mm] aansluiting[mm]		max. druk [bar] PN	M(1) +30% [Nm]	Flens	4-kant	Kv	Electrische Actuator	Inbouwmaat [mm] en gewicht [kg]						Bestelcode	
DN	Rp							A	B	C	D	E	F		Gewicht
8	1/4	40	7,2	F03	9	5,9	H010	64,5	169	104	126,5	38	164,5	2,00	3E8505030544A
10	3/8	40	7,2	F03	9	9,4	H010	64,5	169	104	126,5	38	164,5	1,95	3E8505031044A
15	1/2	40	7,2	F03	9	17	H010	64,5	169	104	126,5	38	164,5	1,90	3E8505031544A
20	3/4	40	8,5	F03	9	41	H010	76	169	104	126,5	42	168,5	2,20	3E8505032044A

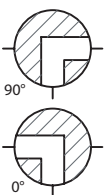

E8505A

Dubbelwerkende kogelkraan, T1-boring met gasdraad, 12-24 Volt AC/DC

Doorlaat[mm] aansluiting[mm]		max. druk [bar] PN	M(1) +30% [Nm]	Flens	4-kant	Kv	Electrische Actuator	Inbouwmaat [mm] en gewicht [kg]						Bestelcode	
DN	Rp							A	B	C	D	E	F		Gewicht
8	1/4	40	7,2	F03	9	5,9	L010	64,5	169	104	126,5	38	164,5	2,00	3E8505040514A
10	3/8	40	7,2	F03	9	9,4	L010	64,5	169	104	126,5	38	164,5	1,95	3E8505041014A
15	1/2	40	7,2	F03	9	17	L010	64,5	169	104	126,5	38	164,5	1,90	3E8505041514A
20	3/4	40	8,5	F03	9	41	L010	76	169	104	126,5	42	168,5	2,20	3E8505042014A

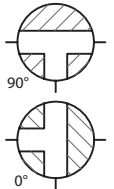

Dubbelwerkende kogelkraan, T1-boring met gasdraad, 110-240 Volt AC/DC

Doorlaat[mm] aansluiting[mm]		max. druk [bar] PN	M(1) +30% [Nm]	Flens	4-kant	Kv	Electrische Actuator	Inbouwmaat [mm] en gewicht [kg]						Bestelcode	
DN	Rp							A	B	C	D	E	F		Gewicht
8	1/4	40	7,2	F03	9	5,9	H010	64,5	169	104	126,5	38	164,5	2,00	3E8505040544A
10	3/8	40	7,2	F03	9	9,4	H010	64,5	169	104	126,5	38	164,5	1,95	3E8505041044A
15	1/2	40	7,2	F03	9	17	H010	64,5	169	104	126,5	38	164,5	1,90	3E8505041544A
20	3/4	40	8,5	F03	9	41	H010	76	169	104	126,5	42	168,5	2,20	3E8505042044A

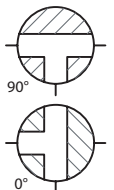

Dubbelwerkende kogelkraan, T2-boring met gasdraad, 12-24 Volt AC/DC

Doorlaat[mm] aansluiting[mm]		max. druk [bar] PN	M(1) +30% [Nm]	Flens	4-kant	Kv	Electrische Actuator	Inbouwmaat [mm] en gewicht [kg]						Bestelcode	
DN	Rp							A	B	C	D	E	F		Gewicht
8	1/4	40	7,2	F03	9	5,9	L010	64,5	169	104	126,5	38	164,5	2,00	3E8505050514A
10	3/8	40	7,2	F03	9	9,4	L010	64,5	169	104	126,5	38	164,5	1,95	3E8505051014A
15	1/2	40	7,2	F03	9	17	L010	64,5	169	104	126,5	38	164,5	1,90	3E8505051514A
20	3/4	40	8,5	F03	9	41	L010	76	169	104	126,5	42	168,5	2,20	3E8505052014A

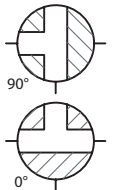

Dubbelwerkende kogelkraan, T2-boring met gasdraad, 110-240 Volt AC/DC

Doorlaat[mm] aansluiting[mm]		max. druk [bar] PN	M(1) +30% [Nm]	Flens	4-kant	Kv	Electrische Actuator	Inbouwmaat [mm] en gewicht [kg]						Bestelcode	
DN	Rp							A	B	C	D	E	F		Gewicht
8	1/4	40	7,2	F03	9	5,9	H010	64,5	169	104	126,5	38	164,5	2,00	3E8505050544A
10	3/8	40	7,2	F03	9	9,4	H010	64,5	169	104	126,5	38	164,5	1,95	3E8505051044A
15	1/2	40	7,2	F03	9	17	H010	64,5	169	104	126,5	38	164,5	1,90	3E8505051544A
20	3/4	40	8,5	F03	9	41	H010	76	169	104	126,5	42	168,5	2,20	3E8505052044A

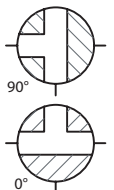

Dubbelwerkende kogelkraan, T3-boring met gasdraad, 12-24 Volt AC/DC

Doorlaat[mm] aansluiting[mm]		max. druk [bar] PN	M(1) +30% [Nm]	Flens	4-kant	Kv	Electrische Actuator	Inbouwmaat [mm] en gewicht [kg]						Bestelcode	
DN	Rp							A	B	C	D	E	F		Gewicht
8	1/4	40	7,2	F03	9	5,9	L010	64,5	169	104	126,5	38	164,5	2,00	3E8505060514A
10	3/8	40	7,2	F03	9	9,4	L010	64,5	169	104	126,5	38	164,5	1,95	3E8505061014A
15	1/2	40	7,2	F03	9	17	L010	64,5	169	104	126,5	38	164,5	1,90	3E8505061514A
20	3/4	40	8,5	F03	9	41	L010	76	169	104	126,5	42	168,5	2,20	3E8505062014A

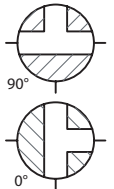

**Electrisch bediende
3-Weg
Messing vernikkelde kogelkraan**

E8505A

Dubbelwerkende kogelkraan, T3-boring met gasdraad, 110-240 Volt AC/DC

Doorlaat[mm] aansluiting[mm]		max. druk [bar] PN	M(1) +30% [Nm]	Flens	4-kant	Kv	Electrische Actuator	Inbouwmaat [mm] en gewicht [kg]							Bestelcode
DN	Rp							A	B	C	D	E	F	Gewicht	
8	1/4	40	7,2	F03	9	5,9	H010	64,5	169	104	126,5	38	164,5	2,00	3E8505060544A
10	3/8	40	7,2	F03	9	9,4	H010	64,5	169	104	126,5	38	164,5	1,95	3E8505061044A
15	1/2	40	7,2	F03	9	17	H010	64,5	169	104	126,5	38	164,5	1,90	3E8505061544A
20	3/4	40	8,5	F03	9	41	H010	76	169	104	126,5	42	168,5	2,20	3E8505062044A

