

Electrically operated
Direct-acting 2-way
Stainless Steel solenoid valve
BURKERT 0330



Burkert 0330

Burkert 0330, Electrically operated direct-acting 2/2-way stainless steel solenoid valve.

SIZE

DN2,0 to DN4,0 (1/4")

CONNECTION

- 2-Sided female thread according to ISO 228
- 3-Sided female thread according to ISO 228

NOMINAL PRESSURE

Maximum 16bar

TEMPERATURE FLUID

From:

0° to +80°C (NBR)

0° to +90°C (FPM)

-30° to +90°C (EPDM)

MATERIALS

Seal: NBR, FPM or EPDM

Internal parts: Stainless steel

FLOW DIRECTION

A: 2/2 way direct-acting solenoid valve, normally closed

B: 2/2 way direct-acting solenoid valve, normally open

MOUNTING POSITION

Solenoid valve can be mounted in any position, preferably mounting with the coil pointing vertically upwards.

MEDIUM

Neutral gases and liquids. For applications with aggressive media consult resistance table.

SOME ADVANTAGES

Direct acting, total isolation solenoid valve: the actuator is totally isolated from the fluid so that the wetted parts are just the body and the diaphragm.

VOLTAGE TOLERANCE

+ 10% / -10%

DUTY CYCLE

100% ED

AMBIENT TEMPERATURE

max. + 55 ° C

ELECTRICAL CONNECTION

Plug DIN 43650 for DIN A plugs

ELECTRIC PROTECTION

With plug Type 2508 / HST30 IP65

TECHNICAL SPECIFICATIONS

- Maximum allowable pressure: 16 bar
- Opening time: DN2-4mm 15ms
- Closing time: DN2-40ms 8ms
- Maximum viscosity: 5 ° E (~37 cStokes or mm²/ s)

**Electrically operated
Direct-acting 2-way
Stainless Steel solenoid valve
BURKERT 0330**

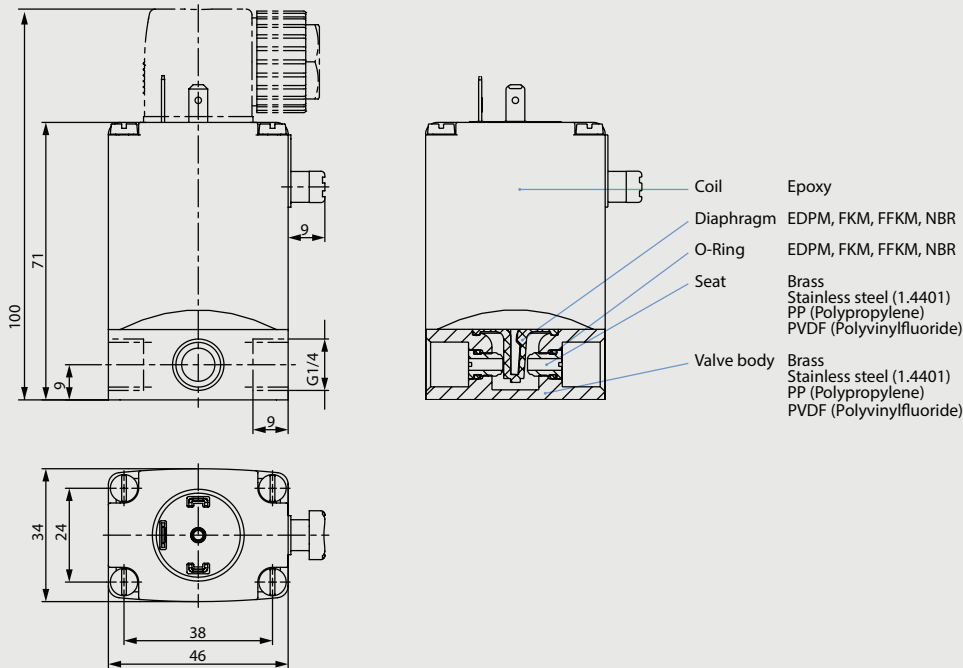

2/2 NC, FPM, 024V/DC

Burkert 0330 A 3/2 way direct acting solenoid valve electrically operated NC (normally closed) 24 volt DC

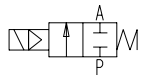

Nominal[mm] connection[mm]		Press. (min)	Press. (max) Gas	Press. (max) Liquid	Kv [m3/h]	Coil	Consump- tion	Dimension [mm] and weight [kg]				Order Code
DN	Rp							Length	Width	Height	Weight	
2,0	G1/4	0	16	16	0,08		8W	46	34	100	0,470	00017650
3,0	G1/4	0	10	10	0,14		8W	46	34	100	0,470	00020292
4,0	G1/4	0	5	5	0,29		8W	46	34	100	0,470	00018276

2/2 NC, FPM, 024V/50Hz

Burkert 0330 A 3/2 way direct acting solenoid valve electrically operated NC (normally closed) 24 volt AC

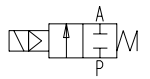

Nominal[mm] connection[mm]		Press. (min)	Press. (max) Gas	Press. (max) Liquid	Kv [m3/h]	Coil	Consump- tion	Dimension [mm] and weight [kg]				Order Code
DN	Rp							Length	Width	Height	Weight	
3,0	G1/4	0	10	10	0,18		20-11VA	46	34	100	0,470	00023984
4,0	G1/4	0	5	5	0,23		20-11VA	46	34	100	0,470	00018857

2/2 NC, FPM, 110V/50Hz

Burkert 0330 A 3/2 way direct acting solenoid valve electrically operated NC (normally closed) 110 volt AC

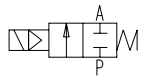

Nominal[mm] connection[mm]		Press. (min)	Press. (max) Gas	Press. (max) Liquid	Kv [m3/h]	Coil	Consump- tion	Dimension [mm] and weight [kg]				Order Code
DN	Rp							Length	Width	Height	Weight	
2,0	G1/4	0	16	16	0,11		20-11VA	46	34	100	0,470	00136521
4,0	G1/4	0	5	5	0,23		20-11VA	46	34	100	0,470	00023830

**Electrically operated
Direct-acting 2-way
Stainless Steel solenoid valve**

BURKERT 0330

2/2 NC, FPM, 230V/50Hz

Burkert 0330 A 3/2 way direct acting solenoid valve electrically operated NC (normally closed) 230 volt AC

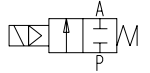

Nominal[mm] connection[mm]		Press. (min)	Press. (max) Gas	Press. (max) Liquid	Kv [m3/h]	Coil	Consumption	Dimension [mm] and weight [kg]				Order Code
DN	Rp							Length	Width	Height	Weight	
2,0	G1/4	0	16	16	0,11		20-11VA	46	34	100	0,470	00078117
3,0	G1/4	0	10	10	0,18		20-11VA	46	34	100	0,470	00024563
4,0	G1/4	0	5	5	0,23		20-11VA	46	34	100	0,470	00020873

2/2 NO, FPM, 024V/DC

Burkert 0330 B 3/2 way direct acting solenoid valve electrically operated NO (normally open) 24 volt DC

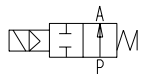

Nominal[mm] connection[mm]		Press. (min)	Press. (max) Gas	Press. (max) Liquid	Kv [m3/h]	Coil	Consumption	Dimension [mm] and weight [kg]				Order Code
DN	Rp							Length	Width	Height	Weight	
3,0	G1/4	0	10	10	0,14		8W	46	34	100	0,470	00141928
4,0	G1/4	0	5	5	0,29		8W	46	34	100	0,470	00141932

2/2 NO, FPM, 024V/50Hz

Burkert 0330 B 3/2 way direct acting solenoid valve electrically operated NO (normally open) 24 volt AC

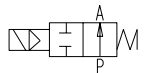

Nominal[mm] connection[mm]		Press. (min)	Press. (max) Gas	Press. (max) Liquid	Kv [m3/h]	Coil	Consumption	Dimension [mm] and weight [kg]				Order Code
DN	Rp							Length	Width	Height	Weight	
3,0	G1/4	0	10	10	0,18		20-11VA	46	34	100	0,470	00141929
4,0	G1/4	0	5	5	0,23		20-11VA	46	34	100	0,470	00141933

2/2 NO, FPM, 230V/50Hz

Burkert 0330 B 3/2 way direct acting solenoid valve electrically operated NO (normally open) 230 volt AC

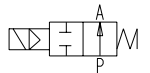

Nominal[mm] connection[mm]		Press. (min)	Press. (max) Gas	Press. (max) Liquid	Kv [m3/h]	Coil	Consumption	Dimension [mm] and weight [kg]				Order Code
DN	Rp							Length	Width	Height	Weight	
2,0	G1/4	0	16	16	0,11		20-11VA	46	34	100	0,470	00041137
3,0	G1/4	0	10	10	0,18		20-11VA	46	34	100	0,470	00141931
4,0	G1/4	0	5	5	0,23		20-11VA	46	34	100	0,470	00141935



**Electrically operated
Direct-acting 2-way
Stainless Steel solenoid valve**

BURKERT 0330