

Handbediende
3-Weg
RVS kogelkraan
H8026 APE



H8026 APE

Robuuste, handbediende 3-Weg RVS kogelkraan voorzien van ISO-Top t.b.v opbouw actuator met L of T boring

DOORLAAT

DN08 (1/4") tot DN100 (4")

AANSLUITING

- Binnendraad volgens DIN 2999, DIN 259
- Opbouwflens volgens ISO 5211

BEDRIJFSDRUK

Max PN63

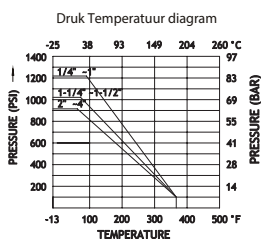

TEMPERATUUR BEREIK

Van -25° tot +180°C

MATERIALEN

Huis: RVS CF8M DIN 1.4408
Kogel: RVS AISI 316
Kogelafdichting: R-PTFE 15% glasvezelversterkt
As: RVS AISI 316
As afdichting: PTFE
O-Ring: FPM
Stopbusafdichting: PTFE
Hendel: RVS AISI 304

DOORSTROMINGSRICHTING

Naar keuze.

MONTAGE

Raadpleeg aanbeveling voor inbouw industriële afsluiters.

MEDIUM

Neutrale gassen en vloeistoffen. Voor toepassingen met agressieve media bestendigheidstabel raadplegen. Bepaalde media kunnen het draaimoment verhogen.

BEDIENING (Standaard)

Hendel (te beveiligen met slot) of vrije as.







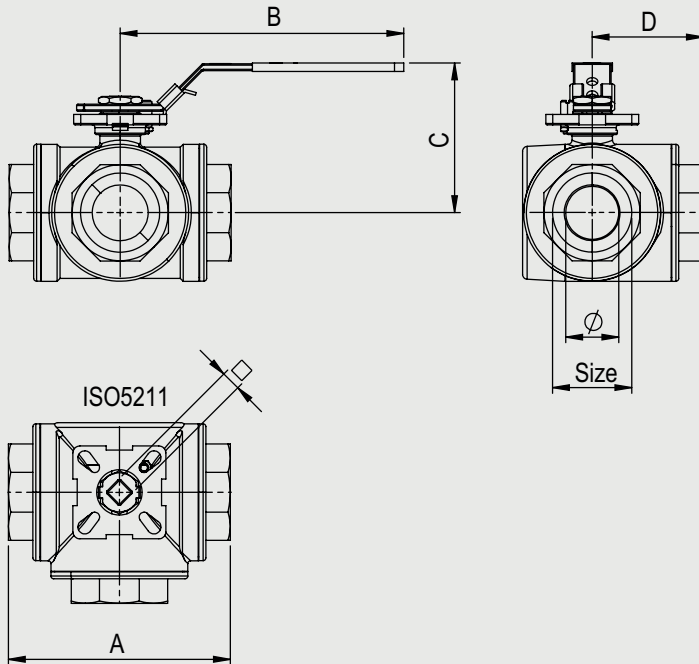

BIJZONDERHEDEN

As: Blow-out proof
Anti statische constructie
ATEX-versie op aanvraag

Handbediende
3-Weg
RVS kogelkraan
H8026 APE



Boring en schakelbeeld dubbelwerkend

Boring	T			L
90°				
0°				
L	T1 = 04	T2 = 05	T3 = 06	L4 = 03

H8026 APE

Kogelkraan 3-weg L-boring met gasdraad, ISO Top en hendel

Doorlaat[mm] aansluiting[mm]		max. druk [bar] PN	M(1) +30% [Nm]	Flens	4-kant	Kv [m ³ /h]	Inbouwmaat [mm] en gewicht [kg]					Bestelcode	
DN	Rp						∅	A	B	C	D		Gewicht
8	G1/4	63	8	F03/F04	9		9,5	75	130	66	37,5	0,700	3H8026400305
10	G3/8	63	8	F03/F04	9		11	75	130	66	37,5	0,700	3H8026400310
15	G1/2	63	8	F03/F04	9		12	75	130	66	37,5	0,700	3H8026400315
20	G3/4	63	9	F04/F05	11		15	85	161	72	42,5	0,940	3H8026400320
25	G1	63	15	F04/F05	11		20	100	161	77	50	1,390	3H8026400325
32	G1.1/4	63	20	F05/F07	14		25	122	203	92	61	2,910	3H8026400330
40	G1.1/4	63	30	F05/F07	14		32	131	203	96	65,5	3,660	3H8026400335
50	G2	63	45	F05/F07	14		40	158	203	107	79	6,310	3H8026400340
65	G2.1/2	63	70	F07/F10	17		49	178	254	135	89	8,950	3H8026400345
80	G3	63	100	F07/F10	17		60	202	254	147	101	13,110	3H8026400350
100	G4	63	150	F07/F10	17		75	246	310	160	123	22,100	3H8026400355

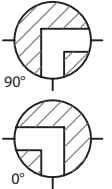

Kogelkraan 3-weg T-boring met gasdraad, ISO Top en hendel

Doorlaat[mm] aansluiting[mm]		max. druk [bar] PN	M(1) +30% [Nm]	Flens	4-kant	Kv [m ³ /h]	Inbouwmaat [mm] en gewicht [kg]					Bestelcode	
DN	Rp						∅	A	B	C	D		Gewicht
8	G1/4	63	8	F03/F04	9		9,5	75	130	66	37,5	0,700	3H8026400405
10	G3/8	63	8	F03/F04	9		11	75	130	66	37,5	0,700	3H8026400410
15	G1/2	63	8	F03/F04	9		12	75	130	66	37,5	0,700	3H8026400415
20	G3/4	63	9	F04/F05	11		15	85	161	72	42,5	0,940	3H8026400420
25	G1	63	15	F04/F05	11		20	100	161	77	50	1,380	3H8026400425
32	G1.1/4	63	20	F05/F07	14		25	122	203	92	61	2,890	3H8026400430
40	G1.1/4	63	30	F05/F07	14		32	131	203	96	65,5	3,600	3H8026400435
50	G2	63	45	F05/F07	14		40	158	203	107	79	6,210	3H8026400440
65	G2.1/2	63	70	F07/F10	17		49	178	254	135	89	8,720	3H8026400445
80	G3	63	100	F07/F10	17		60	202	254	147	101	12,810	3H8026400450
100	G4	63	150	F07/F10	17		75	246	310	160	123	21,600	3H8026400455

