

**Electrically operated
3-Way
Stainless Steel ball valve**

E8525



E8525

Solid, electrically operated 3-Way Stainless Steel ball valve with L-Bore, T1, T2 or T3-Bore and JJ J+J J4C double acting brushless actuator

SIZE

DN08 (1/4") to DN50 (2.1/2")

CONNECTION

- 2-Sided female thread according to DIN 2999, DIN 259
- Mounting flange according to ISO 5211

NOMINAL PRESSURE

Maximum PN63

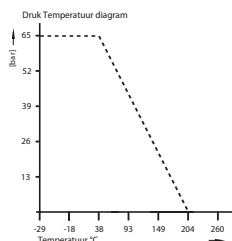

TEMPERATURE RANGE

From -25° to +180°C

MATERIALS

Body: stainless steel DIN 1.4408 (CF8M)
Ball: stainless steel AISI 316
Ball seal: PTFE 15% glass fiber reinforced
Shaft: Stainless steel AISI 316
Shaft sealing: PTFE 15% glass fiber reinforced
O-ring: FPM
Packed gland PTFE

FLOW DIRECTION

Random

MOUNTING POSITION

See mounting reference for industrial valves.

MEDIUM

Neutral gases and liquids. For applications with aggressive media consult resistance table. Certain media may increase the torque.

OPERATION (Standard)

With electric actuator.

VOLTAGE

12V AC/DC, 24-240V AC/DC

SOME ADVANTAGES

- IP 67
- Brushless Motor.
- ETL (Electrical torque limiter).
- AVS (Automatic voltage recognition).
- ATC (Automatic temperature control to avoid condensation).
- MO (Manual emergency override).
- VFC (2 integrated potential free microswitches for feedback).
- VCO (A continues lighting 2 color LED indicates normal operation of the actuator).
- PES (Protected electrical supply, the J3 accepts the same wiring connection for either AC or DC operation)

OPTIONS AND ACCESSORIES

Security power unit BSR, potentiometer for feedback, Positioner DPS, 0-10volt of 4-20mA

Electrically operated
3-Way
Stainless Steel ball valve
E8525

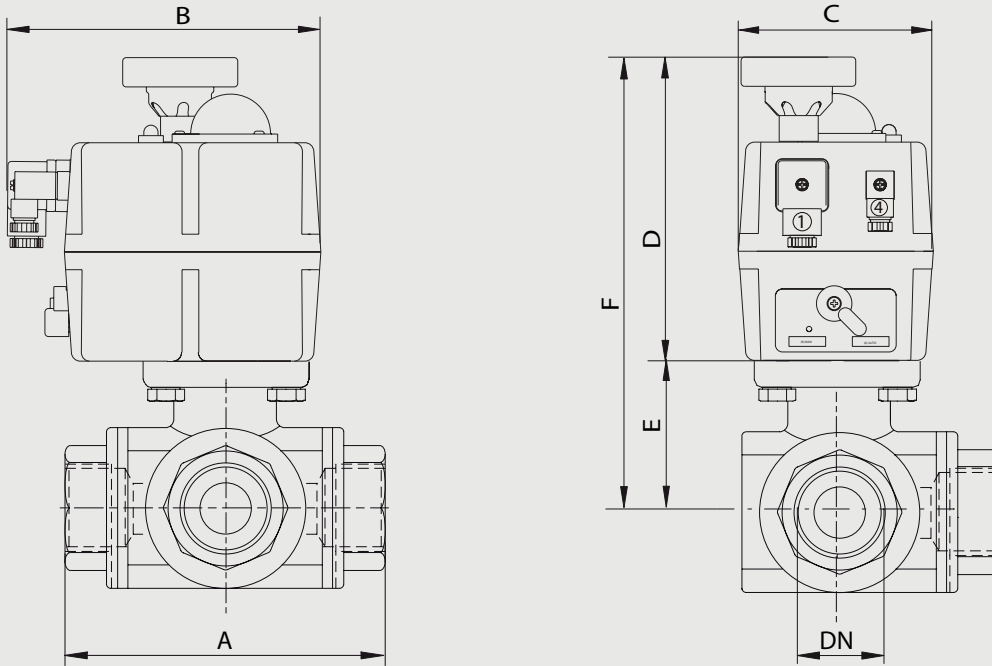

AC/DC 3 draads aansluiting

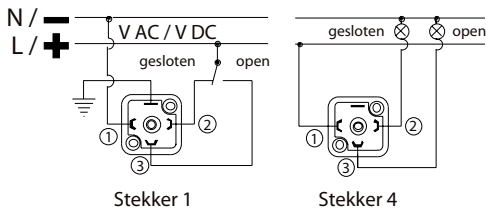

DC 2 draads aansluiting

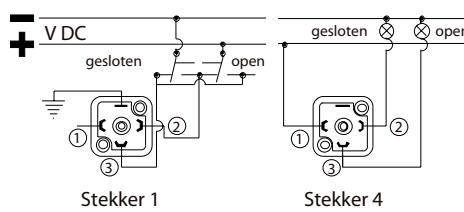

Boring en schakelstand

Boring	T			
90°				
0°				
L	T1 = 04	T2 = 05	T3 = 06	L4 = 03

**Electrically operated
3-Way
Stainless Steel ball valve**

E8525

Double-acting ball valve, L4-bore with pipe threads, 12 Volt AC/DC

Nominal[mm] connection[mm]		max. press. [bar] PN	M(1) +30% [Nm]	Flange	Square	Kv [m3/h]	Electrical Actuator	Dimension [mm] and weight [kg]							Order Code
DN	Rp							A	B	C	D	E	F	Weight	
11	G1/4	63	7	F03	9	11	B020	79	177	110	149	42	191	2,25	3E8525030512
11	G3/8	63	7	F03	9	11	B020	79	177	110	149	42	191	2,23	3E8525031012
11	G1/2	63	7	F04	9	13	B020	79	177	110	149	42	191	2,20	3E8525031512
15	G3/4	63	12	F04/F05	9	15	B020	88	177	110	149	49	198	2,50	3E8525032012
20	G1	63	16	F04/F05	11	31	B020	107	177	110	149	59	208	3,20	3E8525032512
25	G1.1/4	63	20	F05/F07	14	39	B020	125	177	110	149	65	214	4,40	3E8525033012
32	G1.1/2	63	30	F05/F07	14	62	B035	135	177	110	171	73	244	5,58	3E8525033512
40	G2	63	43	F05/F07	14	103	B055	164	177	110	196	83	279	9,30	3E8525034012

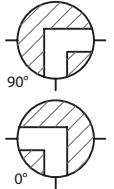

Double-acting ball valve, L4-bore with pipe threads, 24-240 Volt AC/DC

Nominal[mm] connection[mm]		max. press. [bar] PN	M(1) +30% [Nm]	Flange	Square	Kv [m3/h]	Electrical Actuator	Dimension [mm] and weight [kg]							Order Code
DN	Rp							A	B	C	D	E	F	Weight	
11	G1/4	63	7	F03	9	11	S020	79	177	110	149	42	191	2,25	3E8525030544
11	G3/8	63	7	F03	9	11	S020	79	177	110	149	42	191	2,23	3E8525031044
11	G1/2	63	7	F04	9	13	S020	79	177	110	149	42	191	2,20	3E8525031544
15	G3/4	63	12	F04/F05	9	15	S020	88	177	110	149	49	198	2,50	3E8525032044
20	G1	63	16	F04/F05	11	31	S020	107	177	110	149	59	208	3,20	3E8525032544
25	G1.1/4	63	20	F05/F07	14	39	S020	125	177	110	149	65	214	4,40	3E8525033044
32	G1.1/2	63	30	F05/F07	14	62	S035	135	177	110	171	73	244	5,58	3E8525033544
40	G2	63	43	F05/F07	14	103	S055	164	177	110	196	83	279	9,30	3E8525034044

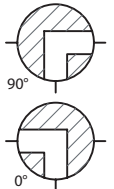

**Electrically operated
3-Way
Stainless Steel ball valve**

E8525

Double-acting ball valve, T1-bore with pipe threads, 12 Volt AC/DC

Nominal[mm] connection[mm]		max. press. [bar] PN	M(1) +30% [Nm]	Flange	Square	Kv [m3/h]	Electrical Actuator	Dimension [mm] and weight [kg]							Order Code
DN	Rp							A	B	C	D	E	F	Weight	
11	G1/4	63	7	F03	9	11	B020	79	177	110	149	42	191	2,25	3E8525040512
11	G3/8	63	7	F03	9	11	B020	79	177	110	149	42	191	2,23	3E8525041012
11	G1/2	63	7	F04	9	13	B020	79	177	110	149	42	191	2,20	3E8525041512
15	G3/4	63	12	F04/F05	9	15	B020	88	177	110	149	49	198	2,50	3E8525042012
20	G1	63	16	F04/F05	11	31	B020	107	177	110	149	59	208	3,20	3E8525042512
25	G1.1/4	63	20	F05/F07	14	39	B020	125	177	110	149	65	214	4,40	3E8525043012
32	G1.1/2	63	30	F05/F07	14	62	B035	135	177	110	171	73	244	5,58	3E8525043512
40	G2	63	43	F05/F07	14	103	B055	164	177	110	196	83	279	9,30	3E8525044012

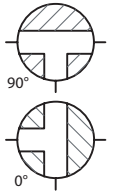

Double-acting ball valve, T1-bore with pipe threads, 24-240 Volt AC/DC

Nominal[mm] connection[mm]		max. press. [bar] PN	M(1) +30% [Nm]	Flange	Square	Kv [m3/h]	Electrical Actuator	Dimension [mm] and weight [kg]							Order Code
DN	Rp							A	B	C	D	E	F	Weight	
11	G1/4	63	7	F03	9	11	S020	79	177	110	149	42	191	2,25	3E8525040544
11	G3/8	63	7	F03	9	11	S020	79	177	110	149	42	191	2,23	3E8525041044
11	G1/2	63	7	F04	9	13	S020	79	177	110	149	42	191	2,20	3E8525041544
15	G3/4	63	12	F04/F05	9	15	S020	88	177	110	149	49	198	2,50	3E8525042044
20	G1	63	16	F04/F05	11	31	S020	107	177	110	149	59	208	3,20	3E8525042544
25	G1.1/4	63	20	F05/F07	14	39	S020	125	177	110	149	65	214	4,40	3E8525043044
32	G1.1/2	63	30	F05/F07	14	62	S035	135	177	110	171	73	244	5,58	3E8525043544
40	G2	63	43	F05/F07	14	103	S055	164	177	110	196	83	279	9,30	3E8525044044

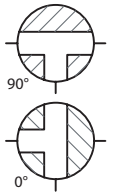

**Electrically operated
3-Way
Stainless Steel ball valve**

E8525

Double-acting ball valve, T2-bore with pipe threads, 12 Volt AC/DC

Nominal[mm] connection[mm]		max. press. [bar] PN	M(1) +30% [Nm]	Flange	Square	Kv [m3/h]	Electrical Actuator	Dimension [mm] and weight [kg]							Order Code
DN	Rp							A	B	C	D	E	F	Weight	
11	G1/4	63	7	F03	9	11	B020	79	177	110	149	42	191	2,25	3E8525050512
11	G3/8	63	7	F03	9	11	B020	79	177	110	149	42	191	2,23	3E8525051012
11	G1/2	63	7	F04	9	13	B020	79	177	110	149	42	191	2,20	3E8525051512
15	G3/4	63	12	F04/F05	9	15	B020	88	177	110	149	49	198	2,50	3E8525052012
20	G1	63	16	F04/F05	11	31	B020	107	177	110	149	59	208	3,20	3E8525052512
25	G1.1/4	63	20	F05/F07	14	39	B020	125	177	110	149	65	214	4,40	3E8525053012
32	G1.1/2	63	30	F05/F07	14	62	B035	135	177	110	171	73	244	5,58	3E8525053512
40	G2	63	43	F05/F07	14	103	B055	164	177	110	196	83	279	9,30	3E8525054012

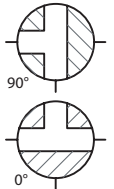

Double-acting ball valve, T2-bore with pipe threads, 24-240 Volt AC/DC

Nominal[mm] connection[mm]		max. press. [bar] PN	M(1) +30% [Nm]	Flange	Square	Kv [m3/h]	Electrical Actuator	Dimension [mm] and weight [kg]							Order Code
DN	Rp							A	B	C	D	E	F	Weight	
11	G1/4	63	7	F03	9	11	S020	79	177	110	149	42	191	2,25	3E8525050544
11	G3/8	63	7	F03	9	11	S020	79	177	110	149	42	191	2,23	3E8525051044
11	G1/2	63	7	F04	9	13	S020	79	177	110	149	42	191	2,20	3E8525051544
15	G3/4	63	12	F04/F05	9	15	S020	88	177	110	149	49	198	2,50	3E8525052044
20	G1	63	16	F04/F05	11	31	S020	107	177	110	149	59	208	3,20	3E8525052544
25	G1.1/4	63	20	F05/F07	14	39	S020	125	177	110	149	65	214	4,40	3E8525053044
32	G1.1/2	63	30	F05/F07	14	62	S035	135	177	110	171	73	244	5,58	3E8525053544
40	G2	63	43	F05/F07	14	103	S055	164	177	110	196	83	279	9,30	3E8525054044

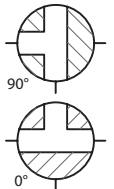

Electrically operated
3-Way
Stainless Steel ball valve

E8525

Double-acting ball valve, T3-bore with pipe threads, 12 Volt AC/DC

Nominal[mm] connection[mm]		max. press. [bar]	M(1) +30% [Nm]	Flange	Square	Kv [m3/h]	Electrical Actuator	Dimension [mm] and weight [kg]							Order Code
DN	Rp	PN						A	B	C	D	E	F	Weight	
11	G1/4	63	7	F03	9	11	B020	79	177	110	149	42	191	2,25	3E8525060512
11	G3/8	63	7	F03	9	11	B020	79	177	110	149	42	191	2,23	3E8525061012
11	G1/2	63	7	F04	9	13	B020	79	177	110	149	42	191	2,20	3E8525061512
15	G3/4	63	12	F04/F05	9	15	B020	88	177	110	149	49	198	2,50	3E8525062012
20	G1	63	16	F04/F05	11	31	B020	107	177	110	149	59	208	3,20	3E8525062512
25	G1.1/4	63	20	F05/F07	14	39	B020	125	177	110	149	65	214	4,40	3E8525063012
32	G1.1/2	63	30	F05/F07	14	62	B035	135	177	110	171	73	244	5,58	3E8525063512
40	G2	63	43	F05/F07	14	103	B055	164	177	110	196	83	279	9,30	3E8525064012

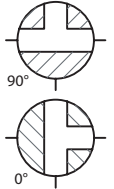

Dubbelwerkende kogelkraan, T3-boring met gasdraad, 24-240 Volt AC/DC

Nominal[mm] connection[mm]		max. press. [bar]	M(1) +30% [Nm]	Flange	Square	Kv [m3/h]	Electrical Actuator	Dimension [mm] and weight [kg]							Order Code
DN	Rp	PN						A	B	C	D	E	F	Weight	
11	G1/4	63	7	F03	9	11	S020	79	177	110	149	42	191	2,25	3E8525060544
11	G3/8	63	7	F03	9	11	S020	79	177	110	149	42	191	2,23	3E8525061044
11	G1/2	63	7	F04	9	13	S020	79	177	110	149	42	191	2,20	3E8525061544
15	G3/4	63	12	F04/F05	9	15	S020	88	177	110	149	49	198	2,50	3E8525062044
20	G1	63	16	F04/F05	11	31	S020	107	177	110	149	59	208	3,20	3E8525062544
25	G1.1/4	63	20	F05/F07	14	39	S020	125	177	110	149	65	214	4,40	3E8525063044
32	G1.1/2	63	30	F05/F07	14	62	S035	135	177	110	171	73	244	5,58	3E8525063544
40	G2	63	43	F05/F07	14	103	S055	164	177	110	196	83	279	9,30	3E8525064044

