

**Pneumatically operated
3-Way
Brass Nickel Plated ball valve
P8305**



P8305

Solid, pneumatically operated 3-Way nickel-plated brass ball valve with L- or T- Bore and GT actuator in double acting and single acting version.

SIZE

DN08 (1/4") to DN50 (2") Full bore

CONNECTION

- 2-Sided female thread according to UNI EN 10226 (DIN ISO 7/1)
- Mounting flange according to ISO 5211

NOMINAL PRESSURE

From PN40 (1/4) to PN25 (2")

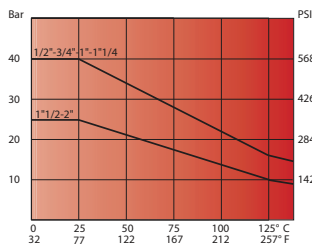

TEMPERATURE RANGE

From -20° to +150°C

MATERIALS

Body: Brass CW 617 N UNI EN 12165
 Ball: Brass, hard chrome CW 614 N UNI EN 12164
 Ball seal: PTFE
 Shaft: Brass, hard chrome CW 614 N UNI EN 12164
 Shaft sealing: PTFE
 O-Ring: Elastomer
 Stuffing box gland: brass UNI EN 12164 CW 614 N
 Packed gland PTFE

FLOW DIRECTION

Random

MOUNTING POSITION

See mounting reference for industrial valves.

MEDIUM

Neutral gases and liquids. For applications with aggressive media consult resistance table. Certain media may increase the torque.

OPERATION (Standard)

With pneumatic actuator double acting or single acting version.

CONTROL MEDIUM

Compressed air or inert gases according PNEUROP/ISO class 4, other control medium on request.

CONTROL PRESSURE

- 5,5 bar, other control pressure on request.

OPTIONS AND ACCESSORIES

Mechanical or inductive limit switches mounted in a switch box or single mounted on the actuator.

Pneumatically operated
3-Way
Brass Nickel Plated ball valve
P8305

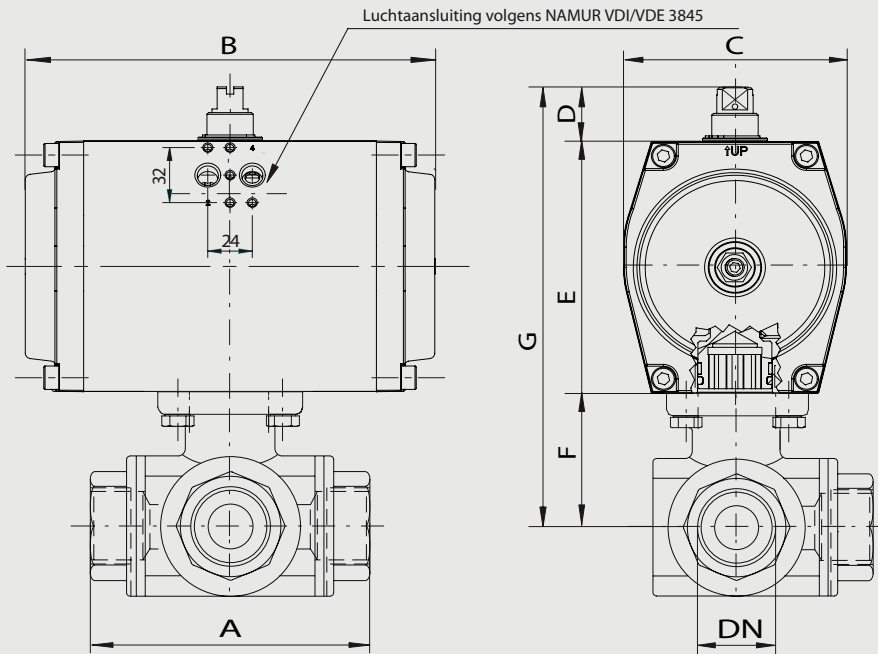

Double-acting ball valve, L4-bore with pipe threads

Nominal[mm] connection[mm]		max. press. [bar] PN	M(1) +30% [Nm]	Flange	Square	Kv	Pneumatic Actuator	Dimension [mm] and weight [kg]							Order Code	
DN	Rp							A	B	C	D	E	F	G		Weight
8	1/4	40	7,2	F03	9	5,9	GTKB-052x90	64,5	133	68,5	30	74	38	142	1,85	3P83050305
10	3/8	40	7,2	F03	9	9,4	GTKB-052x90	64,5	133	68,5	30	74	38	142	1,85	3P83050310
15	1/2	40	7,2	F03	9	17	GTKB-052x90	64,5	133	68,5	30	74	38	142	1,90	3P83050315
20	3/4	40	8,5	F03	9	41	GTKB-052x90	76	133	68,5	30	74	42	146	2,10	3P83050320
25	1	40	12,5	F03/F04	9	70	GTKB-052x90	97	133	68,5	30	74	46,5	150,5	2,8	3P83050325
32	1.1/4	40	19,5	F04/F05	11	121	GTKB-052x90	118	133	68,5	30	74	61,5	165,5	4,0	3P83050330
40	1.1/2	25	32,5	F04/F05	11	200	GTKB-063x90	135	137	80	30	88	63,5	181,5	5,6	3P83050335
50	2	25	43,0	F05	14	292	GTKB-075x90	157	161	92,5	30	100	74	204	9,3	3P83050340

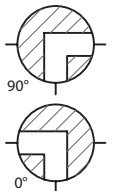

Double-acting ball valve, T1-bore with pipe threads

Nominal[mm] connection[mm]		max. press. [bar] PN	M(1) +30% [Nm]	Flange	Square	Kv	Pneumatic Actuator	Dimension [mm] and weight [kg]							Order Code	
DN	Rp							A	B	C	D	E	F	G		Weight
8	1/4	40	7,2	F03	9	5,9	GTKB-052x90	64,5	133	68,5	30	74	38	142	1,85	3P83050405
10	3/8	40	7,2	F03	9	9,4	GTKB-052x90	64,5	133	68,5	30	74	38	142	1,85	3P83050410
15	1/2	40	7,2	F03	9	17	GTKB-052x90	64,5	133	68,5	30	74	38	142	1,90	3P83050415
20	3/4	40	8,5	F03	9	41	GTKB-052x90	76	133	68,5	30	74	42	146	2,10	3P83050420
25	1	40	12,5	F03/F04	9	70	GTKB-052x90	97	133	68,5	30	74	46,5	150,5	2,8	3P83050425
32	1.1/4	40	19,5	F04/F05	11	121	GTKB-052x90	118	133	68,5	30	74	61,5	165,5	4,0	3P83050430
40	1.1/2	25	32,5	F04/F05	11	200	GTKB-063x90	135	137	80	30	88	63,5	181,5	5,6	3P83050435
50	2	25	43,0	F05	14	292	GTKB-075x90	157	161	92,5	30	100	74	204	9,3	3P83050440

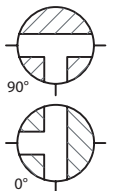

P8305

Double-acting ball valve, T2-bore with pipe threads

Nominal[mm] connection[mm]		max. press. [bar] PN	M(1) +30% [Nm]	Flange	Squa- re	Kv	Pneumatic Actu- ator	Dimension [mm] and weight [kg]							Order Code	
DN	Rp							A	B	C	D	E	F	G		Weight
8	1/4	40	7,2	F03	9	5,9	GTKB-052x90	64,5	133	68,5	30	74	38	142	1,85	3P83050505
10	3/8	40	7,2	F03	9	9,4	GTKB-052x90	64,5	133	68,5	30	74	38	142	1,85	3P83050510
15	1/2	40	7,2	F03	9	17	GTKB-052x90	64,5	133	68,5	30	74	38	142	1,90	3P83050515
20	3/4	40	8,5	F03	9	41	GTKB-052x90	76	133	68,5	30	74	42	146	2,10	3P83050520
25	1	40	12,5	F03/F04	9	70	GTKB-052x90	97	133	68,5	30	74	46,5	150,5	2,8	3P83050525
32	1.1/4	40	19,5	F04/F05	11	121	GTKB-052x90	118	133	68,5	30	74	61,5	165,5	4,0	3P83050530
40	1.1/2	25	32,5	F04/F05	11	200	GTKB-063x90	135	137	80	30	88	63,5	181,5	5,6	3P83050535
50	2	25	43,0	F05	14	292	GTKB-075x90	157	161	92,5	30	100	74	204	9,3	3P83050540

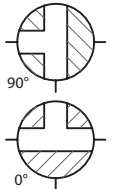

Double-acting ball valve, T3-bore with pipe threads

Nominal[mm] connection[mm]		max. press. [bar] PN	M(1) +30% [Nm]	Flange	Squa- re	Kv	Pneumatic Actu- ator	Dimension [mm] and weight [kg]							Order Code	
DN	Rp							A	B	C	D	E	F	G		Weight
8	1/4	40	7,2	F03	9	5,9	GTKB-052x90	64,5	133	68,5	30	74	38	142	1,85	3P83050605
10	3/8	40	7,2	F03	9	9,4	GTKB-052x90	64,5	133	68,5	30	74	38	142	1,85	3P83050610
15	1/2	40	7,2	F03	9	17	GTKB-052x90	64,5	133	68,5	30	74	38	142	1,90	3P83050615
20	3/4	40	8,5	F03	9	41	GTKB-052x90	76	133	68,5	30	74	42	146	2,10	3P83050620
25	1	40	12,5	F03/F04	9	70	GTKB-052x90	97	133	68,5	30	74	46,5	150,5	2,8	3P83050625
32	1.1/4	40	19,5	F04/F05	11	121	GTKB-052x90	118	133	68,5	30	74	61,5	165,5	4,0	3P83050630
40	1.1/2	25	32,5	F04/F05	11	200	GTKB-063x90	135	137	80	30	88	63,5	181,5	5,6	3P83050635
50	2	25	43,0	F05	14	292	GTKB-075x90	157	161	92,5	30	100	74	204	9,3	3P83050640

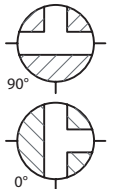

Single-acting ball valve, L4-bore with pipe threads

Nominal[mm] connection[mm]		max. press. [bar] PN	M(1) +30% [Nm]	Flange	Squa- re	Kv	Pneumatic Actu- ator	Dimension [mm] and weight [kg]							Order Code	
DN	Rp							A	B	C	D	E	F	G		Weight
8	1/4	40	7,2	F03	9	5,9	GTKB-052x90/08	64,5	133	68,5	30	74	38	142	1,85	3P83050705
10	3/8	40	7,2	F03	9	9,4	GTKB-052x90/08	64,5	133	68,5	30	74	38	142	1,83	3P83050710
15	1/2	40	7,2	F03	9	17	GTKB-052x90/08	64,5	133	68,5	30	74	38	142	1,80	3P83050715
20	3/4	40	8,5	F03	9	41	GTKB-063x90/08	76	137	80	30	88	42	160	2,8	3P83050720
25	1	40	12,5	F03/F04	9	70	GTKB-075x90/08	97	161	92,5	30	100	46,5	176,5	4,45	3P83050725
32	1.1/4	40	19,5	F04/F05	11	121	GTKB-075x90/08	118	161	92,5	30	100	61,5	191,5	5,65	3P83050730
40	1.1/2	25	32,5	F04/F05	11	200	GTKB-083x90/09	135	180	92,5	30	100	63,5	193,5	7,0	3P83050735
50	2	25	43,0	F05	14	292	GTKB-092x90/09	157	209	110,5	30	117	74	221	11,3	3P83050740

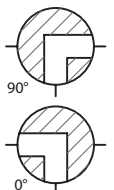

Pneumatically operated
3-Way
Brass Nickel Plated ball valve

P8305

Single-acting ball valve, T1-bore with pipe threads

Nominal[mm] connection[mm]		max. press. [bar] PN	M(1) +30% [Nm]	Flange	Squa- re	Kv	Pneumatic Actu- ator	Dimension [mm] and weight [kg]							Order Code	
DN	Rp							A	B	C	D	E	F	G		Weight
8	1/4	40	7,2	F03	9	5,9	GTKB-052x90/08	64,5	133	68,5	30	74	38	142	1,85	3P83050805
10	3/8	40	7,2	F03	9	9,4	GTKB-052x90/08	64,5	133	68,5	30	74	38	142	1,83	3P83050810
15	1/2	40	7,2	F03	9	17	GTKB-052x90/08	64,5	133	68,5	30	74	38	142	1,80	3P83050815
20	3/4	40	8,5	F03	9	41	GTKB-063x90/08	76	137	80	30	88	42	160	2,8	3P83050820
25	1	40	12,5	F03/F04	9	70	GTKB-075x90/08	97	161	92,5	30	100	46,5	176,5	4,45	3P83050825
32	1.1/4	40	19,5	F04/F05	11	121	GTKB-075x90/08	118	161	92,5	30	100	61,5	191,5	5,65	3P83050830
40	1.1/2	25	32,5	F04/F05	11	200	GTKB-083x90/09	135	180	92,5	30	100	63,5	193,5	7,0	3P83050835
50	2	25	43,0	F05	14	292	GTKB-092x90/09	157	209	110,5	30	117	74	221	11,3	3P83050840

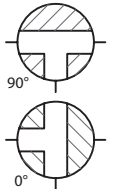

Single-acting ball valve, T2-bore with pipe threads

Nominal[mm] connection[mm]		max. press. [bar] PN	M(1) +30% [Nm]	Flange	Squa- re	Kv	Pneumatic Actu- ator	Dimension [mm] and weight [kg]							Order Code	
DN	Rp							A	B	C	D	E	F	G		Weight
8	1/4	40	7,2	F03	9	5,9	GTKB-052x90/08	64,5	133	68,5	30	74	38	142	1,85	3P83050905
10	3/8	40	7,2	F03	9	9,4	GTKB-052x90/08	64,5	133	68,5	30	74	38	142	1,83	3P83050910
15	1/2	40	7,2	F03	9	17	GTKB-052x90/08	64,5	133	68,5	30	74	38	142	1,80	3P83050915
20	3/4	40	8,5	F03	9	41	GTKB-063x90/08	76	137	80	30	88	42	160	2,8	3P83050920
25	1	40	12,5	F03/F04	9	70	GTKB-075x90/08	97	161	92,5	30	100	46,5	176,5	4,45	3P83050925
32	1.1/4	40	19,5	F04/F05	11	121	GTKB-075x90/08	118	161	92,5	30	100	61,5	191,5	5,65	3P83050930
40	1.1/2	25	32,5	F04/F05	11	200	GTKB-083x90/09	135	180	92,5	30	100	63,5	193,5	7,0	3P83050935
50	2	25	43,0	F05	14	292	GTKB-092x90/09	157	209	110,5	30	117	74	221	11,3	3P83050940

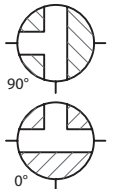

Single-acting ball valve, T3-bore with pipe threads

Nominal[mm] connection[mm]		max. press. [bar] PN	M(1) +30% [Nm]	Flange	Squa- re	Kv	Pneumatic Actu- ator	Dimension [mm] and weight [kg]							Order Code	
DN	Rp							A	B	C	D	E	F	G		Weight
8	1/4	40	7,2	F03	9	5,9	GTKB-052x90/08	64,5	133	68,5	30	74	38	142	1,85	3P83051005
10	3/8	40	7,2	F03	9	9,4	GTKB-052x90/08	64,5	133	68,5	30	74	38	142	1,83	3P83051010
15	1/2	40	7,2	F03	9	17	GTKB-052x90/08	64,5	133	68,5	30	74	38	142	1,80	3P83051015
20	3/4	40	8,5	F03	9	41	GTKB-063x90/08	76	137	80	30	88	42	160	2,8	3P83051020
25	1	40	12,5	F03/F04	9	70	GTKB-075x90/08	97	161	92,5	30	100	46,5	176,5	4,45	3P83051025
32	1.1/4	40	19,5	F04/F05	11	121	GTKB-075x90/08	118	161	92,5	30	100	61,5	191,5	5,65	3P83051030
40	1.1/2	25	32,5	F04/F05	11	200	GTKB-083x90/09	135	180	92,5	30	100	63,5	193,5	7,0	3P83051035
50	2	25	43,0	F05	14	292	GTKB-092x90/09	157	209	110,5	30	117	74	221	11,3	3P83051040

