



H8005

Robuuste, handbediende 3-Weg
messing vernikkelde kogelkraan met ISO-Top
t.b.v opbouw actuator met L of T boring

DOORLAAT

DN08 (1/4") tot DN50 (2")

AANSLUITING

- Binnendraad volgens UNI EN 10226 (DIN ISO 7/1)
- Opbouwflens volgens ISO 5211

BEDRIJFSDRUK

Van PN40 (1/4) tot PN25 (2")

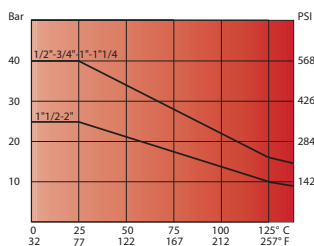

TEMPERATUUR BEREIK

Van -20° tot +130°C

MATERIALEN

Huis: Messing CW 617 N UNI EN 12165
Kogel: Messing, hardverchromd CW 614 N UNI EN 12164
Kogelafdichting: PTFE
As: Messing, hardverchromd CW 614 N UNI EN 12164
As afdichting: PTFE
O-Ring: Elastomeer
Stopbuswartel: Messing CW

DOORSTROMINGSRICHTING

Naar keuze.

MONTAGE

Raadpleeg aanbeveling voor inbouw industriële afsluiters.

MEDIUM

Neutrale gassen en vloeistoffen. Voor toepassingen met agressieve media bestendigheidstabel raadplegen. Bepaalde media kunnen het draaimoment verhogen.

BEDIENING (Standaard)







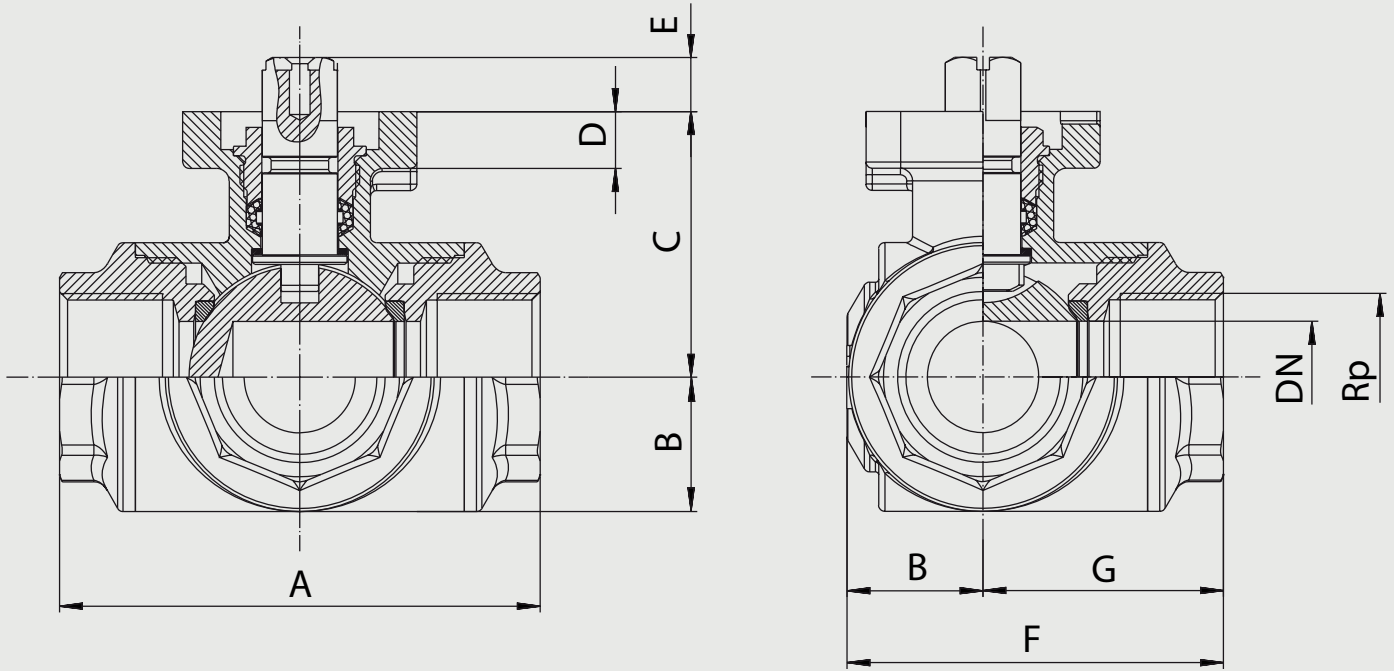









Vrij as

OPTIES EN TOEBEHOREN

Hendel



Boring en schakelbeeld dubbelwerkend

Boring	T				L			
90°								
0°								
L	T1 = 04	T2 = 05	T3 = 06	L4 = 03				

Kogelkraan 3-weg L-boring met gasdraad, ISO Top en hendel

Doorlaat[mm] aansluiting[mm]		max. druk [bar]	M(1) +30% [Nm]	Flens	4-kant	Kv	Inbouwmaat [mm] en gewicht [kg]								Bestelcode
DN	Rp	PN					A	B	C	D	E	F	G	Gewicht	
8	1/4	40	7,2	F03	9	5,9	64,5	17	38	9	9	49,5	32,5	1,850	3H80050305
10	3/8	40	7,2	F03	9	9,4	64,5	17	38	9	9	49,5	32,5	1,850	3H80050310
15	1/2	40	7,2	F03	9	17	64,5	17	38	9	9	49,5	32,5	1,900	3H80050315
20	3/4	40	8,5	F03	9	41	76	21,5	42	9	9	59,7	38	2,100	3H80050320
25	1	40	12,5	F03/F04	9	70	97	26	46,5	9	9	74,5	48,5	2,800	3H80050325
32	1.1/4	40	19,5	F04/F05	11	121	118	36	61,5	10	11	95,2	59	4,000	3H80050330
40	1.1/2	25	32,5	F04/F05	11	200	135	37,5	63,5	10	11	105	67,5	5,600	3H80050335
50	2	25	43	F05	14	292	157	43	74	12	14	121,5	78,5	9,300	3H80050340

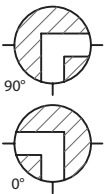

Kogelkraan 3-weg T-boring met gasdraad, ISO Top en hendel

Doorlaat[mm] aansluiting[mm]		max. druk [bar] PN	M(1) +30% [Nm]	Flens	4-kant	Kv	Inbouwmaat [mm] en gewicht [kg]							Bestelcode	
DN	Rp						A	B	C	D	E	F	G		Gewicht
8	1/4	40	7,2	F03	9	5,9	64,5	17	38	9	9	49,5	32,5	1,850	3H80050405
10	3/8	40	7,2	F03	9	9,4	64,5	17	38	9	9	49,5	32,5	1,830	3H80050410
15	1/2	40	7,2	F03	9	17	64,5	17	38	9	9	49,5	32,5	1,800	3H80050415
20	3/4	40	8,5	F03	9	41	76	21,5	42	9	9	59,7	38	2,800	3H80050420
25	1	40	12,5	F03/F04	9	70	97	26	46,5	9	9	74,5	48,5	4,450	3H80050425
32	1.1/4	40	19,5	F04/F05	11	121	118	36	61,5	10	11	95,2	59	6,650	3H80050430
40	1.1/2	25	32,5	F04/F05	11	200	135	37,5	63,5	10	11	105	67,5	7,000	3H80050435
50	2	25	43	F05	14	292	157	43	74	12	14	121,5	78,51	11,300	3H80050440

